

KRAFTWERK®
FAVORITE TOOLS SINCE 1979

PT LINE

BT LINE

LT LINE

PT 1000

 **MADE IN GERMANY**

ab Seite 8

WERKSTATTWAGEN

2024

Gültigkeitsdauer 01.04.2024 - 31.01.2025



**NEUES
PRODUKT**

450 kg Nutzlast
(dynamisch)



Lösungsmittel-
beständige
Edelstahl-
arbeitsfläche



Ergonomischer Griff mit
rutschfester Grifffläche,
KRAFTWERK-DESIGN



Zentralverriegelung
aller Schubladen durch
Zylinderschloss an
geschützter Stelle im
Griff



Seitenwände mit
perforiertem
Lochwandraster für
optimale Kompa-
tibilität mit unseren
Hakensystemen



Rundum-
Stoßkantenschutz aus
ABS und TPR



Mit zwei Bockrollen sowie
zwei Lenkrollen mit
Feststellern

Ablagemöglich-
keiten auf der
Arbeitsfläche,
intelligente
Raumnutzung durch
zusätzliche kleine
Seitenschubladen
beidseitig zum
Verstauen von
persönlichen
Gegenständen



7 kugelgelagerte
Schubladen mit
Vollauszug und
je 45 kg Nutzlast



360° Protection
auch bei
geöffneter
Schublade durch
Schubladen-
Eckverkleidung

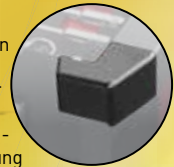

Kippschutz
(Verhindert das gleich-
zeitige Öffnen von
mehreren Schubladen)



Art. 101.417.000	L1	L2	L3	ΣTD
	800 mm	479 mm	1000 mm	450 kg
L4	600 mm	400 mm	73 mm	45 kg
L5	600 mm	400 mm	152 mm	45 kg



Art. 102.417.001

PRO LINE Werkstattwagen PT800, 7 Schubladen, 103-tlg.

MADE IN GERMANY

103 hochwertige Werkzeuge in EVA Werkzeug-Einlegeshalen

1/4" + 1/2" Umschaltknarren, Bits und Verlängerungen

1/4" Steckschlüsseleinsätze (6kt.): 3.5 - 14 mm

1/2" Steckschlüsseleinsätze (6kt.): 10 - 34 mm

Ring-Maulschlüssel: 8 - 19 mm

Zangen-Sortiment

Schlagwerkzeuge

PROLINE Schlitz-Schraubendreher 4 mm - 8 mm, PH1 + PH2

CHF 1'849.-



**NEUE
PRODUKTE**

Art. 102.417.101

PRO LINE Werkstattwagen PT800 7, Schubladen, PB, 197-tlg.

MADE IN GERMANY

- 197 hochwertige Werkzeuge in 7 EVA Werkzeug-Einlegeshalen
- Ring-Maulschlüssel: 5.5 - 24 mm
- 1/4" + 3/8" + 1/2" Umschaltknarren und Verlängerungen
- 1/4" Steckschlüsseleinsätze (6kt.): 3.5 - 14 mm
- 3/8" Steckschlüsseleinsätze (6kt.): 8 - 24 mm
- 1/2" Steckschlüsseleinsätze (6kt.): 10 - 32 mm
- Zangen-Sortiment
- PB SWISS Schraubendrehersatz mit PH1-PH2, Schlitz 0.5 x 3.5 mm - 1.2 x 8 mm, Bithalter und TX-TR-Bits
- Schlag- und Schneidwerkzeuge
- Feilen-Satz



CHF 2'290.-



PRO LINE

Art. 102.417.007

PRO LINE Werkstattwagen PT800, 7 Schubladen, 238-tlg.

MADE IN GERMANY

- 238 hochwertige Werkzeuge in 10 EVA Werkzeug-Einlegeshalen
- Ring-Maulschlüssel: 5.5 - 24 mm
- 1/4" + 3/8" + 1/2" Umschaltknarren und Verlängerungen
- 1/4" Steckschlüsseleinsätze (6kt.): 3.5 - 14 mm
- 3/8" Steckschlüsseleinsätze (6kt.): 8 - 24 mm
- 1/2" Steckschlüsseleinsätze (6kt.): 10 - 32 mm
- 1/2" Innensechskant Schraubendreher-Steckschlüsseleinsätze, 55 mm: 5 - 10 mm
- 1/2" Vielzahn Schraubendreher-Steckschlüsseleinsätze, 55 mm: M5 - M12
- 1/2" Innensechskant Schraubendreher-Steckschlüsseleinsätze, 100 mm: 6 - 12 mm
- 1/2" Vielzahn Schraubendreher-Steckschlüsseleinsätze, 100 mm: M5 - M10
- Zangen-Sortiment
- PROLINE Schlitz-Schraubendreher 4 mm - 8 mm, PH1 + PH2
- Schlag- und Schneidwerkzeuge
- Feilen-Satz



PRO LINE



CHF 2'390.-



Art. 102.417.005

PRO LINE Werkstattwagen PT800, 7 Schubladen, 189-tlg.



CHF 2'190.-

Art. 102.417.004

PRO LINE Werkstattwagen PT800, 7 Schubladen, 220-tlg.

MADE IN GERMANY

Ring-Maulschlüssel: 5.5 - 24 mm

1/4" + 3/8" + 1/2" Umschaltknarren und Verlängerungen

1/4" Steckschlüsseleinsätze (6kt.): 3.5 - 14 mm

3/8" Steckschlüsseleinsätze (6kt.): 8 - 24 mm

1/2" Steckschlüsseleinsätze (6kt.): 10 - 32 mm

1/2" Bit-Steckschlüsseleinsätze TX, Innensechskant, Vielzahl

Zangen-Sortiment

PROLINE Schlitz-Schraubendreher 4 mm - 8 mm, PH1 + PH2, TX

Schlagwerkzeuge

CHF **2'390.-**



PRO LINE



Art. 101.417.000	L1	L2	L3	Σ	
	800 mm	479 mm	1000 mm	450 kg	
	L4	600 mm	400 mm	73 mm	45 kg
	L5	600 mm	400 mm	152 mm	45 kg



PRO LINE

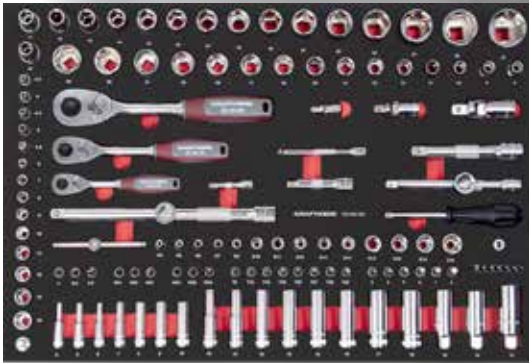

CHF **2'539.-**



Art. 102.417.006

PRO LINE Werkstattwagen PT800, 7 Schubladen, 274-tlg.

MADE IN GERMANY

274 hochwertige Werkzeuge in EVA Werkzeugeinlagen

Ring-Maulschlüssel: 5.5 - 24 mm

1/4" + 3/8" + 1/2" Umschaltknarren und Verlängerungen

1/4" Steckschlüsseleinsätze (6kt.): 3.5 - 14 mm

3/8" Steckschlüsseleinsätze (6kt.): 8 - 24 mm

1/2" Steckschlüsseleinsätze (6kt.): 10 - 32 mm

Zangensatz

Winkelstiftschlüssel-Sortiment

Seegerring-Zangensatz

PROLINE Schlitz-Schraubendreher 4 mm - 8 mm, PH1 + PH2

Gripzangensatz und Blechschere

Schlag- und Schneidwerkzeuge

Feilen-Satz



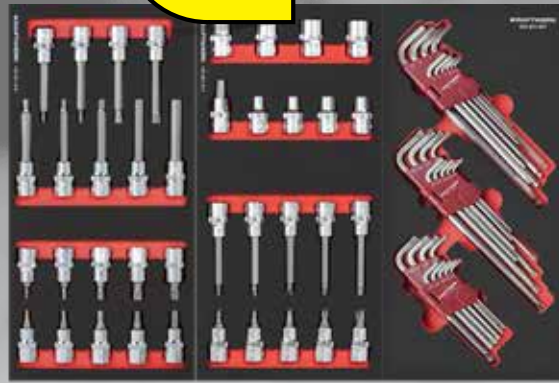
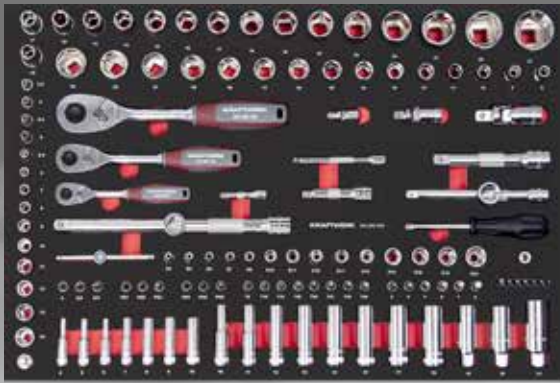

PRO LINE

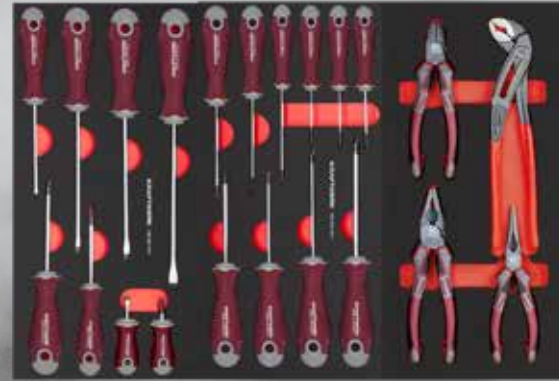

CHF 2'590.-

Art. 102.417.010

**PRO LINE
Werkstattwagen PT800,
7 Schubladen, 283-tlg.**



CHF 2'640.-



Art. 102.417.009

PRO LINE Werkstattwagen PT800, 7 Schubladen, 283-tlg.

MADE IN GERMANY

- 283 hochwertige Werkzeuge in EVA Werkzeugeinlagen
- 1/4" + 3/8" + 1/2" Umschaltknarren und Verlängerungen
- 1/4" Steckschlüsseleinsätze (6kt.): 3.5 - 14 mm
- 3/8" Steckschlüsseleinsätze (6kt.): 8 - 24 mm
- 1/2" Steckschlüsseleinsätze (6kt.): 10 - 32 mm
- Ring-Maulschlüssel: 5.5 - 24 mm
- Ratschen Ringmaulschlüssel: 8- 24 mm
- Seegerring-Zangensatz
- 1/2" Bit-Steckschlüsselsatz TX, innensechskant
- PROLINE Schlitz-Schraubendreher 4 mm - 8 mm, PH1 + PH2, TX
- Schlag- und Schneidwerkzeuge
- Zangen- und Winkelstiftschlüssel-Sortiment



Art. 102.417.106

**PRO LINE Werkstattwagen PT800,
7 Schubladen, PB, 290-tlg.**

CHF 2'850.-

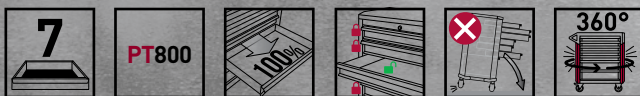

Art. 101.417.000	L1	L2	L3	ΔT	
	800 mm	479 mm	1000 mm	450 kg	
	L4	600 mm	400 mm	73 mm	45 kg
	L5	600 mm	400 mm	152 mm	45 kg





**NEUE
PRODUKTE**

Art. 102.417.110

PRO LINE

PRO LINE Werkstattwagen PT800, 7 Schubladen, PB, 151-tlg.

MADE IN GERMANY

151 hochwertige Werkzeuge in 9 speziell hochverdichteten Weich-Schaumstoff-Einlagen (EVA) 20 x 40 cm

Steckschlüsselsatz 1/2" mit Steckschlüsseleinsätzen:

10 - 34 mm, Verlängerungen + Gelenkstück

Steckschlüsselsatz 1/4" mit Steckschlüsseleinsätzen

3.5 - 14 mm,

PH1-PH3, PZ1-PZ3, TX T8-T40, Innensechskant 3-8 mm

Ringmaulschlüsselsatz 8-24 mm

Zangen-/Scheren Satz

Schneidwerkzeug-satz

Schlagwerkzeugsatz mit Schlosser- + Kunststoffhammer

PB SWISS Schraubendrehersatz mit PH1-PH2, Schlitz

0,5 x 3,5 mm - 1,2 x 8 mm, Bithalter und TX-TR-Bits

Feilensatz 11-tlg.



Art. 102.550.502

**PRO LINE
Werkstattwagen PT800,
7 Schubladen, 143-tlg.**



CHF **1'990.-**

CHF **2'090.-**

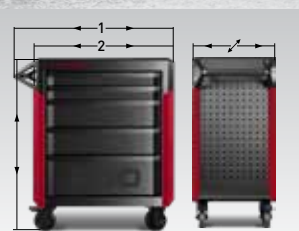

Art. 101.415.000



Art. 101.417.000

**LEERE
WERKSTATTWAGEN**

Art.	↑ mm	↔ 1 mm	↔ 2 mm	↘ mm	kg	—	— mm 400 x 600 mm	CHF	kg	Δ kg
101.415.000	1000	919	800	479	450	5	1 x 225; 2 x 75; 2 x 160 mm	1'250.-	45	78
101.417.000	1000	919	800	479	450	7	2 x 150; 5 x 75 mm	1'270.-	45	87



**NEUES
PRODUKT**

450 kg Nutzlast
(dynamisch)



Lösungsmittel-
beständige
Edelstahl-
arbeitsfläche



Ergonomischer Griff mit
rutschfester Grifffläche,
KRAFTWERK-DESIGN



Zentralverriegelung
aller Schubladen durch
Zylinderschloss an
geschützter Stelle im
Griff



Seitenwände mit
perforiertem
Lochwandraster für
optimale Kompa-
tibilität mit unseren
Hakensystemen



Rundum-
Stoßkantenschutz aus
ABS und **TPR**



Ablagemöglich-
keiten auf der
Arbeitsfläche,
intelligente
Raumnutzung durch
zusätzliche kleine
Seitenschubladen
beidseitig zum
Verstauen von
persönlichen
Gegenständen



7 kugelgelagerte
Schubladen mit
Vollauszug und
je 45 kg Nutzlast



360° Protection
auch bei
geöffneter
Schublade durch
Schubladen-
Eckverkleidung



Kippschutz
(Verhindert das gleich-
zeitige Öffnen von
mehreren Schubladen)

Mit zwei Bockrollen sowie
zwei Lenkrollen mit
Feststellern



PT 1000

Art. 101.517.000	L1	L2	L3	ΔD
	1000mm	479 mm	1000mm	450 kg
L4	800 mm	400 mm	73 mm	45 kg
L5	800 mm	400 mm	152 mm	45 kg

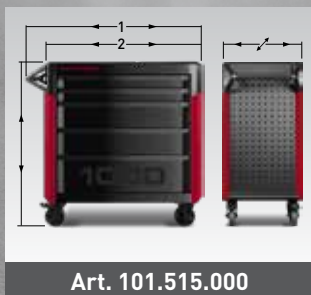

Art. 101.515.000

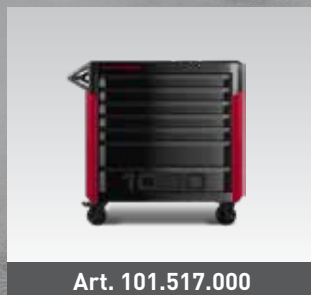

Art. 101.517.000

**LEERE
WERKSTATTWAGEN**

Art.	↑ mm	↖ mm	↗ mm	↘ mm	⬇ Kg	▬	▬ ↑ mm ↕ 400 x 600 mm	CHF	⬇ Kg	ΔD kg
101.515.000	1000	1119	1000	479	450	5	1 x 225; 2 x 75; 2 x 160 mm	1'590.-	45	78
101.517.000	1000	1119	1000	479	450	7	2 x 150; 5 x 75 mm	1'690.-	45	87

Art. 102.517.005

PRO LINE Werkstattwagen PT1000, 7 Schubladen, 221-tlg.

MADE IN GERMANY

221 hochwertige Werkzeuge in EVA Werkzeugeinlagen

Ring-Maulschlüssel: 5.5 - 32 mm

1/4" + 3/8" + 1/2" Umschaltknarren Bits und Verlängerungen

1/4" Steckschlüsseleinsätze (6kt.): 3.5 - 14 mm

3/8" Steckschlüsseleinsätze (6kt.): 8 - 24 mm

1/2" Steckschlüsseleinsätze (6kt.): 10 - 32 mm

1/2" Innensechskant Schraubendreher-Steckschlüsseleinsätze: 5 - 12 mm

1/2" Vielzahn Schraubendreher-Steckschlüsseleinsätze: M5 - M12

Zangen-Sortiment

PROLINE Schraubendreher-Sortiment Schlitz, TX, PH

Schlag- und Schneidwerkzeuge



CHF 2'790.-



PRO LINE

Art. 102.517.006

PRO LINE Werkstattwagen PT1000, 7 Schubladen, 261-tlg.

MADE IN GERMANY

261 hochwertige Werkzeuge in EVA Werkzeugeinlagen

Ring-Maulschlüssel: 5.5 - 24 mm

1/4" + 3/8" + 1/2" Umschaltknarren und Verlängerungen

1/4" Steckschlüsseleinsätze (6kt.): 3.5 - 14 mm

3/8" Steckschlüsseleinsätze (6kt.): 8 - 24 mm

1/2" Steckschlüsseleinsätze (6kt.): 10 - 32 mm

Zangensatz

Winkelstiftschlüssel-Sortiment

Seegerring-Zangensatz

PROLINE Schraubendreher-Sortiment

Schlitz 4 - 8 mm, PH1 + PH2

Gripzangensatz und Blechschere

Schlag- und Schneidwerkzeuge

Feilen-Satz

CHF 3'450.-



PRO LINE





Art. 102.381.517

BT LINE Werkstattwagen BT700, 7 Schubladen, 189-tlg.

MADE IN GERMANY

189 hochwertige Werkstatt-Werkzeuge in 7 EVA Werkzeug-Einlegeschalen
 Ring-Maulschlüssel: 5.5 - 24 mm
 1/4" + 3/8" + 1/2" Umschaltknarren und Verlängerungen
 1/4" Steckschlüsseleinsätze (6kt.): 3.5 - 14 mm
 3/8" Steckschlüsseleinsätze (6kt.): 8 - 24 mm
 1/2" Steckschlüsseleinsätze (6kt.): 10 - 32 mm
 Zangen-Sortiment
 PROLINE Schlitz-Schraubendreher
 4 mm - 8 mm, PH1 + PH2
 Schlag- und Schneidwerkzeuge

CHF 1'599.-



Art. 101.117.100	L1	L2	L3	ΔT
	719 mm	474 mm	1000 mm	450 kg
	L4: 600 mm	400 mm	75 mm	45 kg
	L5: 600 mm	400 mm	150 mm	45 kg



PRO LINE

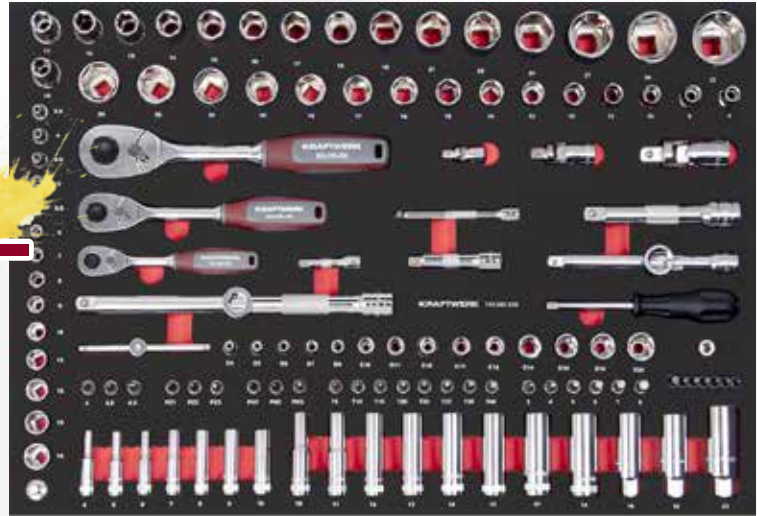

Art. 102.350.516

BT LINE Werkzeugtruhe BT700, 3 Schubladen, 189-tlg.

MADE IN GERMANY

189 hochwertige Werkstatt-Werkzeuge in 7 EVA Werkzeug-Einlegeschalen
 Ring-Maulschlüssel: 5.5 - 24 mm
 1/4" + 3/8" + 1/2" Umschaltknarren und Verlängerungen
 1/4" Steckschlüsseleinsätze (6kt.): 3.5 - 14 mm
 3/8" Steckschlüsseleinsätze (6kt.): 8 - 24 mm
 1/2" Steckschlüsseleinsätze (6kt.): 10 - 32 mm
 Zangen-Sortiment
 PROLINE Schlitz-Schraubendreher
 4 mm - 8 mm, PH1 + PH2
 Schlag- und Schneidwerkzeuge

CHF 1'349.-



Lieferung ohne Abdeckung

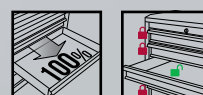

Art. 101.900.003	L1	L2	L3	ΔT
	719 mm	474 mm	369 mm	420 kg
	L4: 600 mm	400 mm	75 mm	45 kg



Art. 102.470.509

BT LINE Werkstattwagen BT700, 8 Schubladen, 236-tlg.

MADE IN GERMANY

236 hochwertige Werkzeuge in 15 EVA Werkzeug-Einlegeschaln
 Ring-Maulschlüssel: 5,5 - 24 mm
 1/4" + 3/8" + 1/2" Umschaltknarren und Verlängerungen
 1/4" Steckschlüsseleinsätze (6kt.): 3,5 - 14 mm
 3/8" Steckschlüsseleinsätze (6kt.): 8 - 24 mm
 1/2" Steckschlüsseleinsätze (6kt.): 10 - 34 mm
 PROLINE Schlitz-Schraubendreher 4 mm - 8 mm, PH1 + PH2, TX
 Schlag- und Schneidwerkzeuge
 Feilen-Satz

PRO LINE



CHF **2'190.-**



Art. 102.470.515

BT LINE Werkstattwagen BT700, 8 Schubladen, 242-tlg.

MADE IN GERMANY

242 hochwertige Werkzeuge in 9 speziell hochverdichteten EVA Weich-Schaumstoff-Einlagen
 Ring-Maulschlüssel: 5,5 - 32 mm
 1/4" + 3/8" + 1/2" Umschaltknarren und Verlängerungen
 1/4" Steckschlüsseleinsätze (6kt.): 3,5 - 14 mm
 3/8" Steckschlüsseleinsätze (6kt.): 8 - 24 mm
 1/2" Steckschlüsseleinsätze (6kt.): 10 - 32 mm
 Inkl. Art. 3235 Drehmomentschlüssel 1/2", 40-200 Nm
 Zangen-Sortiment
 PROLINE Schlitz-Schraubendreher 4 mm - 8 mm, PH1 + PH2, TX
 Schlag-, Mess- und Schneidwerkzeug-Sortiment
 Feilen-Satz

PRO LINE



CHF **2'390.-**



Art. 102.470.516

BT LINE Werkstattwagen BT700, 8 Schubladen, 243-tlg.



CHF **2'390.-**

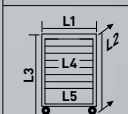

Art. 101.118.100	L1	L2	L3	ØD
	719 mm	474 mm	1000 mm	450 kg
L4	600 mm	400 mm	75 mm	45 kg
L5	600 mm	400 mm	150 mm	45 kg





Art. 102.470.518

BT LINE Werkstattwagen BT700, 8 Schubladen, 250-tlg.

MADE IN GERMANY
250 hochwertige Werkzeuge in 9 EVA Werkzeug-Einlegeshalen
Ring-Maulschlüssel: 5.5 - 32 mm
Industrie-Rollgabelschlüssel 150 und 200 mm
Kugelkopf-Innensechskantschlüssel: 1.5 - 10 mm
TX- Winkelstiftschlüssel: T10 - T50
1/2" Drehmomentschlüssel 40 - 200 Nm
1/4" + 3/8" + 1/2" Umschaltknarren und Verlängerungen
1/4" Steckschlüsseleinsätze (6kt.): 3.5 - 14 mm
3/8" Steckschlüsseleinsätze (6kt.): 10 - 17 mm
1/2" Steckschlüsseleinsätze (6kt.): 10 - 34 mm
KNIPEX Zangen-Sortiment
PB Schraubendreher Schlitz: 0.5 x 3.5 mm - 1.2 x 8 mm,
PH: PH1 - PH2, TX: TX8 - TX40
1/4" PB Bithalter inkl. TR10 - TR40 Bits und Spannungsprüfer
Schlag- und Schneidwerkzeuge
Feilenset 11-tlg.

PRO LINE



CHF 2'550.-



Art. 102.460.516

BT LINE Werkstattwagen BT700, 7 Schubladen, 198-tlg.

MADE IN GERMANY
198 hochwertige Werkzeuge in 7 EVA Werkzeug-Einlegeshalen
Ring-Maulschlüssel: 5.5 - 24 mm
1/4" + 3/8" + 1/2" Umschaltknarren und Verlängerungen
1/4" Steckschlüsseleinsätze (6kt.): 3.5 - 14 mm
3/8" Steckschlüsseleinsätze (6kt.): 8 - 24 mm
1/2" Steckschlüsseleinsätze (6kt.): 10 - 32 mm
KNIPEX Zangen-Sortiment
PB Schraubendreher Schlitz: 0.5 x 3.5 mm - 1.2 x 8 mm,
PH: PH1 - PH2, TX: TX8 - TX40
1/4" PB Bithalter inkl. TR10 - TR40 Bits und Spannungsprüfer
Schlag- und Schneidwerkzeuge
Feilenset 11-tlg.

PRO LINE

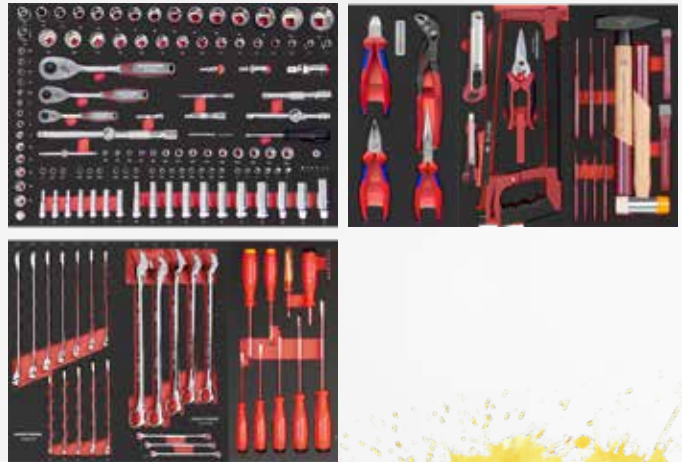

CHF 1'750.-



Art. 101.117.100	L1	L2	L3	ΔΔ	
	L1	719 mm	474 mm	1000 mm	450 kg
	L4	600 mm	400 mm	75 mm	45 kg
	L5	600 mm	400 mm	150 mm	45 kg





CHF 1'749.-

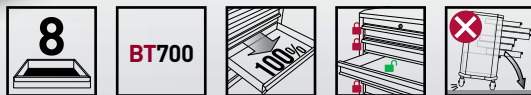

Art. 101.118.100	L1	L2	L3	ΣG
	719 mm	474 mm	1000 mm	450 kg
	L4 600 mm	400 mm	75 mm	45 kg
	L5 600 mm	400 mm	150 mm	45 kg

Art. 102.118.101

BT LINE Werkstattwagen BT700, 8 Schubladen, 143-tlg.

MADE IN GERMANY

143 hochwertige Werkzeuge in 9 EVA Werkzeug-Einlegesohlen

Ring-Maulschlüssel: 5.5 - 24 mm

1/4" + 1/2" Umschaltknarren und Verlängerungen

1/4" Steckschlüsseleinsätze (6kt.): 3.5 - 13 mm

1/2" Steckschlüsseleinsätze (6kt.): 1 - 34 mm

Zangen-Sortiment

PROLINE Schlitz-Schraubendreher 4 mm - 8 mm, PH1 + PH2

Schlag- und Schneidwerkzeuge

Feilen-Satz



PRO LINE



Seitenwände mit Vierkantlochung
Einfaches Befestigen von Zubehör

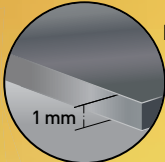

Konstruktion
Sehr stabile doppelwandige Stahlblechkonstruktion



2 Lenkrollen mit Bremse und 2 starre Rollen
Thermoplastisches Gummirad, Kunststofffelge

Seitliche Zentralverriegelung
aller Schubladen durch Zylinder-schloss



Kippschutz
Gleichzeitiges Öffnen mehrerer Schubladen nicht möglich

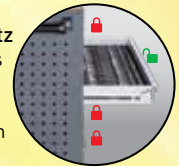

Grössere und stabilere Schubladen
Verstärkte Schubladen und Schubladenführungen mit Vollauszug

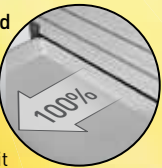

Art. 102.117.103

BT LINE Werkstattwagen BT700, 7 Schubladen, 337-tlg.

MADE IN GERMANY
337 hochwertige Werkstatt-Werkzeuge in 4 EVA Werkzeug-Einlegeshalen
Ring-Maulschlüssel: 6 - 22 mm
1/4" + 1/2" Umschaltknarren und Verlängerungen
1/4" Steckschlüsseleinsätze (6kt.): 4 - 14 mm
1/2" Steckschlüsseleinsätze (6kt.): 10 - 32 mm
Optional Art. 3235 Drehmomentschlüssel 1/2", 40 - 200 Nm
Kugelkopf-Innensechskant-Winkelstiftschlüssel-Satz: 1.5 - 10 mm, 9-tlg.
TX-Winkelstiftschlüssel-Satz: T10 - T50, 9-tlg.
Feilen-Satz
Schraubendreher-Sortiment
Schlag- und Schneidwerkzeug
Zangen-Sortiment

Art. 101.117.100	L1	L2	L3	ΣTD
	719 mm	474 mm	1000 mm	450 kg
L4	600 mm	400 mm	75 mm	45 kg
L5	600 mm	400 mm	150 mm	45 kg

CHF 1'249.-





Art. 102.117.104

BT LINE Werkstattwagen BT700, 7 Schubladen, 301-tlg.

MADE IN GERMANY

301 hochwertige Werkstatt-Werkzeuge in 6 EVA Werkzeug-Einlegeschaalen

Ring-Maulschlüssel: 5.5 - 24 mm

Doppelringschlüssel, tief gekröpft: 6 - 22 mm

1/4" + 3/8" + 1/2" Umschaltknarren und Verlängerungen

1/4" Steckschlüsseleinsätze (6kt.): 4 - 14 mm

3/8" Steckschlüsseleinsätze (6kt.): 10 - 24 mm

1/2" Steckschlüsseleinsätze (6kt.): 14 - 32 mm

5/16" + 1/4" Schraubendreher-Bits

Schlitz-, PH-, PZ-, Innensechskant-, Vielzahn-, TX- und TX-TR-

Schraubendreher-Steckschlüsseleinsätze

Kugelkopf-Innensechskant-Winkelstiftschlüssel-Satz: 1.5 - 10 mm, 9-tlg.

TX-Winkelstiftschlüssel-Satz: T10 - T50, 9-tlg.

Feilen-Satz

Schraubendreher-Sortiment

Schlag- und Schneidwerkzeug

Zangen-Sortiment



CHF **1'649.-**



Art. 102.117.106

BT LINE Werkstattwagen BT700, 7 Schubladen, 274-tlg.

MADE IN GERMANY

274 hochwertige Werkstatt-Werkzeuge in 5 EVA Werkzeug-Einlegeschaalen

Ring-Maulschlüssel: 5.5 - 24 mm

Doppelringschlüssel, tief gekröpft: 6 - 22 mm

1/4" + 3/8" + 1/2" Umschaltknarren und Verlängerungen

1/4" Steckschlüsseleinsätze (6kt.): 4 - 14 mm

3/8" Steckschlüsseleinsätze (6kt.): 10 - 24 mm

1/2" Steckschlüsseleinsätze (6kt.): 14 - 32 mm

5/16" + 1/4" Schraubendreher-Bits

Schlitz-, PH-, PZ-, Innensechskant-, Vielzahn-, TX- und TX-TR-

Schraubendreher-Steckschlüsseleinsätze

Kugelkopf-Innensechskant-Winkelstiftschlüssel-Satz: 1.5 - 10 mm, 9-tlg.

TX-Winkelstiftschlüssel-Satz: T10 - T50, 9-tlg.

Schraubendreher-Sortiment

Zangen-Sortiment



CHF **1'599.-**



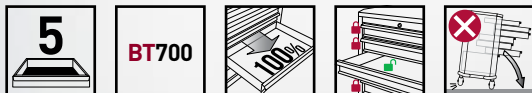
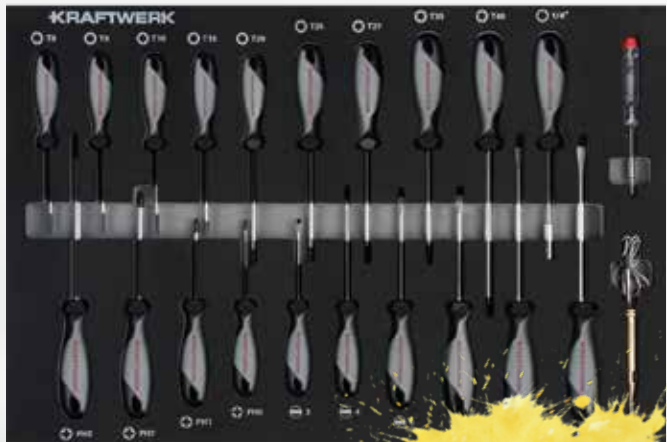
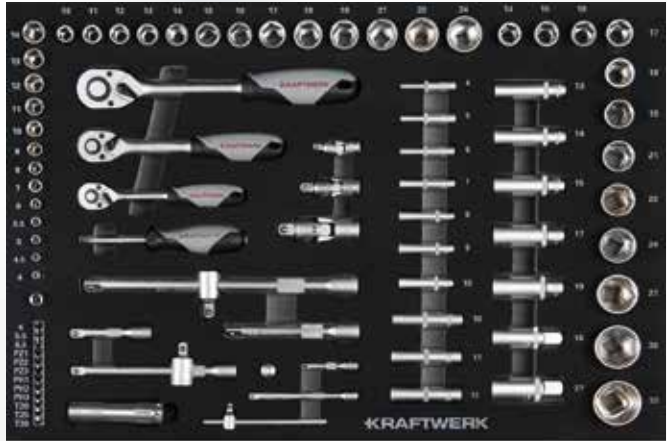

Art. 101.115.100	L1	L2	L3	ΔD
	719 mm	474 mm	1000 mm	450 kg
L4	600 mm	400 mm	75 mm	45 kg
L5	600 mm	400 mm	150 mm	45 kg
L6	600 mm	400 mm	225 mm	45 kg

CHF 1'199.-

Art. 102.115.100

BT LINE Werkstattwagen BT700, 5 Schubladen, 154-tlg.

MADE IN GERMANY

154 hochwertige Werkstatt-Werkzeuge in 3 EVA Werkzeug-Einlegesohlen

Ring-Maulschlüssel: 5.5 - 24mm

Doppelringschlüssel, tief gekröpft: 6 x 7 - 20 x 22mm

1/4" + 3/8" + 1/2" Umschaltknarren und Verlängerungen

1/4" Steckschlüsseleinsätze (6kt.): 4 - 14 mm

3/8" Steckschlüsseleinsätze (6kt.): 10 - 24 mm

1/2" Steckschlüsseleinsätze (6kt.): 14 - 32 mm

3/8" Zündkerzen-Steckschlüsseleinsätze: 16 + 21 mm

1/4" Schraubendreher-Bits

Kugelkopf-Innensechskant-Winkelstiftschlüssel-Satz: 1.5 - 10 mm, 9-tlg.

TX-Winkelstiftschlüssel-Satz: T10 - T50, 9-tlg.

Verschiedene Adapter

Taschenlampe

Schraubendreher-Sortiment

Phasenprüfer 110-250V, GS-geprüft



Seitenwände mit Vierkantlochung
Einfaches Befestigen von Zubehör

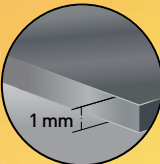

Konstruktion
Sehr stabile doppelwandige Stahlblechkonstruktion



2 Lenkrollen mit Bremse und 2 starre Rollen
Thermoplastisches Gummirad, Kunststofffelge

Seitliche Zentralverriegelung
aller Schubladen durch Zylinder-schloss



Kippschutz
Gleichzeitiges Öffnen mehrerer Schubladen nicht möglich

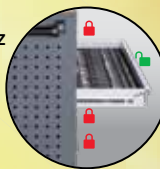

Grössere und stabilere Schubladen
Verstärkte Schubladen und Schubladenführungen mit Vollauszug

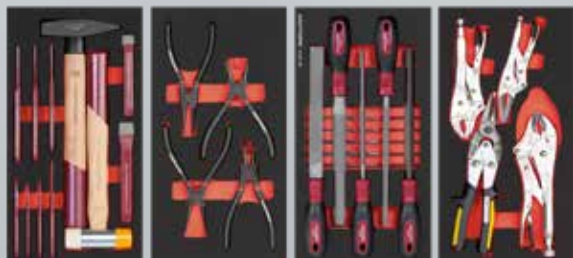
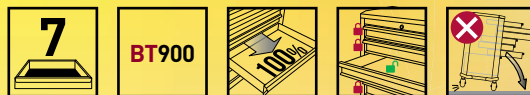
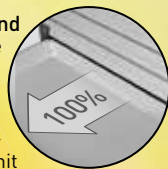

PRO LINE



CHF **2'699.-**

Art. 101.217.100	L1	L2	L3	ΣTD	
	919 mm	474 mm	1000 mm	450 kg	
	L4	800 mm	400 mm	75 mm	45 kg
	L5	800 mm	400 mm	150 mm	45 kg



Art. 102.217.200

SWISS LINE Werkstattwagen BT900, 7 Schubladen, PB, 226-tlg.

- Werkzeuge in 16 speziell hochverdichteten Weich-Schaumstoff-Einlagen (EVA) 20x40 cm
- 1/4" + 3/8" + 1/2" Umschaltknarren, 72 Zahn
- PH 1 - 3, PZ 1 - 3, TX, Innensechskant 3 - 8 mm,
- Steckschlüsseleinsätze TX T8 - T40
- Steckschlüsseleinsätze: 3,5 - 34 mm
- Steckschlüsseleinsätze, lange Ausführung: 10 - 19 mm
- Zündkerzen-Steckschlüsseleinsätze: 16 + 21 mm
- Kardangelenk
- Zangensatz
- Gripzangen-/Blechscher
- Seegerringzangen
- Schneid-/Schlag-/Trennwerkzeuge
- Ringmaulschlüsselsatz 5,5 - 24 mm
- Doppelringschlüsselsatz 6 - 22 mm
- Ratschen-Ringmaulschlüsselsatz 8 - 19 mm
- PB Phasenprüfer 0.5 x 2.5 mm 50 mm
- PB Schlitz-Schraubendreher 3.5 mm - 8 mm
- PB PH-Schraubendreher PH1 + PH2
- Universal-Bithalter PB 1/4"
- Feilen-satz

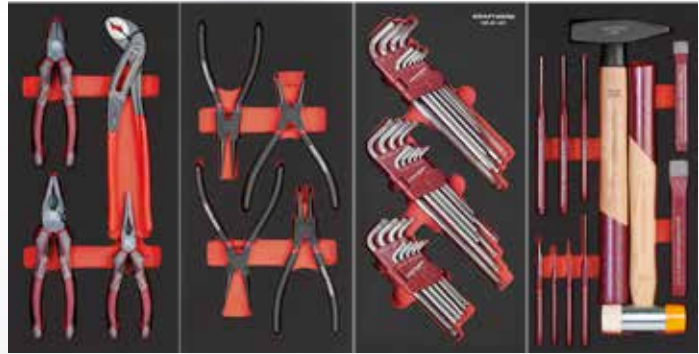

PRO LINE



Art. 102.217.201

BT LINE Werkstattwagen BT900, 7 Schubladen, 244-tlg.

- Werkzeuge in 10 speziell hochverdichteten Weich-Schaumstoff-Einlagen (EVA) 60 & 20x40 cm
- 1/4"+3/8"+1/2" Umschaltknarren
- 1/4" Steckschlüsseleinsätze (6kt.): 3.5 - 14 mm, lange Ausführung: 4 - 10 mm
- 1/4" Schlitz-Steckschlüsseleinsätze: 4 - 6.5 mm
- Steckschlüsseleinsätze: PH1 - PH3
- PZ1 - PZ3, T8 - T40, TR10 - TR40
- 1/4" Innensechskant 3 - 8 mm
- 1/4" Außen TX Steckschlüsseleinsätze: E4 - E11
- 3/8" Steckschlüsseleinsätze (6kt.): 8 - 24 mm
- 3/8" Steckschlüsseleinsätze, lange Ausführung (6kt.): 10 - 19 mm
- 3/8" Außen TX Steckschlüsseleinsätze: E10 - E20
- 3/8" Zündkerzen-Steckschlüsseleinsätze: 16 - 18 - 21 mm
- 1/2" Steckschlüsseleinsätze (6kt.): 10 - 32 mm
- Zangensatz + Seegerringzangen
- Schlag-/Trennwerkzeuge
- Ringmaulschlüsselsatz 5,5 - 24 mm
- PROLINE Schlitz-Schraubendreher 4 mm - 8 mm, PH1 + PH2
- PROLINE TX Schraubendreher TX7 - TX40
- Innensechskant, TX, TX-TR - Winkelstiftschlüsselsatz



CHF 2'299.-

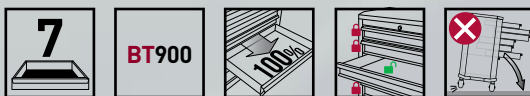

Art. 101.217.100	L1	L2	L3	ΔΣ	
		919 mm	474 mm	1000 mm	450 kg
	L4	800 mm	400 mm	75 mm	45 kg
	L5	800 mm	400 mm	150 mm	45 kg



PRO LINE



CHF **2'899.-**

Art. 102.217.202

BT LINE Werkstattwagen BT900, 7 Schubladen, 278-tlg.

Werkzeuge in 12 speziell hochverdichteten Weich-Schaumstoff-Einlagen (EVA) 60 & 20x40 cm

- 1/4"+3/8"+1/2" Umschaltknarren
- 1/4" Steckschlüsseleinsätze (6kt.): 3.5 - 14 mm, lange Ausführung: 4 - 10 mm
- 1/4" Schlitz-Steckschlüsseleinsätze: 4 - 6.5 mm
- Steckschlüsseleinsätze: PH1 - PH3
- PZ1 - PZ3, T8 - T40, TR10 - TR40
- 1/4" Innensechskant 3 - 8 mm
- 1/4" Außen TX Steckschlüsseleinsätze: E4 - E11
- 3/8" Steckschlüsseleinsätze (6kt.): 8 - 24 mm
- 3/8" Steckschlüsseleinsätze, lange Ausführung (6kt.): 10 - 19 mm
- 3/8" Außen TX Steckschlüsseleinsätze: E10 - E20
- 3/8" Zündkerzen-Steckschlüsseleinsätze: 16 - 18 - 21 mm
- 1/2" Steckschlüsseleinsätze (6kt.): 10 - 32 mm
- Zangensatz + Seegerringzangen
- Schlag-/Trennwerkzeuge
- Ringmaulschlüsselsatz 5,5 - 24 mm
- Ratschen-Ringmaulschlüsselsatz 8 - 19 mm
- PROLINE Schlitz-Schraubendreher 4 mm - 8 mm
- PROLINE PH Schraubendreher PH1 + PH2
- PROLINE TX Schraubendreher TX7- TX40
- Innensechskant, TX, TX-TR - Winkelstiftschlüsselsatz
- Blechscherer, Grip- & Klemmzangen

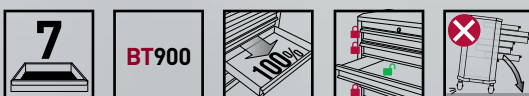

Art. 101.217.100	L1	L2	L3	ΔT	
	L1	919 mm	474 mm	1000 mm	450 kg
	L4	800 mm	400 mm	75 mm	45 kg
	L5	800 mm	400 mm	150 mm	45 kg



Seitenwände mit Vierkantlochung
Einfaches Befestigen von Zubehör

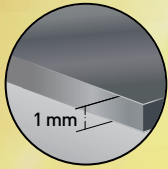

Konstruktion
Sehr stabile doppelwandige Stahlblechkonstruktion



2 Lenkrollen mit Bremse und 2 starre Rollen
Thermoplastisches Gummirad, Kunststofffelge

Seitliche Zentralverriegelung
aller Schubladen durch Zylinderschloss



Kippschutz
Gleichzeitiges Öffnen mehrerer Schubladen nicht möglich

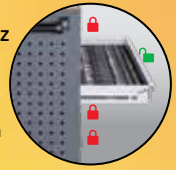

Grössere und stabilere Schubladen
Verstärkte Schubladen und Schubladenfürungen mit Vollauszug

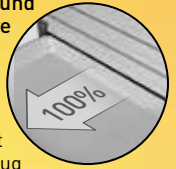

Schrank mit Fachboden, 25 kg belastbar

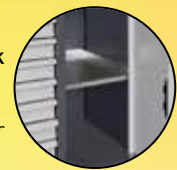

Art. 101.317.100	L1	L2	L3	Σ
	1119 mm	474 mm	1000 mm	450 kg
L4	600 mm	400 mm	75 mm	45 kg
L5	600 mm	400 mm	150 mm	45 kg



BT700

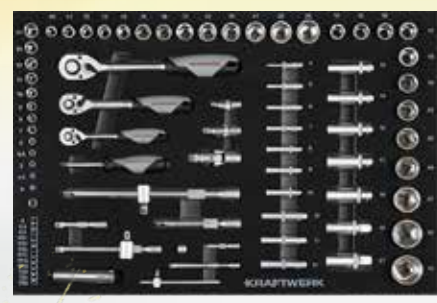
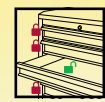
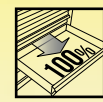

CHF 2'399.-

Art. 102.317.100

BASIC LINE Werkstattwagen BT1100, 7 Schubladen, 300-tlg.

MADE IN GERMANY
300 hochwertige Werkzeuge in 8 speziell hochverdichteten Weich-Schaumstoff-Einlagen (EVA)
Ring-Maulschlüssel: 5,5 - 24 mm
Doppelringschlüssel, tief gekröpft: 6 - 22 mm
1/4" + 3/8" + 1/2" Umschaltknarren und Verlängerungen
1/4" Steckschlüsseleinsätze (6kt.): 4 - 14 mm
3/8" Steckschlüsseleinsätze (6kt.): 10 - 24 mm
1/2" Steckschlüsseleinsätze (6kt.): 14 - 32 mm
Schlitz-, PH-, PZ-, Innensechskant-, Vielzahn-, TX- und TX-TR-Schraubendreher-Steckschlüsseleinsätze
Schlitz-, PH-, PH- und TX-Bit-Schraubendreher
Zangen-Sortiment
Schraubendreher-Sortiment Schlitz, PH, TX
Schlag- und Schneidwerkzeug



Seitliche Zentralverriegelung
 aller Schubladen durch Zylinderschloss



Kippschutz
 Gleichzeitiges Öffnen mehrerer Schubladen nicht möglich

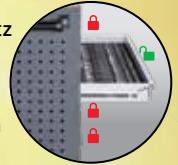

Größere und stabilere Schubladen
 Verstärkte Schubladen und Schubladenföhrungen mit Vollauszug

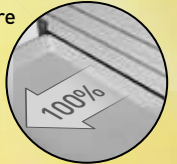

Seitenwände mit Vierkantlochung
 Einfaches Befestigen von Zubehör



Konstruktion
 Sehr stabile doppelwandige Stahlblechkonstruktion

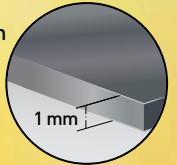

2 Lenkrollen mit Bremse und 2 starre Rollen
 Thermoplastisches Gummirad, Kunststofffelge



Schrank mit Fachboden,
 25 kg belastbar



Art. 101.401.000		L1	L2	L3	ΔT
		1805 mm	470 mm	1000 mm	450 kg
L4	600 mm	400 mm	75 mm	45 kg	
L5	600 mm	400 mm	150 mm	45 kg	
L6	600 mm	400 mm	240 mm	45 kg	
L7	365 mm	465 mm	720 mm	45 kg	

CHF **3'790.-**

Art. 101.401.001

BASIC LINE Werkstattwagen BT1800, 13 Schubladen, 395-tlg.

MADE IN GERMANY

395 hochwertige Werkzeuge in 17 speziell hochverdichteten Weich-Schaumstoff-Einlagen (EVA)

Schlag-, & Messwerkzeuge, Schraubendreher, Feilen, Zangen

1/4", 3/8", 1/2" Steckschlüsseleinsätze 4 - 14 mm, 10 - 19 mm, 10 - 32 mm

1/2" Steckschlüsseleinsätze Innensechskant & Vielzahn

3/8" Innensechskant Schraubendreher-Steckschlüsseleinsätze, 90 mm: 3 - 10 mm

3/8" TX Schraubendreher-Steckschlüsseleinsätze, 90 mm: T8 - T50

3/8" Vielzahn Schraubendreher-Steckschlüsseleinsätze, 90 mm: M5 - M12

3/8" RIBE® Schraubendreher-Steckschlüsseleinsätze, 90 mm: M5 - M12

1/2" Schlag-Steckschlüsseleinsätze, lange Ausführung (6kt.): 13 - 32 mm

1/2" Schlag-Steckschlüsseleinsätze, lange Ausführung (12kt.): 30 + 36 mm

Ring-Maulschlüssel / Ring-Ringschlüssel 5,5 - 24 mm

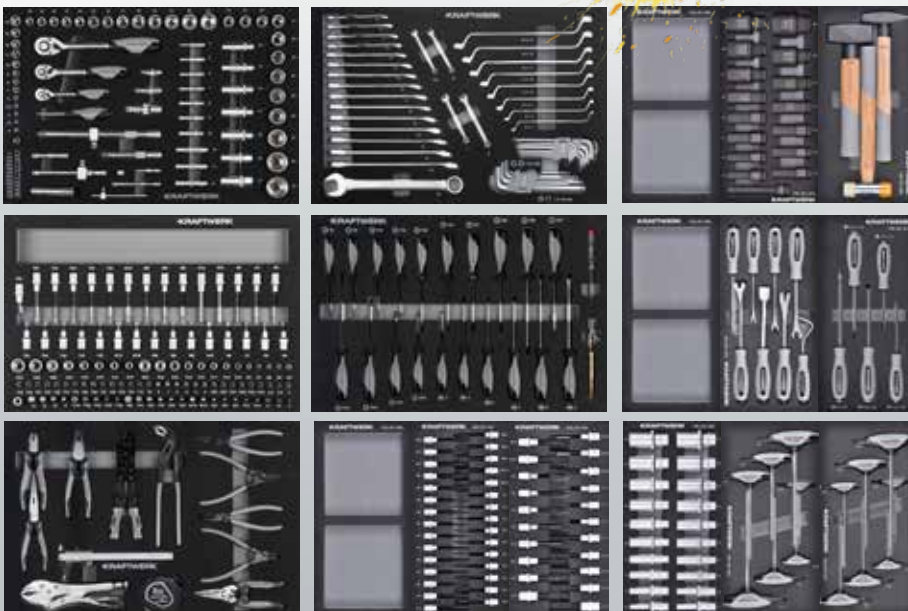

Art. 102.117.430

VDE Werkstattwagen BT700, 7 Schubladen, mit VDE Werkzeug, 116-tlg.

MADE IN GERMANY
116 hochwertige Werkstatt-Werkzeuge in 5 EVA Werkzeug-Einlegeschalen
Satz Warn- und Sicherheitsschilder Hochspannung
3/8" VDE Umschaltknarre
3/8" VDE Steckschlüsseleinsätze (6kt.): 8 - 22 mm
VDE T-Griff Sechskantschlüssel: 4 - 14 mm
VDE Maulschlüssel: 8 - 19 mm
VDE Schlitz-Schraubendreher 2.5 - 8 mm
VDE PH-Schraubendreher: PH0 - PH3
VDE PZ-Schraubendreher: PZ0 - PZ3
VDE TX-Schraubendreher: T6 - T45
VDE Innensechskant-Schraubendreher: 2.5 - 8 mm
Spannungsprüfer
VDE Zange

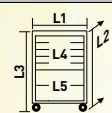

CHF **1'899.-**

Art. 101.117.101	L1	L2	L3	ΔD
	719 mm	474 mm	1000 mm	450 kg
L4	600 mm	400 mm	75 mm	45 kg
L5	600 mm	400 mm	150 mm	45 kg

Art. 102.117.431

VDE Werkstattwagen BT700, 7 Schubladen, mit VDE Werkzeug, 124-tlg.

MADE IN GERMANY
124 hochwertige Werkstatt-Werkzeuge in 5 EVA Werkzeug-Einlegeschalen
Satz Warn- und Sicherheitsschilder Hochspannung
3/8" VDE Umschaltknarre
3/8" VDE Steckschlüsseleinsätze (6kt.): 8 - 22 mm
VDE T-Griff Sechskantschlüssel: 4 - 14 mm
VDE Maulschlüssel: 8 - 19 mm
VDE Schlitz-Schraubendreher: 2.5 - 8 mm
VDE PH-Schraubendreher: PH0 - PH3
VDE PZ-Schraubendreher: PZ0 - PZ3
VDE TX-Schraubendreher: T6 - T45
VDE Innensechskant-Schraubendreher: 2.5 - 8 mm
Spannungsprüfer
VDE Zange
Gurtbandkassetten
Absperrränder

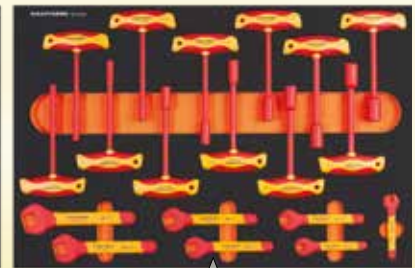
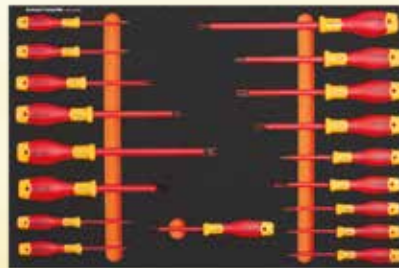
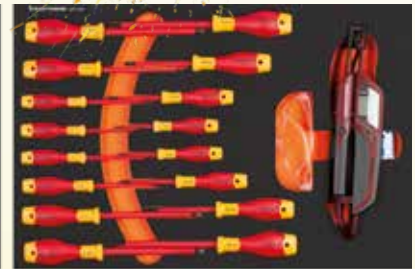

CHF **2'899.-**



Art. 105.110.001

VDE Schraubendreher-Einlage, 16-tlg.

VDE Schlitz-Schraubendreher:
2.5 - 3 - 3.5 - 4 - 5.5 - 6.5 - 7 - 8 mm
VDE PH-Schraubendreher: PH0 - PH1 - PH2 - PH3
VDE PZ-Schraubendreher: PZ0 - PZ1 - PZ2 - PZ3
Optional mit Sicherheitsbrille 807.000.001 und
Spannungsprüfer 311.000.000

CHF **139.-**

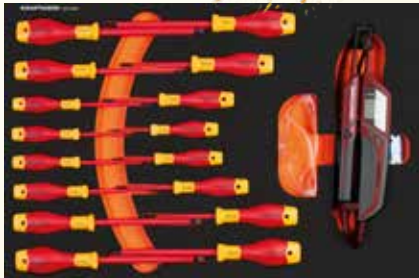

Art. 105.110.002

VDE Schraubendreher-Einlage, 18-tlg.

VDE TX-Schraubendreher:
T6 - T7 - T8 - T9 - T10 - T15 - T20 - T25 - T27 -
T30 - T40 - T45
VDE Innensechskant-Schraubendreher:
2.5 - 3 - 4 - 5 - 6 - 8 mm

CHF **185.-**

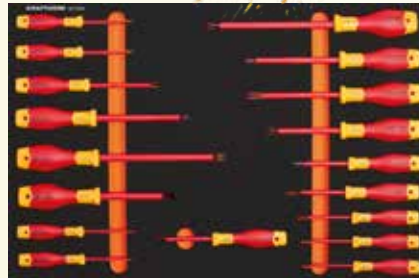

Art. 105.110.004

VDE Einmaul- und T-Griff Steckschlüssel-Einlage, 19-tlg.

VDE T-Griff-Steckschlüssel:
4 - 5 - 5.5 - 6 - 7 - 8 - 9 - 10 - 11 - 12 - 13 - 14 mm
VDE Einmaulschlüssel:
8 - 10 - 12 - 13 - 14 - 17 - 19 mm

CHF **429.-**

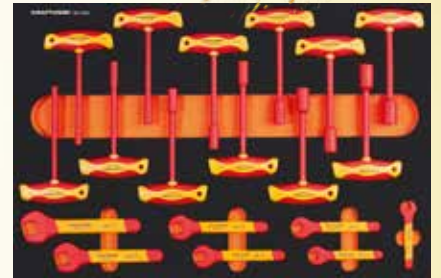

Art. 105.110.003

VDE Steckschlüssel- und Zangen-Einlage, 18-tlg.

3/8" VDE Umschaltknarre
3/8" VDE-Steckschlüsseleinsätze: (6kt.):
8 - 10 - 12 - 13 - 14 - 17 - 19 - 22 mm
VDE Kombizange: 180 mm / 7"
VDE Seitenschneider: 160 mm / 6.1/2"
VDE Flachrundzange: 200 mm / 8"
VDE Abisolierzange: 160 mm / 6.1/2"
VDE Messer
VDE Schere

CHF **479.-**



Art. 510.100.000

"HIGH VOLTAGE" Sicherheits- und Warningschilder-Einlage, 38-tlg.

Sicherheitsschild dreieckig, 2x
Sicherheitsschild rund, 1x
Sicherheitsschild rechteckig mit Magnet, 2x
Sicherheitsschild rechteckig mit Haken, 6x
Sicherheitsschild Pyramide, 1x
Ersatzteil Haken, 4x
Saugnapf-Ersatzteil, 18x
Magnet-Ersatzteil, 4x

CHF **249.-**



Art. 107.000.100

Set Absperrständer + Gurtbandkassetten 8-tlg.

6 Absperrständer mit ausziehbaren
Gurtbandkassetten 3.6 m
1 m Höhe
Gelb / Schwarz
Gurtbandkassetten 2 stk.
Ausziehbar 4.5 m
Inkl. Befestigungsmaterial



CHF **1'100.-**



Art. 102.107.203

LT LINE Werkstattwagen LT700, 7 Schubladen, 337-tlg.

MADE IN GERMANY
337 hochwertige Werkstatt-Werkzeuge in 4 EVA Werkzeug-Einlegeschaln
Ring-Maulschlüssel von 6 - 22 mm
1/4" + 1/2" Umschaltknarren und Verlängerungen
1/4" Steckschlüsseleinsatz (6-kant): 4 - 14 mm
1/2" Steckschlüsseleinsatz (6-kant): 10 - 32 mm
1/4" Bit-Box
Kugelpf-Innensechskant-Winkelstiftschlüssel-Satz: 1.5 - 10 mm, 9-tlg.
TX-Winkelstiftschlüssel-Satz: T10 - T50, 9-tlg.
Feilen-Satz
Schraubendreher-Sortiment
Schlag- und Schneidwerkzeug
Zangen-Sortiment
Optional mit Art. 3235 1/2" Drehmomentschlüssel, 40-200 Nm



CHF **1'099.-**



Seitliche Zentralverriegelung aller Schubladen durch Zylinderschloss.



Kugelgelagerte Schubladen mit Vollauszug.



2 Lenkrollen mit Bremse und 2 starre Rollen
Thermoplastisches Gummirad, Kunststofffelge.

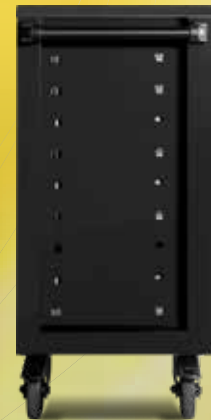

BTG
Back to Germany

Art. 101.107.200	L1	L2	L3	ΣTD	
	719 mm	474 mm	1000 mm	450 kg	
	L4	600 mm	400 mm	75 mm	45 kg
	L5	600 mm	400 mm	150 mm	45 kg

Art. 102.107.204

LT LINE Werkstattwagen LT700, 7 Schubladen, 301-tlg.

MADE IN GERMANY
301 hochwertige Werkzeuge in 6 speziell hochverdichteten Weich-Schaumstoff-Einlagen (EVA) 60 x 40 cm
Ring-Maulschlüssel von 5.5 - 24 mm
1/4"+3/8"+1/2" Umschaltknarren
1/4" Steckschlüsseleinsatz (6kt.): 4 - 14 mm
3/8" Steckschlüsseleinsatz (6kt.): 10 - 24 mm
1/2" Steckschlüsseleinsatz (6kt.): 14 - 32 mm
5/16" + 1/4" Schraubendreher-Bits
Schlitz-, PH-, PZ-, Innensechskant-, Vielzahn-, TX- und TX-TR-Schraubendreher-Steckschlüsseleinsätze
Kugelpf-Innensechskant-Winkelstiftschlüssel-Satz: 1.5 - 10 mm, 9-tlg.
TX-Winkelstiftschlüssel-Satz: T10 - T50, 9-tlg.
Feilen-Satz
Schraubendreher-Sortiment
Schlag- und Schneidwerkzeug
Zangen-Sortiment



CHF **1'499.-**





Art. 102.105.204

LT LINE Werkstattwagen LT700, 5 Schubladen, 259-tlg.

MADE IN GERMANY

259 hochwertige Werkzeuge in 3 speziell hochverdichteten Weich-Schaumstoff-Einlagen (EVA) 60 x 40 cm

Ring-Maulschlüssel: 6 - 22mm

1/4" + 1/2" Umschaltknarren und Verlängerungen

1/4" Steckschlüsseleinsätze (6-kant): 4 - 14 mm

1/2" Steckschlüsseleinsätze (6-kant): 10 - 32 mm

1/2" Zündkerzen-Steckschlüsseleinsätze: 16 + 21 mm

5/16" + 1/4" Schraubendreher-Bits

Verschiedene Adapter

Taschenlampe

Schraubendreher-Sortiment

Feilen-Satz

Schlag- und Schneidwerkzeug



CHF 999.-

Art. 102.105.203

LT LINE Werkstattwagen LT700, 5 Schubladen, 337-tlg.

MADE IN GERMANY

Grosse Auswahl an Werkzeugen für die Werkstatt, bestehend aus 337 Werkzeugen

Eingebettet in 4 Einlagen, weicher Schaumstoff mit hoher Dichte (EVA)

Ring-Maulschlüssel von 6 bis 22 mm

Umschaltknarren 1/4" + 1/2"

Steckschlüsseleinsätze 1/4" von 4 bis 14 mm

Steckschlüsseleinsätze 1/2" von 10 bis 32 mm

Optional mit Artikel 3235 Drehmomentschlüssel 1/2", 40 - 200 Nm

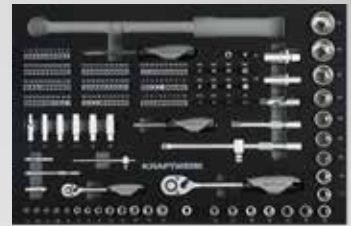

CHF 1'099.-



Art. 101.105.200	L1	L2	L3	Σ
	719 mm	474 mm	1000 mm	450 kg
L4	600 mm	400 mm	75 mm	45 kg
L5	600 mm	400 mm	150 mm	45 kg
L6	600 mm	400 mm	225 mm	45 kg

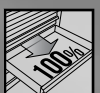



Art. 101.107.200	L1	L2	L3	Δ
	719 mm	474 mm	1000 mm	450 kg
	L4 600 mm	400 mm	75 mm	45 kg
	L5 600 mm	400 mm	150 mm	45 kg



Art. 102.107.205

LT LINE Werkstattwagen LT700, 7 Schubladen, 155-tlg.

- MADE IN GERMANY
- 155 hochwertige Werkstatt-Werkzeuge in 7 EVA Werkzeug-Einlegeshalen
- Ring-Maulschlüssel: 6 - 32 mm
- 1/4" + 1/2" Umschaltknarren und Verlängerungen
- 1/4" Steckschlüsseleinsätze (6kt.): 5 - 13 mm
- 1/2" Steckschlüsseleinsätze (6kt.): 8 - 32 mm
- 1/4" Aussen-TX Steckschlüsseleinsätze: E4 - E10
- 1/4" Innensechskant Schraubendreher-Steckschlüsseleinsätze: 3 - 8 mm
- 1/4" TX Schraubendreher-Steckschlüsseleinsätze: TX T6 - T40
- 1/4" TX-TR Schraubendreher-Steckschlüsseleinsätze mit Bohrung: TR6 - TR40
- 1/4" PH Schraubendreher-Steckschlüsseleinsätze: PH1 - PH2
- Zangen-Sortiment
- Schraubendreher-Sortiment
- Schlag- und Schneidwerkzeuge
- Feilen-Satz

CHF 1'029.-



Art. 101.105.200

Art. 101.107.200

Art. 101.103.200

Art.	↑ mm	↔ mm	↘ mm	Kg		mm 600 x 400 mm	CHF	Kg	Δ kg
101.105.200	1000	719	474	450	5	1 x 225; 2 x 150; 2 x 75 mm	549.-	45	57
101.107.200	1000	719	474	450	7	2 x 150; 5 x 75 mm	589.-	45	59
101.103.200	1000	700	400	450	3	1 x 225; 2 x 75;	539.-	45	55



**NEUES
PRODUKT**

Art. 102.103.201

**LT LINE Karosseriewagen LT700,
3 Schubladen, 121-tlg.**

MADE IN GERMANY

121 hochwertige Qualitätswerkzeuge für
Karosseriespengler & Blechbearbeitung

1/4" Steckschlüsselsatz

1/2" Steckschlüsselsatz

Ring-/Maulschlüsselset 8-19 mm

Schraubendreherst Schlit 4-8 mm +

PH 1 & 2

Schlagwerkzeugset

Zangenset

Kombizange, Seitenschneider, Flachrund-Zange,

Wasserpumpenzange, Abbrechmesser

3x Ausbeul- und Planierhammer gerade,

geriffelt, gewölbt

Handfaust Keilform

Handfaust Kommaform

Handfaust Zehenform gross

Karosserie-Feilenblatt radial 9, 12, 15 Zahn

Karosseriefeilen-Spannhalter

Karosserie-Löffeleisen

Karosserie-Meissel

Mini-Ausblaspistole mit Turbo-Power-Düse

Spann-, Schlicht- und Treibhammer



CHF 1'690.-

Art. 101.103.200	L1	L2	L3	ØD
	700 mm	400 mm	1000 mm	450 kg
L4	600 mm	400 mm	75 mm	45 kg
L5	600 mm	400 mm	150 mm	45 kg



**NEUES
PRODUKT**

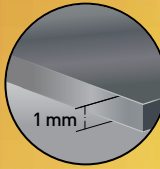

Konstruktion
Sehr stabile
doppelwandige
Stahlblech-
konstruktion



**Seitliche Zentral-
verriegelung**
aller Schubladen
durch Zylinder-
schloss

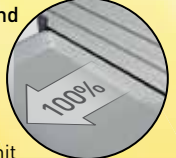

**Größere und
stabilere
Schubladen**
Verstärkte
Schubladen und
Schubladen-
führungen mit
Vollauszug



**2 Lenkrollen mit
Bremse und
2 starre Rollen**
Thermoplastisches
Gummirad,
Kunststofffelge



Art. 102.107.BLK2

BT LINE Werkstattwagen BT700s, 7 Schubladen, 113-tlg.

- MADE IN GERMANY
- 113 hochwertige Werkzeuge in 7 speziell hochverdichteten Weich-Schaumstoff-Einlagen (EVA) 20 x 40 cm
- 1/4" + 1/2" Umschaltknarren und Verlängerungen
- 1/4" Steckschlüsseleinsätze: 4 - 13 mm
- 1/2" Steckschlüsseleinsätze: 10 - 32 mm
- Ring-Maulschlüssel: 6 - 24 mm
- TX-Winkelstiftschlüssel-Satz: T10 - T50, 9-tlg.
- Schlitz Schraubendreher: 3 - 8 mm
- PH Schraubendreher: PH0 - PH1 - PH2
- TX Schraubendreher: T8 - T40
- T-Griff Winkelschraubendreher Innensechskant: 2.5 - 8 mm
- Schlag- / Schneidwerkzeuge
- Feilenset
- Zangenset

CHF 1'090.-

Art. 101.107.BLK	L1	L2	L3	ΣD
	719 mm	475 mm	1000 mm	450 kg
	L4 600 mm	400 mm	75 mm	45 kg
	L5 600 mm	400 mm	150 mm	45 kg

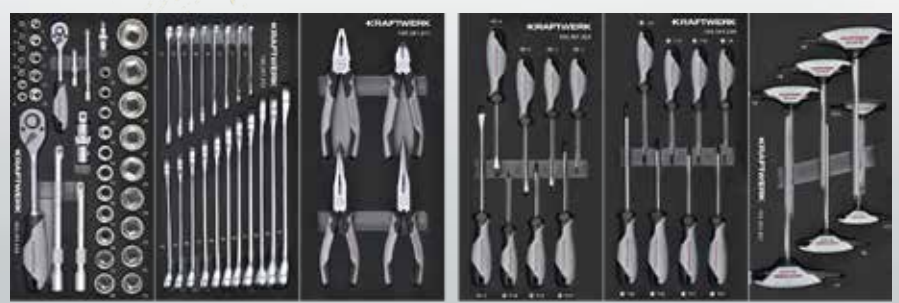

BASIC LINE



**NEUE
PRODUKTE**

Art. 102.107.BLK1

BT LINE Werkstattwagen BT700s, 7 Schubladen, 194-tlg.

MADE IN GERMANY

- 194 hochwertige Werkzeuge in 5 speziell hochverdichteten Weich-Schaumstoff-Einlagen (EVA) 60 x 40 cm
- 1/4" + 3/8" + 1/2" Umschaltknarren
- 1/4" Steckschlüsseinsätze: 4 - 14 mm
- 1/4" Steckschlüsseinsätze, lange Ausführung: 4 - 10 mm
- 1/4" Schraubendreher-Bits
- 3/8" Steckschlüsseinsätze: 10 - 24 mm
- 3/8" Steckschlüsseinsätze, lange Ausführung: 10 - 19 mm
- 3/8" Zündkerzen-Steckschlüsseinsätze: 16 + 21mm
- 1/2" Steckschlüsseinsätze: 14 - 32 mm
- Ring-Maulschlüssel: 5.5 - 24 mm
- Doppelringschlüssel, tief gekröpft: 6 x 7 - 20 x 22 mm
- Kugelpf-Innensechskant-Winkelstiftschlüssel-Satz: 1.5 - 10 mm, 9-tlg.
- TX-Winkelstiftschlüssel-Satz: T10 - T50, 9-tlg.
- Schlitz Schraubendreher: 3 - 8 mm
- PH Schraubendreher: PH0 - PH1 - PH2 - PH3
- TX Schraubendreher: T8 - T40
- Phasenprüfer
- Schlag- / Schneidwerkzeuge
- Feilenset
- Zangenset

CHF 1'170.-

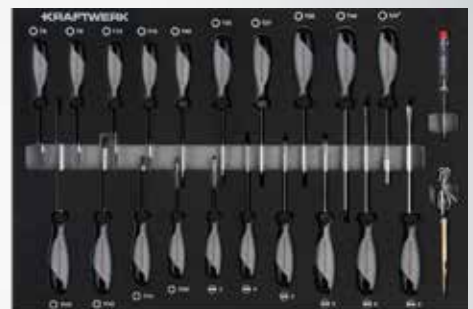

BASIC LINE

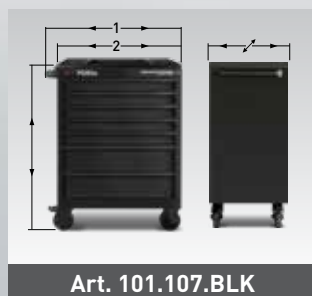

Art. 101.107.BLK

**LEERE
WERKSTATTWAGEN**

Art.	↑ mm	↔ mm	↔ mm	↘ mm	kg	▬	▬ ! mm	⊞ 400 x 600 mm	CHF	kg	Δ kg
101.107.BLK	1000	919	800	479	450	7	5 x 75; 2 x 160 mm		659.-	45	59



BT1800 BT LINE



Art. 101.401.000



**LEERE
WERKSTATTWAGEN**

Art.	↓ mm	↔ mm	↗ mm	kg		↓ mm 600 x 400 mm	CHF	kg	ΔΔ kg
101.401.000	1000	1805	470	450	13	1 x 225;3 x 150;9 x 75 mm	2'590.-	45	175.8



CHF 249.-



BT700

Art. 101.911.000

BT LINE Servicewagen, leer

MADE IN GERMANY

Ablagefläche mit Gummimatte

Mit zwei Bock- und Lenkrollen

Flächenmass: 40 x 60 cm

Gesamttragkraft: 300 kg



CHF 289.-



BT900

Art. 101.911.001

BT LINE Servicewagen, leer

MADE IN GERMANY

Ablagefläche mit Gummimatte

Mit zwei Bock- und Lenkrollen

Flächenmass: 40 x 80 cm

Gesamttragkraft: 225 kg



Art. 101.911.000	L1	L2	L3	ΔΔ
	719 mm	474 mm	1000 mm	300 kg
L4	650 mm	465 mm	367 mm	100 kg
L5	650 mm	465 mm	367 mm	100 kg

Art. 101.911.001	L1	L2	L3	ΔΔ
	919 mm	474 mm	1000 mm	225 kg
L4	850 mm	465 mm	367 mm	75 kg
L5	850 mm	465 mm	367 mm	75 kg

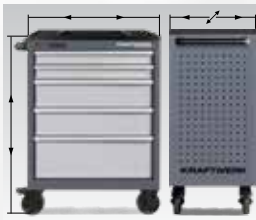

Art. 101.115.100



Art. 101.116.100



Art. 101.117.100



Art. 101.118.100



Art. 101.119.100

Art.	↑ mm	← mm	↘ mm	Kg		↓ mm 600 x 400 mm	CHF	Kg	Δ kg
101.115.100	1000	719	474	450	5	1 x 225;2 x 150;2 x 75 mm	719.-	45	65.28
101.116.100	1000	719	474	450	6	3 x 150;3 x 75 mm	1'055.-	45	66.139
101.117.100	1000	719	474	450	7	2 x 150;5 x 75 mm	799.-	45	71.71
101.118.100	1000	719	474	450	8	1 x 150;7 x 75 mm	849.-	45	73.145
101.119.100	1000	719	474	450	9	9 x 75 mm	1'201.-	45	73.145

LEERE
WERKSTATTWAGEN

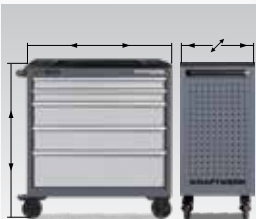

Art. 101.215.100



Art. 101.216.100



Art. 101.217.100



Art. 101.218.100



Art. 101.219.100

Art.	↑ mm	← mm	↘ mm	Kg		↓ mm 800 x 400 mm	CHF	Kg	Δ kg
101.215.100	1000	919	474	450	5	1 x 225;2 x 150;2 x 75 mm	1'148.-	45	76.61
101.216.100	1000	919	474	450	6	3 x 150;3 x 75 mm	1'210.-	45	77.377
101.217.100	1000	919	474	450	7	2 x 150;5 x 75 mm	999.-	45	78.15
101.218.100	1000	919	474	450	8	1 x 150;7 x 75 mm	1'366.-	45	78.932
101.219.100	1000	919	474	450	9	9 x 75 mm	1'428.-	45	79.72

LEERE
WERKSTATTWAGEN

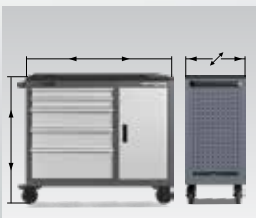

Art. 101.315.100

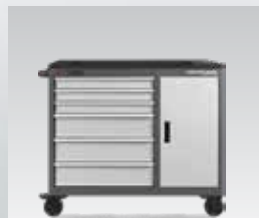

Art. 101.316.100



Art. 101.317.100



Art. 101.318.100



Art. 101.319.100

Art.	↑ mm	← mm	↘ mm	Kg		↓ mm 600 x 400 mm	CHF	Kg	Δ kg
101.315.100	1000	1119	474	450	5	1 x 225;2 x 150;2 x 75 mm	1'459.-	45	79.72
101.316.100	1000	1119	474	450	6	3 x 150;3 x 75 mm	1'521.-	45	83.718
101.317.100	1000	1119	474	450	7	2 x 150;5 x 75 mm	1'499.-	45	83.718
101.318.100	1000	1119	474	450	8	1 x 150;7 x 75 mm	1'677.-	45	85.401
101.319.100	1000	1119	474	450	9	9 x 75 mm	1'590.-	45	86.255



BASIC LINE Werkzeugruhe für BT700/BT900, leer

MADE IN GERMANY

Für alle 60/40 und 80/40 BASIC LINE Werkstattwagen

Sehr stabile doppelwandige Stahlblechkonstruktion

Kugelgelagerte Schubladen

Schubladeneinzelverriegelung über die ganze Leiste

(Einhandbetätigung)

Seitliche Zentralverriegelung aller Schubladen durch Zylinderschloss

Tragfähigkeit pro Schublade: 45 kg

Art. 101.900.002

1369 x --720 x /474 mm | 27.02 kg

	mm	mm	mm
1x	75	600	400
1x	150	600	400

max.
420 kg



CHF **419.-**

**LEERE
WERKZEUGTRUHEN**

Art. 101.900.003

1369 x --720 x /474 mm | 30.06 kg

	mm	mm	mm
3x	75	600	400

max.
420 kg



CHF **479.-**

Art. 101.901.002

1369 x --920 x /474 mm | 32.97 kg

	mm	mm	mm
1x	75	800	400
1x	150	800	400

max.
415 kg



CHF **549.-**

Art. 101.901.003

1369 x --920 x /474 mm | 36.73 kg

	mm	mm	mm
3x	75	800	400

max.
415 kg



CHF **599.-**

⚠ Lieferung ohne Abdeckung



Gelochte Rückwand für alle BASIC LINE Werkstattwagen

MADE IN GERMANY

Zur Aufnahme von zusätzlichen Werkzeugen

Übersichtliche Werkzeuginbringung

Stabile Stahlblechkonstruktion

Inkl. Befestigungsmaterial

Art. 191.509.001

↓ mm	↔ mm	↙ mm	Δ↑ kg
600	719	30	3.5

BT700



CHF 236.-

Art. 191.509.002

↓ mm	↔ mm	↙ mm	Δ↑ kg
800	719	30	4.6

BT700

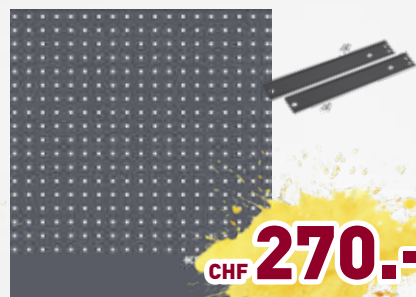

CHF 270.-



Art. 191.509.003

↓ mm	↔ mm	↙ mm	Δ↑ kg
600	919	30	4.0

BT900



CHF 270.-

Art. 191.509.004

↓ mm	↔ mm	↙ mm	Δ↑ kg
800	919	30	5.3

BT900



CHF 299.-



Art. 191.509.005

↓ mm	↔ mm	↙ mm	Δ↑ kg
600	1119	30	4.3

BT1100



CHF 299.-

Art. 191.509.006

↓ mm	↔ mm	↙ mm	Δ↑ kg
800	1119	30	5.7

BT1100

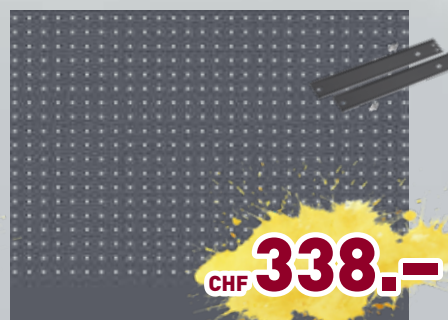

CHF 338.-





PS (Polystyrol) Abdeckung

Leicht zu pflegen
Aus PS (Polystyrol)
Sehr hohe Schlagfestigkeit
Lösemittelbeständig

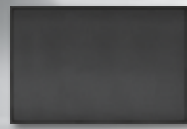

Art.	↓ mm	↔ mm	↗ mm		CHF	Δ kg
143.998.204	30	720	475	LT700	45.-	1.14

Gummimatte

Leicht zu pflegen und abnehmbar
Gummi-Arbeitsfläche sehr strapazierfähig
Rutschhemmende Eigenschaft



Art.	↓ mm	↔ mm	↗ mm		CHF	Δ kg
191.501.001	3	710	465	BT700, LT700	41.-	0.18
191.501.002	3	910	465	BT900	52.-	0.24
191.501.003	3	1110	465	BT1100	56.-	0.29

PS (Polystyrol) Abdeckung

Leicht zu pflegen
Aus PS (Polystyrol)
Sehr hohe Schlagfestigkeit
Lösemittelbeständig
Mit integrierten Ablagefächern



Art.	↓ mm	↔ mm	↗ mm		CHF	Δ kg
143.998.201	28	720	475	BT700, LT700	40.-	1.07
143.998.202	26	920	475	BT900	55.-	1.3
143.998.203	26	1120	475	BT1100	65.-	1.5

Holzplatte

Leicht zu pflegen
Multiplex-Arbeitsfläche aus Buche-Holz
Ideale Arbeitsplatte

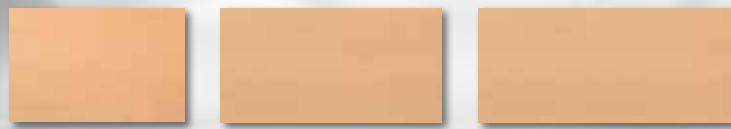

Art.	↓ mm	↔ mm	↗ mm		CHF	Δ kg
191.505.001	25	702	455	BT700, LT700	260.-	7
191.505.002	25	902	455	BT900	283.-	8
191.505.003	25	1102	455	BT1100	319.-	9

Edelstahlabdeckung

Leicht zu pflegen und zu reinigende Oberfläche
Rostfreier Inox Stahl
Als Abdeckhaube für Schichtholz Multiplex Platte

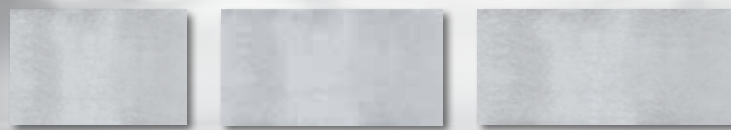

Art.	↓ mm	↔ mm	↗ mm		CHF	Δ kg
191.505.004	30	720	470	BT700, LT700	245.-	3.22
191.505.005	30	920	470	BT900	319.-	4.064
191.505.006	30	1120	470	BT1100	379.-	4.66

Edelstahlabdeckung SET

Bestehend aus Holzplatte und Edelstahlabdeckung

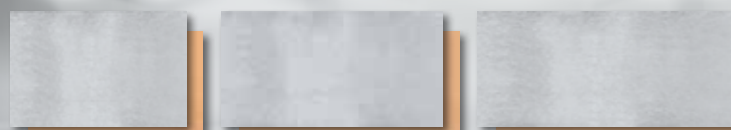

Art.	↓ mm	↔ mm	↗ mm		CHF	Δ kg
191.505.011	30	720	470	BT700, LT700	299.-	10.22
191.505.012	30	920	470	BT900	349.-	12.064
191.505.013	30	1120	470	BT1100	399.-	13.66



Für Serie
BT + PT

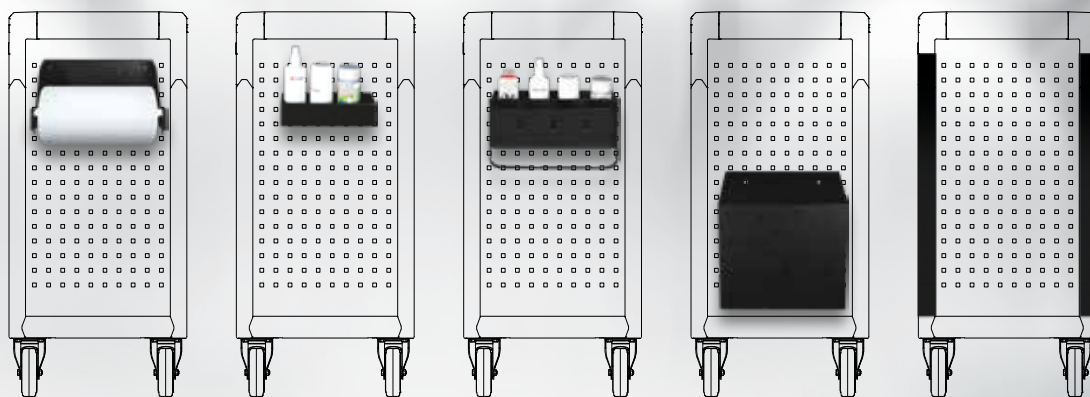

CHF **55.-**

Art. 145.143.010

Papierrollenhalter

Für Papierrollen bis zu Ø 300 mm
Rohrdurchmesser = 20 mm
B 300 x H 150 x T 220 mm, Δ 1,6 kg

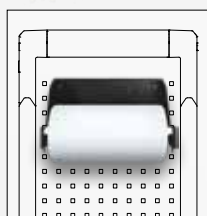

CHF **15.20**

Art. 145.143.011

Ablagefach

Für Dosen und Kleinteile
B 60 x H 215 x T 90 mm, Δ 0,5 kg

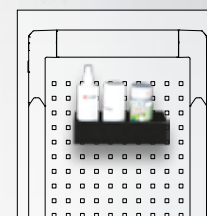

CHF **92.-**

Art. 145.143.012

Ablagefach mit Griff für 8 Dosen

Fachgröße 75 x 80 mm, grosser Griff,
variabel einteilbar
(= Chemiedosenhalter)
B 300 x H 100 x T 160 mm, Δ 2,5 kg

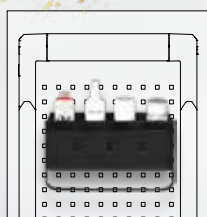

CHF **53.-**

Art. 145.143.013

Papierkorb

B 300 x H 300 x T 160 mm, Δ 3,5 kg

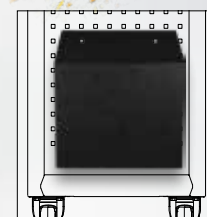

CHF **105.-**

Art. 191.510.004

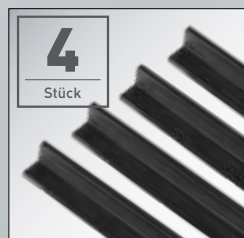

CHF **51.-**

Art. 191.510.001



Kantenschutz

Passend für alle KRAFTWERK Werkstattwagen der **BT Serie**
Verhindert Schäden an Lack und Karosserie
B 710 x H 35 x T 35 mm

Tischwagen

Stahlrohr-Schweisskonstruktion
30 x 30 x 2 mm
Radsatz mit 2 Lenkrollen mit
Radfeststeller, 2 Bockrollen,
Vollgummibereifung 200 x 50 mm
Ladeflächen aus Stahlblech,
Rand 35 mm, verschweisst,
Kanten mit Kantenschutzprofil
Wannenmass:
ausser 1200 x 600 mm
innen 1021 x 596 mm



CHF 589.-



CHF 629.-

Artikel Nr.	143.810.001
Beschreibung	Tischwagen
Ladeflächen aus Stahlblech	2
Traglast pro Wanne gleichmässig verteilt	70 kg
Abmessungen / Gewicht	H 810 x B 1240 x T 600 mm (inkl. Griff) / 45 kg

Artikel Nr.	143.810.002
Beschreibung	Tischwagen
Ladeflächen aus Stahlblech	3
Traglast pro Wanne gleichmässig verteilt	70 kg
Abmessungen / Gewicht	H 810 x B 1240 x T 600 mm (inkl. Griff) / 51 kg

Werkstattwagen

Stahlrohr-Schweisskonstruktion
30 x 30 x 2 mm
Öldicht verschweisst
Kanten mit Kantenschutzprofil
Radsatz, mit 2 Lenkrollen mit
Radfeststeller, 2 Bockrollen,
Vollgummibereifung 200 x 50 mm
Wannenmass:
ausser 1200 x 600 mm
innen 1021 x 596 mm



CHF 739.-



CHF 1'149.-

Artikel Nr.	143.835.001
Beschreibung	Rollwerkbank
Schrankelement oder Schubladenbox	1 Schrankelement
Schubladeneigenschaft	-
Arbeitsplatte	Buchen-Schichtholz Multiplex / 1200 x 600 x 25 mm
Ablageboden	2 x Buchen-Schichtholz Multiplex
Zentralverschiebbare Schubladenbox	✓ / H 470 x B 511 x T 600 mm
Traglast gleichmässig verteilt	500 kg
Abmessungen / Gewicht	H 835 x B 1300 x T 605 mm (inkl. Griff) / 75 kg

Artikel Nr.	143.835.002
Beschreibung	Rollwerkbank
Schubladenbox	1 Schubladenbox mit 3 Schubladen
Schubladeneigenschaft	rollengelagert, Traglast 30 kg, Einzelverriegelung
Arbeitsplatte	Buchen-Schichtholz Multiplex / 1200 x 600 x 25 mm
Ablageboden	2 x Buchen-Schichtholz Multiplex
Zentralverschiebbare Schubladenbox	✓ / H 470 x B 511 x T 600 mm
Traglast gleichmässig verteilt	500 kg
Abmessungen / Gewicht	H 835 x B 1300 x T 605 mm (inkl. Griff) / 85 kg



CHF 779.-

Artikel Nr.	143.835.004
Beschreibung	Rollwerkbank
Schubladen	2 Schubladen
Schubladeneigenschaften	rollengelagert, Traglast 30 kg, Einzelverriegelung
Schubladeninnenmass	B 435 x T 539 mm
Arbeitsplatte	Buchen-Schichtholz Multiplex / 1200 x 600 x 25 mm
Ablageboden	1 x Buchen-Schichtholz Multiplex
Traglast gleichmässig verteilt	500 kg
Abmessungen / Gewicht	H 835 x B 1300 x T 605 mm (inkl. Griff) / 75 kg





CHF 929.-



CHF 999.-

Artikel Nr.	143.835.005
Beschreibung	Rollwerkbank
Schränkelement oder Schubladenbox	1 Schränkelement + 1 Schublade
Schubladeneigenschaft	rollengelagert, Traglast 30 kg, Einzelverriegelung
Schubladeninnenmass	B 459 x T 539 mm
Zentralverschliessbare Schubladenbox	✓ / H 470 x B 511 x T 600 mm
Arbeitsplatte	Buchen-Schichtholz Multiplex / 1200 x 600 x 25 mm
Ablageboden	1 x Buchen-Schichtholz Multiplex
Traglast gleichmässig verteilt	500 kg
Abmessungen / Gewicht	H 835 x B 1300 x T 605 mm (inkl. Griff) / 83 kg

Artikel Nr.	143.835.006
Beschreibung	Rollwerkbank
Schränkelement oder Schubladenbox	2 Schränkelemente
Schubladeneigenschaft	-
Schubladeninnenmass	-
Zentralverschliessbare Schubladenbox	✓ / H 470 x B 511 x T 600 mm
Arbeitsplatte	Buchen-Schichtholz Multiplex / 1200 x 600 x 25 mm
Ablageboden	-
Traglast gleichmässig verteilt	500 kg
Abmessungen / Gewicht	H 835 x B 1300 x T 605 mm (inkl. Griff) / 83 kg



CHF 1'190.-



CHF 1'999.-

Artikel Nr.	143.835.007
Beschreibung	Rollwerkbank
Schränkelement oder Schubladenbox	1 Schubladenbox mit 4 Schubladen
Schubladeneigenschaft	rollengelagert, Traglast 30 kg, Einzelverriegelung
Schubladeninnenmass	B 459 x T 539 mm
Zentralverschliessbare Schubladenbox	✓ / H 470 x B 511 x T 600 mm
Arbeitsplatte	Buchen-Schichtholz Multiplex / 1200 x 600 x 25 mm
Ablageboden	2 x Buchen-Schichtholz Multiplex
Traglast gleichmässig verteilt	500 kg
Abmessungen / Gewicht	H 835 x B 1300 x T 605 mm (inkl. Griff) / 85 kg

Artikel Nr.	143.835.009
Beschreibung	Rollwerkbank
Schränkelement oder Schubladenbox	2 Schubladenboxen mit je 4 Schubladen / 8 Total rollengelagert, Traglast 30 kg, Einzelverriegelung
Schubladeneigenschaft	rollengelagert, Traglast 30 kg, Einzelverriegelung
Schubladeninnenmass	B 459 x T 539 mm
Zentralverschliessbare Schubladenbox	✓ / H 470 x B 511 x T 600 mm
Arbeitsplatte	Buchen-Schichtholz Multiplex / 1200 x 600 x 25 mm
Ablageboden	-
Traglast gleichmässig verteilt	500 kg
Abmessungen / Gewicht	H 835 x B 1300 x T 605 mm (inkl. Griff) / 85 kg



CHF 1'399.-



CHF 1'799.-

Artikel Nr.	143.835.010
Beschreibung	Rollwerkbank
Schränkelement oder Schubladenbox	1 Schubladenbox mit 4 Schubladen + 1 Schränkelement
Schubladeneigenschaft	rollengelagert, Traglast 30 kg, Einzelverriegelung
Schubladeninnenmass	B 459 x T 539 mm
Zentralverschliessbare Schubladenbox	✓ / H 470 x B 511 x T 600 mm
Arbeitsplatte	Buchen-Schichtholz Multiplex / 1200 x 600 x 25 mm
Traglast gleichmässig verteilt	500 kg
Abmessungen / Gewicht	H 835 x B 1300 x T 605 mm (inkl. Griff) / 107 kg

Artikel Nr.	143.835.011
Beschreibung	Rollwerkbank
Schränkelement oder Schubladenbox	4 : H 90 mm / 1 : H 135 mm 1 : H 70 mm + 1 Schränkelement
Schubladeneigenschaft	rollengelagert, Traglast 30 kg, Einzelverriegelung
Schubladeninnenmass	5 x B 460 x T 535 mm 1 x B 995 x T 535 mm
Zentralverschliessbare Schubladenbox	✓ / H 505 x B 490 x T 570 mm
Arbeitsplatte	Buchen-Schichtholz Multiplex / 1200 x 605 x 25 mm
Traglast gleichmässig verteilt	450 kg
Abmessungen / Gewicht	H 925 x B 1200 x T 605 mm (inkl. Griff) / 107 kg

Bügel- und Plattformwagen

Stabile Universalwagen für vielseitigen Einsatz
Ladefläche aus Winkelstahl mit wasserfesten Sperrholzplatten, stabil verschweisst, pulverbeschichtet
Radsatz, 2 Lenk- und 2 Bockrollen, Vollgummibereifung 200 x 50 mm
Einfache Montage



CHF **299.-**



CHF **389.-**



CHF **369.-**



Artikel Nr.	143.270.001	143.270.002	143.270.003
Beschreibung	Plattformwagen	Bügelwagen	Bügelwagen
Griffhöhe	-	950 mm	950 mm
Rungen / Höhe	-	-	2 x H 800 mm / herausnehmbar
Tragfähigkeit pro Radsatz	500 kg	500 kg	500 kg
Abmessungen / Gewicht	H 270 x B 1200 x T 600 mm / 40 kg	H 270 x B 1200 x T 600 mm / 45 kg	H 270 x B 1200 x T 600 mm / 50 kg



CHF **219.-**

Art. 3912

Mehrzweck-Etagen Transportwagen

Stabile Konstruktion für den universellen Gebrauch
Mit 3 grossen Fachböden
Aussenmasse 91 x 48 x 14 mm
Etagenbreite/-tiefe 66 x 39 mm
Tragkraft Etagen max. 8 kg
Tragkraft max. 24 kg
4 Lenkrollen, Ø 1 mm, 2 mit Bremse



CHF **65.55**

Art. 3912-99

Abfallbehälter

Für Mehrzweck-Etagen-Transportwagen Art. 3912
Aus öl- und säureresistentem Polypropylen



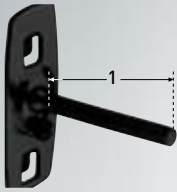

Werkzeughaken
Mit geradem Dorn

Art.	1 mm	Ø mm	ΔΔ g	CHF
145.100.050	50	6	34	4.-
145.100.102	102	6	46	4.50
145.100.150	150	6	56	4.50



Doppelter Werkzeughaken
Mit geradem Dorn

Art.	1 mm	Ø mm	ΔΔ g	CHF
145.110.050	50	6	74	6.-
145.110.102	102	6	98	7.-
145.110.150	150	6	118	6.50



Werkzeughaken
Mit senkrechtem Hakenende

Art.	1 mm	Ø mm	ΔΔ g	CHF
145.111.035	35	6	34	3.70
145.111.070	70	6	46	3.70
145.111.135	135	6	56	4.70

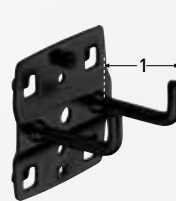

Doppelter Werkzeughaken
Mit senkrechtem Hakenende

Art.	1 mm	Ø mm	ΔΔ g	CHF
145.112.035	35	6	76	6.70
145.112.050	50	6	80	7.-
145.112.075	75	6	90	6.70
145.112.150	150	6	98	9.30

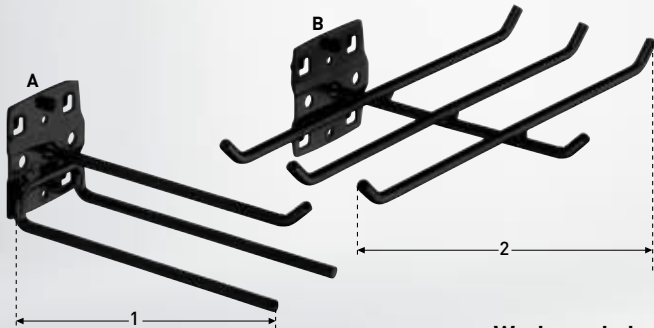

Werkzeughaken

Art.	1 mm	2 mm	Ø mm	ΔΔ g	CHF	
145.113.045	A	45	150	6	170	16.50
145.113.140	B	240	140	6	256	31.-

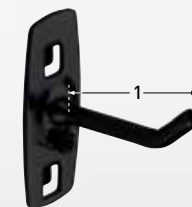

Werkzeughaken
Mit schrägem Hakenende

Art.	1 mm	Ø mm	ΔΔ g	CHF
145.120.050	50	6	34	3.80
145.120.100	100	6	46	4.70
145.120.150	150	6	56	4.70
145.120.200	200	6	68	5.70



Werkzeugklemme, klein

Art.	Ø mm	ΔΔ g	CHF
145.122.006	6	24	5.70
145.122.010	10	25	5.70
145.122.013	13	26	5.70
145.122.016	16	27	5.70
145.122.019	19	28	5.70

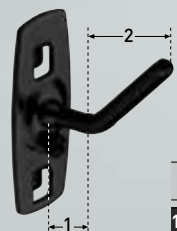

Schräghaken

Art.	1 mm	2 mm	Ø mm	ΔΔ g	CHF
145.121.040	15	35	6	34	4.70



Werkzeugklemme, gross

Art.	1 mm	2 mm	Ø mm	ΔΔ g	CHF
145.123.025	25	25	58	9.70	
145.123.028	28	28	60	9.70	
145.123.032	32	23	64	11.50	

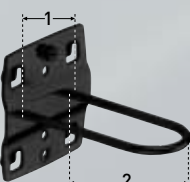

Rundhalter

Art.	1 mm	2 mm	ΔΔ g	CHF
145.124.027	27	65	68	9.50

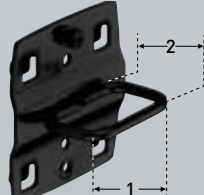

Zangenhalter

Art.	1 mm	2 mm	ΔΔ g	CHF
145.125.035	35	20	62	6.50
145.125.075	75	20	62	8.50



Maschinenhalter

Art.	∅ mm	ΔΔ g	CHF
145.126.060	60	72	17.-
145.126.080	80	80	17.-

Paarweise bestellen



Rohrhalter

Art.	↔ mm	∅ mm	ΔΔ g	CHF
145.127.060	35	60	114	17.-
145.127.100	35	100	156	17.-

Paarweise bestellen

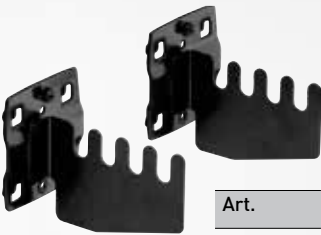

Sägenhalter
Für 4 Sägen

Art.	↓ mm	↗ mm	ΔΔ g	CHF
145.128.080	52	80	85	16.50



Schraubenschlüsselhalter
Für 10 Schraubenschlüssel

Art.	↓ mm	↗ mm	ΔΔ g	CHF
145.129.227	75-145	220	480	31.-



Bithalter
Für 7 Bits

Art.	↔ mm	↗ mm	ΔΔ g	CHF
145.132.150	150	35	200	21.-



Werkzeughalter
Zur individuellen Anpassung

Art.	↔ mm	↓ mm	↗ mm	ΔΔ g	CHF
145.134.340	325	55	135	1100	53.-



Ablageplatte
Für Kleinteile und Werkzeuge

Art.	↔ mm	↗ mm	ΔΔ g	CHF
145.138.350	350	125	600	30.-
145.138.445	445	150	900	43.-



Höhe: ↓ Breite: ↔ Tiefe: ↗

Werkzeughalter für Runddosen

Art.	↔ mm	∅ mm	ΔΔ g	CHF
145.137.001	100	70	200	27.-

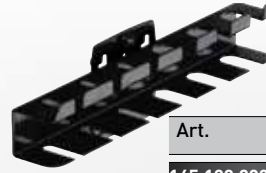

Schraubendreherhalter
Für 6 oder 12 Schraubendreher

Art.	↔ mm	↗ mm	ΔΔ g	CHF
145.129.200	6	200	30	22.-
145.129.390	12	390	30	31.-



Bohrerhalter

Für 14 Bohrer: je 2x ∅ 3.0-4.2-6.5-7.5-8.5-16.5 mm / je 1x ∅ 10.5-12.5 mm
Für 28 Bohrer: je 4x ∅ 3.2-4.2-6.5-7.5-8.5-16.5 mm / je 2x ∅ 10.5-12.5 mm

Art.	↔ mm	↗ mm	ΔΔ g	CHF
145.130.200	200	28	200	21.-
145.130.390	390	28	400	38.-



Winkelstiftschlüsselhalter
Für 9 Winkelstiftschlüssel

Art.	↔ mm	↗ mm	ΔΔ g	CHF
145.131.200	200	73	220	28.-



Steckschlüsselhalter
Für 12 Steckschlüssel

Art.	↔ mm	↗ mm	ΔΔ g	CHF
145.133.390	390	30	500	38.-

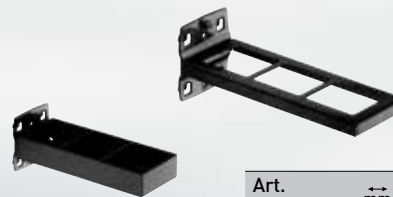

Kombinationshalter
2-teilig

Art.	↔ mm	↗ mm	ΔΔ g	CHF
145.135.150	60	150	400	57.-

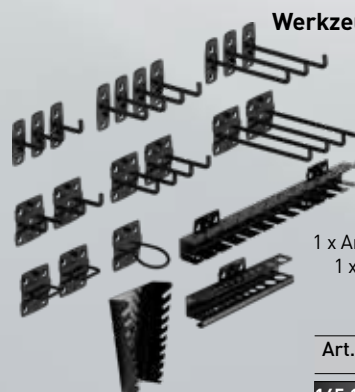

Werkzeughalter- und Hakensortiment, 22-tlg.

- 4 x Art. 145.111.070 L= 70 mm
- 3 x Art. 145.111.135 L=135 mm
- 2 x Art. 145.112.035 L= 35 mm
- 2 x Art. 145.112.075 L= 75 mm
- 2 x Art. 145.112.150 L= 150 mm
- 2 x Art. 145.125.055 W= 55 mm
- 1 x Art. 145.126.060 ∅= 60 mm
- 1 x Art. 145.129.390 für 12 Schraubendreher
- 1 x Art. 145.129.227 für 10 Steckschlüssel
- 1 x Art. 145.130.200 für 14 Bohrer

Art.	ΔΔ g	CHF
145.100.900	2270	65.-



EVA WERKZEUG-EINLAGEN FÜR ALLE KRAFTWERK WERKSTATTWAGEN

Für BT700, BT900, BT1100, BT1800, LT700, PT800 & PT1000



PRO LINE

S

40x20 cm



BASIC LINE

S

40x20 cm



WÄHLEN SIE IHREN WERKSTATTWAGEN NACH IHREN BEDÜRFNISSEN



STELLEN SIE SICH IHRE EIGENE WERKSTATT ZUSAMMEN:



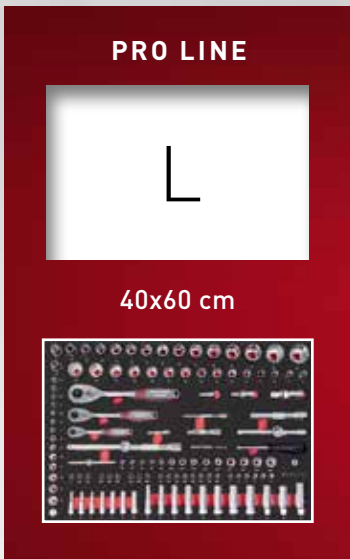

WÄHLEN SIE IHREN WERKSTATTWAGEN NACH IHREN BEDÜRFNISSEN



STELLEN SIE SICH IHRE EIGENE WERKSTATT ZUSAMMEN:

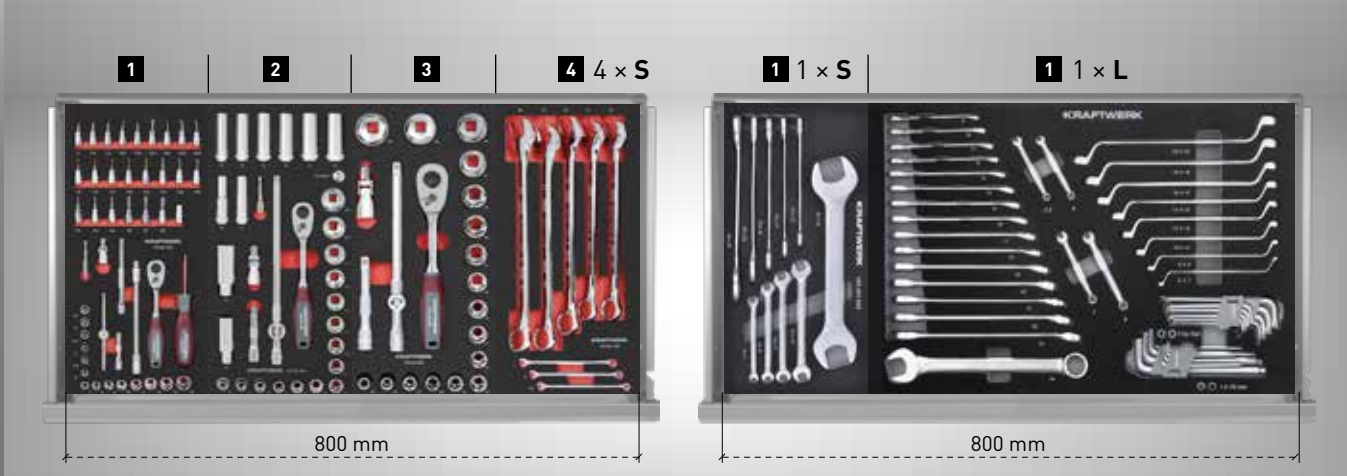

20 × 40 cm



200 × 400 × 40 mm | Δ 1.95 kg

CHF 62.-



Art. 105.301.001

BASIC LINE EVA Schraubendreher-Steckschlüssel-Einlage 3/8", lange Ausführung, 20 × 40 cm, 30-tlg.

3/8" Innensechskant Schraubendreher-Steckschlüsseleinsätze, 90 mm:
3 - 10 mm

3/8" TX Schraubendreher-Steckschlüsseleinsätze, 90 mm: T8 - T50

3/8" Vielzahn Schraubendreher-Steckschlüsseleinsätze, 90 mm: M5 - M12

3/8" RIBE® Schraubendreher-Steckschlüsseleinsätze, 90 mm: M5 - M12

Für Handbetätigung

Chrom-Vanadium / Spitze aus Spezialstahl



200 × 400 × 40 mm | Δ 4.25 kg

CHF 145.-



Art. 105.301.002

BASIC LINE EVA Schlag-Steckschlüssel-Einlage 1/2", lange Ausführung, 20 × 40 cm, 16-tlg.

1/2" Schlag-Steckschlüsseleinsätze, lange Ausführung (6kt.): 13 - 32 mm

1/2" Schlag-Steckschlüsseleinsätze, lange Ausführung (12kt.): 30 + 36 mm

1/2" Schlag-Verlängerung: 125 mm

Für Maschinenbetätigung

Chrom-Molybdän



200 × 400 × 40 mm | Δ 3.76 kg

CHF 95.-



Art. 105.301.003

BASIC LINE EVA Steckschlüssel-Einlage 1/2", 20 × 40 cm, 20-tlg.

1/2" Steckschlüsseleinsätze, lange Ausführung (6kt.): 10 - 32 mm

Für Handbetätigung

Chrom-Vanadium



200 × 400 × 40 mm | Δ 2.5 kg

CHF 75.-



Art. 105.301.004

BASIC LINE EVA Schraubendreher-Steckschlüssel-Einlage 1/2", 20 × 40 cm, 21-tlg.

1/2" Innensechskant Schraubendreher-Steckschlüsseleinsätze, 100 mm:
6 - 17 mm

1/2" Vielzahn Schraubendreher Steckschlüsseleinsätze, 100 mm: M5 - M16

1/2" RIBE® Schraubendreher-Steckschlüsseleinsätze, 100 mm: M8 - M14

Für Handbetätigung

Chrom-Vanadium / Spitze aus Spezialstahl

20 x 40 cm



200 x 400 x 40 mm | Δ 2.87 kg

CHF 95.-

1/2" CrV

Art. 105.301.005

BASIC LINE EVA Steckschlüssel-Einlage 1/2", 20 x 40 cm, 23-tlg.

1/2" Umschaltknarre
 1/2" Verlängerungen: 150 + 200 mm
 1/2" Steckschlüsseleinsätze (6kt.): 8 - 32 mm
 1/2" Kardangelenk und Adapter
 Für Handbetätigung
 Mit Kreuzrändelung
 Chrom-Vanadium

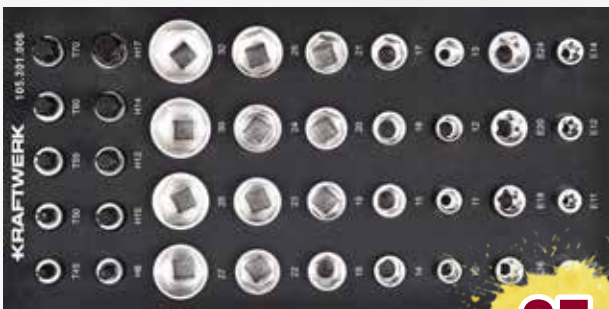

200 x 400 x 40 mm | Δ 3.22 kg

CHF 95.-

1/2" CrV

Art. 105.301.006

BASIC LINE EVA Steckschlüssel-Einlage 1/2", 20 x 40 cm, 38-tlg.

1/2" Steckschlüsseleinsätze (6kt.): 10 - 32 mm
 1/2" Innensechskant-Schraubendreher-Steckschlüsseleinsätze: 8 - 17 mm
 1/2" Aussen-TX-Steckschlüsseleinsätze: E10 - E24
 1/2" TX-Schraubendreher-Steckschlüsseleinsätze: T45 - T70
 Für Handbetätigung
 Chrom-Vanadium / Spitze aus Spezialstahl

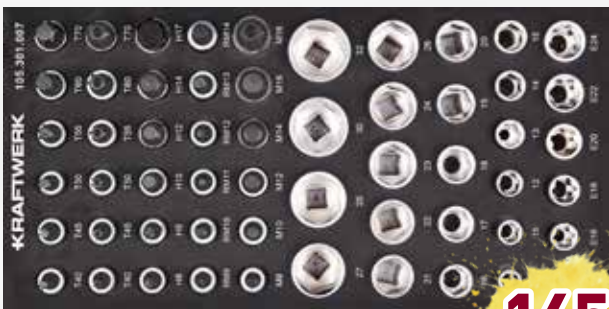

200 x 400 x 40 mm | Δ 4.99 kg

CHF 145.-

1/2" CrV

Art. 105.301.007

BASIC LINE EVA Steckschlüssel-Einlage 1/2", 20 x 40 cm, 56-tlg.

1/2" Steckschlüsseleinsätze (6kt.): 10 - 32 mm
 1/2" Innensechskant-Schraubendreher-Steckschlüsseleinsätze: 8 - 17 mm
 1/2" Aussen-TX-Steckschlüsseleinsätze: E14 - E24
 1/2" TX-Schraubendreher Steckschlüsseleinsätze: T40 - T70
 1/2" TX-TR Schraubendreher Steckschlüsseleinsätze, mit Bohrung: TR40 - TR70
 1/2" Vielzahn-Schraubendreher-Steckschlüsseleinsätze: M9 - M16
 1/2" RIBE®-Schraubendreher-Steckschlüsseleinsätze: M9 - M14
 Für Handbetätigung
 Chrom-Vanadium / Spitze aus Spezialstahl



200 x 400 x 40 mm | Δ 0.18 kg

CHF 14.-

Art. 105.301.008

BASIC LINE EVA Leere-Einlage, 20 x 40 cm

Geeignet für Kleinteile und Werkzeuge
 2 Fächer à 170 x 130 mm



20 × 40 cm



200 × 400 × 40 mm | Δ 2.5 kg

CHF **85.-**

Art. 105.301.009

BASIC LINE EVA Hammer-Einlage, 20 × 40 cm, 3-tlg.

Schlosserhammer: 300 g
Kunststoffhammer: 300 g
Fäustel: 1000 g

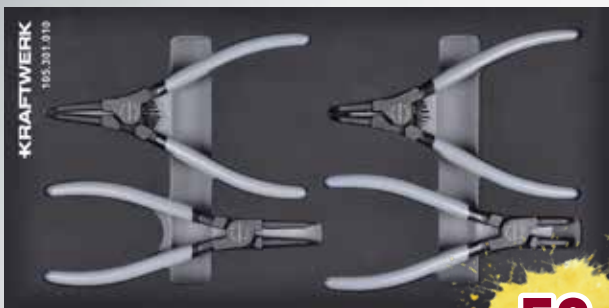

200 × 400 × 40 mm | Δ 1.65 kg

CHF **52.-**

Art. 105.301.010

BASIC LINE EVA Sicherungsring-Zangen-Einlage, 20 × 40 cm, 4-tlg.

Gerade Seegerringzange für Aussenringe: A2 (DIN ISO 5254 A)
Abgewinkelte Seegerringzange für Aussenringe: A21 (DIN ISO 5254B)
Gerade Seegerringzange für Innenringe: J2 (DIN ISO 5256C)
Abgewinkelte Seegerringzange für Innenringe: J21 (DIN ISO 5256D)
Für Sicherungsringe von \varnothing 19-60 mm
Gehärtete Spitzen

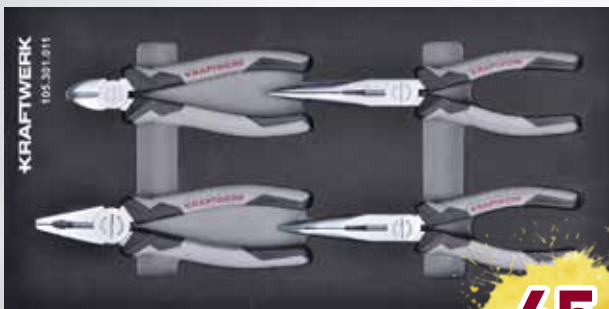

200 × 400 × 40 mm | Δ 2.2 kg

CHF **65.-**

Art. 105.301.011

BASIC LINE EVA Zangen-Einlage, 20 × 40 cm, 4-tlg.

Seitenschneider: 160 mm / 6.1/2"
Flachrundzange, gebogen: 200 mm / 8"
Flachrundzange: 200 mm / 8"
Kombizange: 180 mm / 7"



200 × 400 × 40 mm | Δ 2 kg

CHF **75.-**

Art. 105.301.012

BASIC LINE EVA Doppelringschlüssel-Einlage, 20 × 40 cm, 4-tlg.

Doppelringschlüssel: 21 × 23 - 30 × 32 mm
Beidseitig gekröpft 70°
DIN 838, ISO 3318, ISO 1085, ISO 10104
Chrom-Vanadium



20 x 40 cm



200 x 400 x 40 mm | Δ 0.74 kg

CHF **55.-**



Art. 105.301.013

BASIC LINE EVA Schlag-Schraubendreher-Einlage, 20 x 40 cm, 5-tlg.

Schlitz Schlag-Schraubendreher: 5.5 - 8 mm
PH Schlag-Schraubendreher: PH1 - PH2
Ergonomischer 2-Komponentengriff



200 x 400 x 40 mm | Δ 0.7 kg

CHF **85.-**

Art. 105.301.014

BASIC LINE EVA Feilen-Einlage, 20 x 40 cm, 6-tlg.

Stahldrahtbürste
Edelstahl-Lineal: 300 mm
Schieblehre
Dreieckfeile: 200 mm / 8"
Rundfeile: 200 mm / 8"
Bremsattel-feile: 150 mm / 6"



200 x 400 x 40 mm | Δ 0.72 kg

CHF **45.-**

Art. 105.301.015

BASIC LINE EVA Hakenwerkzeug-Einlage, 20 x 40 cm, 6-tlg.

Hakenwerkzeug, gerade
Hakenwerkzeug, 45° gebogene Spitze
Hakenwerkzeug, 90° gebogene Spitze
Hakenwerkzeug, Sichelform
Rundhaken
Ergonomischer 2-Komponentengriff
Zum Entfernen von Dichtungen, O-Ringen, Zierleistenclips oder Verkleidung
Für Arbeiten an Karosserie-Innenverkleidungen



200 x 400 x 40 mm | Δ 0.68 kg

CHF **45.-**

Art. 105.301.016

BASIC LINE EVA Schraubendreher-Einlage, extra lange Ausführung, 20 x 40 cm, 6-tlg.

Schlitz-Schraubendreher, 250 mm: 4.0 + 5.5 mm
PH-Schraubendreher, 250 mm: PH2
Innensechskant-Schraubendreher, 250 mm: 3 - 6 mm
Ergonomischer 2-Komponentengriff
Mit brüniertes Spitze
Mit Aufhängeloch



20 × 40 cm



200 × 400 × 40 mm | Δ 0.68 kg

CHF **43.-**



Art. 105.301.017

BASIC LINE EVA Schraubendreher-Einlage, extra lange Ausführung, 20 × 40 cm, 6-tlg.

Schlitz-Schraubendreher, 250 mm: 4.0 - 6.5 mm
Innensechskant Schraubendreher, 250 mm: 3 - 5 mm
Ergonomischer 2-Komponentengriff
Mit brüniertes Spitze
Mit Aufhängeloch



200 × 400 × 40 mm | Δ 0.7 kg

CHF **47.-**



Art. 105.301.018

BASIC LINE EVA Schraubendreher-Einlage, extra lange Ausführung, 20 × 40 cm, 6-tlg.

TX Schraubendreher, 250 mm: T15 - T40
Ergonomischer 2-Komponentengriff
Mit brüniertes Spitze
Mit Aufhängeloch

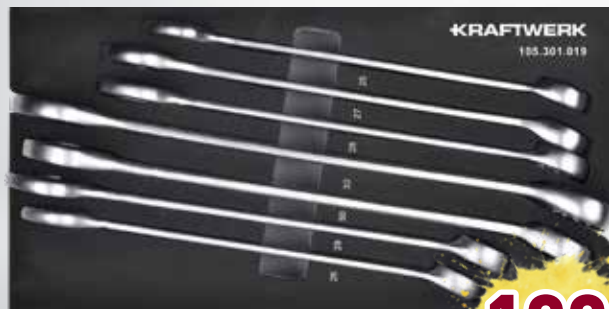

200 × 400 × 40 mm | Δ 3.55 kg

CHF **122.-**



Art. 105.301.019

BASIC LINE EVA Ring-Maulschlüssel-Einlage, 20 × 40 cm, 7-tlg.

Ring-Maulschlüssel: 25 - 32 mm
Ringseite 15° abgewinkelt
DIN 3113 Form A, ISO 3318, ISO 7738
Chrom-Vanadium



200 × 400 × 40 mm | Δ 0.67 kg

CHF **42.-**



Art. 105.301.021

BASIC LINE EVA Winkelschraubendreher-Einlage, 20 × 40 cm, 6-tlg.

Innensechskant Kugelkopf-Winkelschraubendreher: 2.5 - 8 mm
Ergonomischer 2-Komponentengriff

20 × 40 cm



200 × 400 × 40 mm | Δ 0.53 kg

CHF **39.-**

Art. 105.301.022

BASIC LINE EVA TX-Winkelschraubendreher-Einlage, 20 × 40 cm, 6-tlg.

TX-Winkelschraubendreher: T10 - T40
Ergonomischer 2-Komponentengriff



200 × 400 × 40 mm | Δ 1.08 kg

CHF **65.-**

Art. 105.301.023

BASIC LINE EVA Clip- und Lösewerkzeug-Einlage, 20 × 40 cm, 8-tlg.

Türverkleidungs-Lösehebel: 100 mm
Türverkleidungs-Lösehebel: 110 mm
Türverkleidungs-Lösehebel: 132 mm
Hakenwerkzeug, 90° gebogene Spitze
Hakenwerkzeug, Sichelform
Schaber
5/16" Clip Entferner: 115 mm
1/4" Clip Entferner: 115 mm

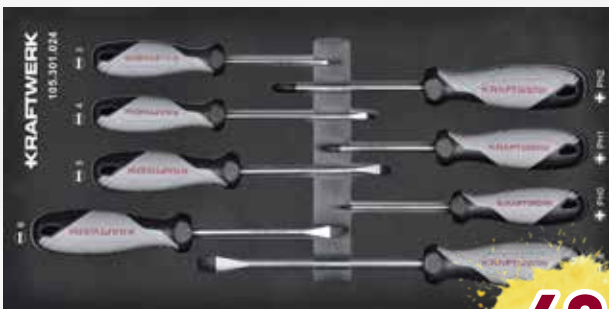

200 × 400 × 40 mm | Δ 0.68 kg

CHF **42.-**

Art. 105.301.024

BASIC LINE EVA Schraubendreher-Einlage, 20 × 40 cm, 8-tlg.

Schlitz Schraubendreher: 3.0 - 8.0 mm
PH Schraubendreher: PH0 - PH2
Ergonomischer 2-Komponentengriff
Mit brüniertes Spitze
Mit Aufhängeloch

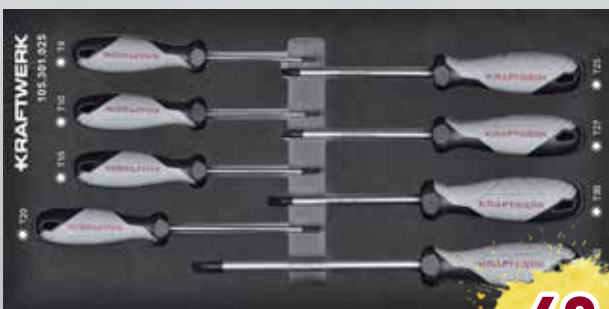

200 × 400 × 40 mm | Δ 0.7 kg

CHF **42.-**

Art. 105.301.025

BASIC LINE EVA TX Schraubendreher-Einlage, 20 × 40 cm, 8-tlg.

TX Schraubendreher: TX T8 - T40
Ergonomischer 2-Komponentengriff
Mit brüniertes Spitze
Mit Aufhängeloch





200 × 400 × 40 mm | Δ 2.85 kg

CHF 93.-



Art. 105.301.026

BASIC LINE EVA Zangen-Einlage, 20 × 40 cm, 8-tlg.

Abgewinkelte Seegerringzange für Aussenringe: A21 (DIN ISO 5254B)

Gerade Seegerringzange für Innenringe: J2 (DIN ISO 5256C)

Seitenschneider: 160 mm / 6.1/2"

Flachrundzange, gebogen: 200 mm / 8"

Flachrundzange: 200 mm / 8"

Kombizange: 180 mm / 7"



200 × 400 × 40 mm | Δ 0.86 kg

CHF 95.-



Art. 105.301.027

BASIC LINE EVA Innensechskant T-Griff-Einlage, 20 × 40 cm, 9-tlg.

Innensechskant T-Griff: 2 - 8 mm

Extra lange Ausführung

Chrom-Vanadium



200 × 400 × 40 mm | Δ 0.86 kg

CHF 99.-



Art. 105.301.028

BASIC LINE EVA TX T-Griff-Einlage, 20 × 40 cm, 9-tlg.

TX T-Griff: T10 - T50

Extra lange Ausführung

Chrom-Vanadium



200 × 400 × 40 mm | Δ 1.75 kg

CHF 69.-



Art. 105.301.029

BASIC LINE EVA Doppel-Maulschlüssel-Einlage, 20 × 40 cm, 10-tlg.

Doppel-Maulschlüssel: 6 - 32 mm

15° Maulstellung

DIN 3110 Form A, ISO 3318, ISO 7738

Chrom-Vanadium

20 × 40 cm

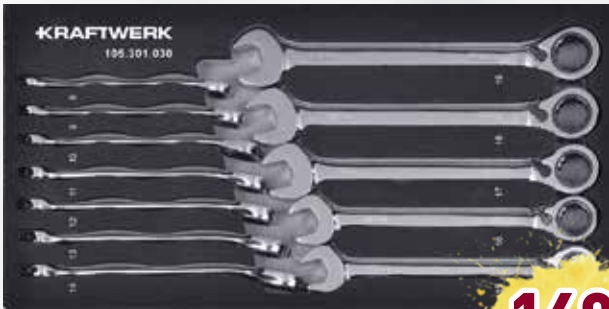

200 × 400 × 40 mm | Δ 1.63 kg



CHF 140.-

Art. 105.301.030

BASIC LINE EVA Ratschen-Ring-Maulschlüssel-Einlage, 20 × 40 cm, 12-tlg.

Ratschen-Ring-Maulschlüssel: 8 - 19 mm
 Hochwertiger 72 Zahn Ratschen-Mechanismus
 15° Maulstellung
 Umschalthebel für Rechts- und Linkslauf
 5° Rückstellwinkel
 Chrom-Vanadium



200 × 400 × 40 mm | Δ 1.69 kg



CHF 140.-

Art. 105.301.031

BASIC LINE EVA Gelenk-Ratschen-Ring-Maulschlüssel-Einlage, 40 × 20 cm, 12-tlg.

Gelenk-Ratschen-Ring-Maulschlüssel: 8 - 19 mm
 180° Kippbarer Ratschen-Kopf
 Gelenkspannung mit Schraube einstellbar
 72 Zahn Ratschensystem
 5° Rückstellwinkel
 Ringseite mit Gelenk
 Chrom-Vanadium



200 × 400 × 40 mm | Δ 2.33 kg



CHF 130.-

Art. 105.301.032

BASIC LINE EVA Ring-Maulschlüssel-Einlage, 20 × 40 cm, 19-tlg.

Ring-Maulschlüssel: 6 - 24 mm
 Ringseite 15° abgewinkelt
 15° Maulstellung
 DIN 3113 Form A, ISO 3318, ISO 7738
 Chrom-Vanadium

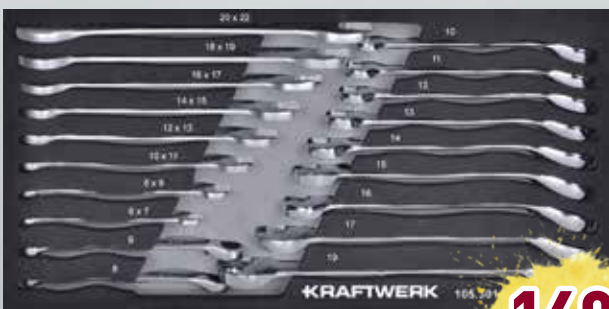

200 × 400 × 40 mm | Δ 2.19 kg

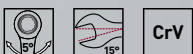

CHF 140.-

Art. 105.301.033

BASIC LINE EVA Ratschen-Ring-Maulschlüssel-Einlage, 20 × 40 cm, 19-tlg.

Ratschen-Ring-Maulschlüssel: 8 - 19 mm
 Doppel-Maulschlüssel: 6 - 22 mm
 Chrom-Vanadium

20 × 40 cm



200 × 400 × 40 mm | Δ 1.89 kg

CHF 115.-



Art. 105.301.034

BASIC LINE EVA Steckschlüssel-Einlage 1/4" + 1/2", 20 × 40 cm, 40-tlg.

- 1/4" + 1/2" Umschaltknarren
- 1/4" + 1/2" Kardangelenke
- 1/4" Verlängerungen: 50 + 100 mm
- 1/4" Steckschlüsseleinsätze: 4 - 13 mm
- 1/2" Verlängerungen: 150 + 200 mm
- 1/2" Steckschlüsseleinsätze: 10 - 32 mm
- Für Handbetätigung
- Chrom-Vanadium

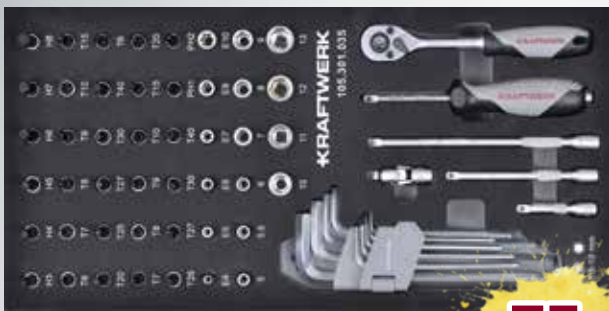

200 × 400 × 40 mm | Δ 1.48 kg

CHF 75.-



Art. 105.301.035

BASIC LINE EVA Steckschlüssel-Einlage 1/4", 20 × 40 cm, 61-tlg.

- 1/4" Umschaltknarre
- 1/4" Verlängerungen: 50, 100, 150 mm
- 1/4" Steckschlüsseleinsätze, lang: 5 - 13 mm
- 1/4" Außen-TX Steckschlüsseleinsätze: E4 - E10
- 1/4" Innensechskant Schraubendreher-Steckschlüsseleinsätze: 3 - 8 mm
- 1/4" TX Schraubendreher-Steckschlüsseleinsätze: TX T6 - T40
- 1/4" TX-TR Schraubendreher-Steckschlüsseleinsätze mit Bohrung: TR6 - TR40
- 1/4" PH Schraubendreher-Steckschlüsseleinsätze: PH1 - PH2
- Winkelstiftschlüsselsatz Sechskant 1.5-10 mm
- 1/4" Kardangelenke
- Für Handbetätigung
- Chrom-Vanadium



200 × 400 × 40 mm | Δ 2.3 kg

CHF 85.-



Art. 105.301.036

BASIC LINE EVA Steckschlüssel-Einlage 3/8", 20 × 40 cm, 40-tlg.

- 3/8" Umschaltknarre
- 3/8" Verlängerungen: 44, 75, 150 mm
- 3/8" Steckschlüsseleinsätze: 8 - 19 mm
- 3/8" Aussen-TX Steckschlüsseleinsätze: E7 - E14
- 3/8" Innensechskant Schraubendreher-Steckschlüsseleinsätze: 6 - 12 mm
- 3/8" TX Schraubendreher-Steckschlüsseleinsätze: T25 - T50
- 3/8" Zündkerzen-Steckschlüsseleinsätze: 14 - 21 mm
- 3/8" Kardangelenke
- Für Handbetätigung
- Chrom-Vanadium



60 × 40 cm



600 × 400 × 40 mm | Δ 6.115 kg

**CHF 225.-****Art. 105.102.011****BASIC LINE EVA Steckschlüssel-Einlage 1/4" + 3/8" + 1/2", 60 × 40 cm, 86-tlg.**

1/4" + 3/8" + 1/2" Umschaltknarren
 1/4" + 3/8" + 1/2" Kardangelenke
 1/4" Steckschlüsseleinsätze: 4 - 14 mm
 1/4" Steckschlüsseleinsätze, lange Ausführung: 4 - 10 mm
 1/4" Verlängerungen: 50 + 100 mm
 1/4" Schraubendreher-Bits
 3/8" Steckschlüsseleinsätze: 10 - 24 mm
 3/8" Steckschlüsseleinsätze, lange Ausführung: 10 - 19 mm
 3/8" Verlängerungen: 75 + 150 mm
 3/8" Zündkerzen-Steckschlüsseleinsätze: 16 + 21 mm
 1/2" Steckschlüsseleinsätze: 14 - 32 mm
 1/2" Verlängerungen: 125 + 250 mm
 Verschiedene Adapter
 Taschenlampe
 Für Handbetätigung
 Chrom-Vanadium



600 × 400 × 40 mm | Δ 4.75 kg

**CHF 199.-****Art. 105.102.012****BASIC LINE EVA Ring-Maul- und Doppelringsschlüssel-Einlage, 60 × 40 cm, 46-tlg.**

Ring-Maulschlüssel: 5.5 - 24 mm
 Doppelringsschlüssel, tief gekröpft: 6 × 7 - 20 × 22 mm
 Kugelpf-Innensechskant-Winkelstiftschlüssel-Satz: 1,5 - 10 mm, 9-tlg.
 TX-Winkelstiftschlüssel-Satz: T10 - T50, 9-tlg.

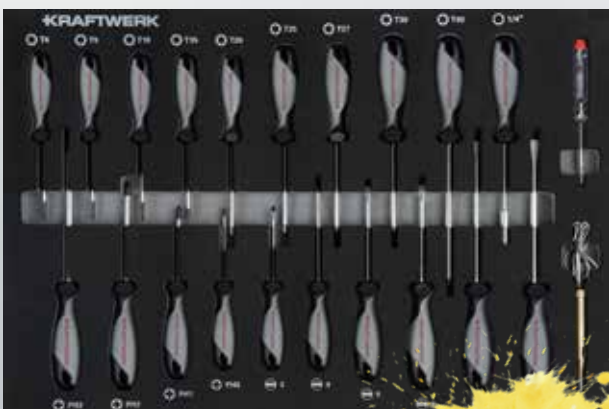

600 × 400 × 40 mm | Δ 2.03 kg

**CHF 95.-****Art. 105.102.013****BASIC LINE EVA Schraubendreher-Einlage, 60 × 40 cm, 22-tlg.**

Schlitz Schraubendreher: 3 - 8 mm
 PH Schraubendreher: PH0 - PH3
 TX Schraubendreher: T8 - T40
 Phasenprüfer 110-250 V, GS-geprüft
 Phasenprüfer 12 V, GS-geprüft
 Schraubendreher mit ergonomischem 2-Komponentengriff

60 × 40 cm

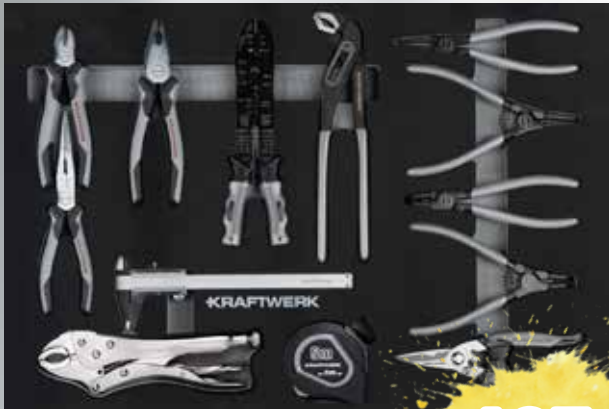

600 × 400 × 40 mm | Δ 3.47 kg



CHF 185.-

Art. 105.102.014

BASIC LINE EVA Zangen- und Messwerkzeug-Einlage, 60 × 40 cm, 13-tlg.

- Abisolier- und Kabelschuhzange, 1,5 - 6 mm²
- Kombizange: 180 mm / 7"
- Seitenschneider: 160 mm / 6.1/2"
- Flachrundzange: 200 mm / 8"
- Wasserpumpenzange: 250 mm / 10"
- Gripzange: 250 mm / 10"
- Seegeringzangen: A2, A21, J2, J21
- Bandmass: 5 m
- Messschieber: 150 mm / 0.05 mm x 1/128"
- Universalschere, 150 mm



600 × 400 × 40 mm | Δ 4.81 kg



CHF 195.-

Art. 105.102.015

BASIC LINE EVA Steckschlüssel-Einlage 1/4" + 3/8" + 1/2", 60 × 40 cm, 107-tlg.

- 5/16" Schlitz Schraubendreher-Bits: 8 - 12 mm
 - 5/16" PH Schraubendreher-Bit: PH4
 - 5/16" PZ Schraubendreher-Bit: PZ4
 - 5/16" Vielzahn Schraubendreher-Bits: M5 - M12
 - 5/16" TX Schraubendreher-Bits: T45 - T80
 - 5/16" TX-TR Schraubendreher-Bits, mit Bohrung: TR45 - TR70
 - 5/16" Innensechskant-Schraubendreher-Bits: 8 - 14 mm
 - 1/4" Aussen-TX Steckschlüsseleinsätze: E4 - E10
 - 1/4" Schlitz Schraubendreher-Steckschlüsseleinsätze: 4 - 6.5 mm
 - 1/4" PH Schraubendreher-Steckschlüsseleinsätze: PH1 - PH3
 - 1/4" PZ Schraubendreher-Steckschlüsseleinsätze: PZ1 - PZ3
 - 1/4" TX Schraubendreher-Steckschlüsseleinsätze: T8- T40
 - 1/4" Innensechskant Schraubendreher-Steckschlüsseleinsätze: 3 - 8 mm
 - 1/4" TX-TR Schraubendreher-Steckschlüsseleinsätze, mit Bohrung: TR10 - TR40
 - 3/8" Aussen-TX Steckschlüsseleinsätze: E10 - E20
 - 1/2" TX Schraubendreher-Steckschlüsseleinsätze: T30 - T60
 - 1/2" TX Schraubendreher-Steckschlüsseleinsätze, 100 mm: T30 - T55
 - 1/2" Innensechskant Schraubendreher-Steckschlüsseleinsätze: 5 - 10 mm
 - 1/2" Innensechskant Schraubendreher-Steckschlüsseleinsätze, 100 mm: 6 - 12 mm
 - 1/2" Vielzahn Schraubendreher-Steckschlüsseleinsätze: M5 - M12
 - 1/2" Vielzahn Schraubendreher-Steckschlüsseleinsätze, 100 mm: M5 - M10
 - 1/2" Aussen-TX Steckschlüsseleinsätze: E10 - E24
- Für Handbetätigung
Chrom-Vanadium



60 x 40 cm



600 x 400 x 40 mm | Δ 3.59 kg

CHF **135.-**

Art. 105.102.016

BASIC LINE EVA Universal-Werkzeug-Einlage, 60 x 40 cm, 27-tlg.

- Flachmeissel: 18 mm
- Flachmeissel: 22 mm
- Körner Nr. 2: 120 mm
- Splintentreiber: 2 mm x 115 mm - 8 mm x 180 mm
- Metallsägebogen
- Flachstumpffeile
- Halbrundfeile
- Rundfeile
- Dreikantfeile
- Abbrechmesser: 18 mm (mit 5 Ersatzklingen)
- Ersatzklingen-Satz (10 Stk.): 18 mm
- DIN Schlosserhammer: 300 g
- Plastikhammer: \varnothing 35 mm



600 x 400 x 40 mm | Δ 5.375 kg

CHF **195.-**

Art. 105.102.017

BASIC LINE EVA Steckschlüssel-Einlage 1/4" + 1/2", 60 x 40 cm, 164-tlg.

- 1/4" + 1/2" Umschaltknarren
- 1/4" + 1/2" Kardangelenke
- 5/16" Schlitz Schraubendreher-Bits: 10 - 12 mm
- 5/16" TX Schraubendreher-Bits: T45 - T60
- 5/16" TX-TR Schraubendreher-Bit, mit Bohrung: TR45 - TR60
- 1/4" Steckschlüsseleinsätze: 4 - 14 mm
- 1/4" Steckschlüsseleinsätze, lange Ausführung: 6 - 13 mm
- 1/4" Verlängerungen: 50 + 100 mm
- 1/4" Schlitz Schraubendreher-Bits: 4 - 8 mm
- 1/4" PH Schraubendreher-Bits: PH0 - PH4
- 1/4" PZ Schraubendreher-Bits: PZ1 - PZ4
- 1/4" TX Schraubendreher-Bits: T8 - T40
- 1/4" Innensechskant Schraubendreher-Bits: 3 - 8 mm
- 1/4" Vielzahn Schraubendreher-Bits: M5 - M8
- 1/4" Vierkant Schraubendreher-Bits: R1 - R2
- 1/2" Steckschlüsseleinsätze: 10 - 32 mm
- 1/2" Verlängerungen: 125 + 250 mm
- 1/2" Zündkerzen-Steckschlüsseleinsätze: 16 + 21 mm
- Verschiedene Adapter
- Für Handbetätigung
- Chrom-Vanadium
- Vorbereitet für Drehmomentschlüssel 3235



60 × 40 cm



600 × 400 × 40 mm | Δ 2.41 kg



CHF **175.-**

Art. 105.102.018

BASIC LINE EVA Schraubendreher- und Schlagwerkzeug-Einlage, 60 × 40 cm, 49-tlg.

Schraubendreher-Bit-Box, 29-tlg.
Nadelfeilen-Satz, 6tlg.
9 LED-Taschenlampe Alu (exkl. 3 × AAA)
Schlitz Schraubendreher: 3.5 - 8 mm
Stubby Schlitz Schraubendreher: 6.5 mm
PH Schraubendreher: PH1 - PH2
Stubby PH Schraubendreher: PH2
Phasenprüfer 110-250 V, GS-geprüft
Hammer: 300 g
Plastikhammer: Ø 35 mm
Flachstumpfeile



600 × 400 × 40 mm | Δ 3.68 kg

CHF **185.-**

Art. 105.102.019

BASIC LINE EVA Werkzeug-Einlage, 60 × 40 cm, 46-tlg.

Ring-Maulschlüssel: 6 - 22 mm
Metallsägebogen: 300 mm
Messer: 9 mm
Messer: 18 mm
Ersatzklingen-Satz (10 Stk.): 9 mm
Ersatzklingen-Satz (10 Stk.): 18 mm
Splintentreiber: 2 mm x 115 mm - 8 mm x 180 mm
Körner Nr. 2: 120 mm
Flachmeissel: 18 + 22 mm



600 × 400 × 40 mm | Δ 3.3 kg



CHF **99.-**

Art. 105.102.110

BASIC LINE EVA Zangen- und Winkelstiftschlüssel-Einlage, 60 × 40 cm, 78-tlg.

Seegerringzangen: J2, J21, A2, A21
Kabelschuh-Sortiment
Abisolier- und Kabelschuhzange: 1,5 - 6 mm²
Kombizange: 180 mm / 7"
Seitenschneider: 160 mm / 6.1/2"
Flachrundzange: 200 mm / 8"
Wasserpumpenzange: 250 mm / 10"
Universalschere: 185 mm
Kugelpf-Innensechskant-Winkelstiftschlüssel-Satz: 1,5 - 10 mm, 9-tlg.
TX-Winkelstiftschlüssel-Satz: T10 - T50, 9-tlg.

60 x 40 cm

**CHF 999.-**

Art. 105.102.099

BASIC LINE EVA Werkzeug-Zusammenstellung, 301-tlg.

301 hochwertige Werkzeuge in 6 speziell hochverdichtete Weich-Schaumstoff-Einlagen (EVA) 60 x 40 cm

Ring-Maulschlüssel: 5,5 - 24 mm

Doppelringschlüssel, tief gekröpft: 6 - 22 mm

1/4" + 3/8" + 1/2" Umschaltknarren und Verlängerungen

1/4" Steckschlüsseleinsätze (6kt.): 4 - 14 mm

3/8" Steckschlüsseleinsätze (6kt.): 10 - 24 mm

1/2" Steckschlüsseleinsätze (6kt.): 14 - 32 mm

5/16" + 1/4" Schraubendreher-Bits

Schlitz-, PH-, PZ-, Innensechskant-, Vielzahn-, TX- und TX-TR-Schraubendreher-Steckschlüsseleinsätze

Kugelpf-Innensechskant-Winkelstiftschlüssel-Satz: 1,5 - 10 mm, 9-tlg.

TX-Winkelstiftschlüssel-Satz: T10 - T50, 9-tlg.

Zangen-Sortiment

Feilen-Satz

Schraubendreher-Sortiment

Schlag- und Schneidwerkzeug

**CHF 599.-**

Art. 105.103.001

BASIC LINE Werkzeug-Zusammenstellung EVA, 337-tlg.

337 hochwertige Werkzeuge in 4 speziell hochverdichteten Weich-Schaumstoff-Einlagen (EVA) 60 x 40 cm

Ring-Maulschlüssel: 6 - 22 mm

1/4" + 1/2" Umschaltknarren und Verlängerungen

1/4" Steckschlüsseleinsätze (6kt.): 4 - 14 mm

1/2" Steckschlüsseleinsätze (6kt.): 10 - 32 mm

Optional Art. 3235 Drehmomentschlüssel 1/2", 40 - 200 Nm

Kugelpf-Innensechskant-Winkelstiftschlüssel-Satz: 1,5 - 10 mm, 9-tlg.

TX-Winkelstiftschlüssel-Satz: T10 - T50, 9-tlg.

Zangen-Sortiment

Feilen-Satz

Schraubendreher-Sortiment

Schlag- und Schneidwerkzeug

**CHF 499.-**

Art. 105.103.002

BASIC LINE EVA Werkzeug-Zusammenstellung, 154-tlg.

154 Werkzeuge in 3 speziell hochverdichteten Weich-Schaumstoff-Einlagen (EVA) 60 x 40 cm

Ring-Maulschlüssel: 5,5 - 24 mm

1/4" + 3/8" + 1/2" Umschaltknarren und Verlängerungen

1/4" Steckschlüsseleinsätze (6kt.): 4 - 14 mm

3/8" Steckschlüsseleinsätze (6kt.): 10 - 24 mm

1/2" Steckschlüsseleinsätze (6kt.): 14 - 32 mm

Schraubendreher-Sortiment

**CHF 499.-**

Art. 105.103.003

BASIC LINE EVA Werkzeug-Zusammenstellung, 147-tlg.

147 hochwertige Werkzeuge in 3 speziell hochverdichteten Weich-Schaumstoff-Einlagen (EVA) 60 x 40 cm

1/4" + 3/8" + 1/2" Aussen TX Steckschlüsseleinsätze

1/4" + 3/8" + 1/2" Schraubendreher-Steckschlüsseleinsätze

5/16" + 1/4" Schraubendreher-Bits

Zangen-Sortiment

Schlag- und Schneidwerkzeug

Feilen-Satz

20 × 40 cm



200 × 400 × 40 mm | Δ 1.2 kg

CHF **135.-**



Art. 105.401.001

PRO LINE EVA Steckschlüssel-Einlage 1/4", 20 × 40 cm, 46-tlg.

- 1/4" Umschaltknarre
- 1/4" Verlängerungen: 50, 100, 150 mm
- 1/4" Steckschlüsseleinsätze: 3.5 - 14 mm
- 1/4" Schlitz Schraubendreher-Steckschlüsseleinsätze: 4 - 6.5 mm
- 1/4" PH Schraubendreher-Steckschlüsseleinsätze: PH1 - PH3
- 1/4" PZ Schraubendreher-Steckschlüsseleinsätze: PZ1 - PZ3
- 1/4" TX Schraubendreher-Steckschlüsseleinsätze: T8 - T40
- 1/4" Innensechskant Schraubendreher-Steckschlüsseleinsätze: 3 - 8 mm
- 1/4" Bit-Adapter
- 1/4" Kardangelenk
- 1/4" Gleitgriff mit Adapter
- 1/4" Steckgriff
- 1/4" Bithalter
- Für Handbetätigung
- Chrom-Vanadium



200 × 400 × 40 mm | Δ 2.45 kg

CHF **125.-**



Art. 105.401.002

PRO LINE EVA Steckschlüssel-Einlage 3/8", 20 × 40 cm, 32-tlg.

- 3/8" Umschaltknarre
- 3/8" Verlängerungen: 75 + 250 mm
- 3/8" Steckschlüsseleinsätze: 8 - 24 mm
- 3/8" Steckschlüsseleinsätze, lange Ausführung: 10 - 19 mm
- 3/8" Zündkerzen-Steckschlüsseleinsätze: 16 + 21 mm
- 3/8" Kardangelenk
- 1/2" auf 3/8" Gleitgriff-Adapter
- 3/8" auf 1/4" Adapter
- 1/4" auf 3/8" Bithalter
- Für Handbetätigung
- Chrom-Vanadium



200 × 400 × 40 mm | Δ 3.15 kg

CHF **155.-**



Art. 105.401.003

PRO LINE EVA Steckschlüssel-Einlage 1/2", 20 × 40 cm, 22-tlg.

- 1/2" Umschaltknarre
- 1/2" Verlängerungen: 125 + 250 mm
- 1/2" Steckschlüsseleinsätze: 10 - 11 - 12 - 13 - 14 - 15 - 16 - 17 - 18 - 19 - 21 - 22 - 24 - 27 - 30 - 32 - 34 mm
- 1/2" Kardangelenk
- 3/8" auf 1/2" Gleitgriff-Adapter
- Für Handbetätigung
- Chrom-Vanadium

20 x 40 cm



200 mm x 400 mm x 40 mm | Δ 1.2 kg

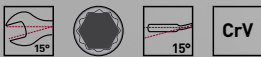

CHF 75.-

Art. 105.401.004

PRO LINE EVA Ring-Maulschlüssel-Einlage, 20 x 40 cm, 12-tlg.

Ring-Maulschlüssel: 8 - 19 mm
 Ringseite 15° abgewinkelt
 15° Maulstellung
 DIN 3113 Form A, ISO 3318, ISO 7738
 Chrom-Vanadium



200 x 400 x 40 mm | Δ 1.6 kg

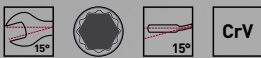

CHF 85.-

Art. 105.401.005

PRO LINE EVA Ring-Maulschlüssel-Einlage, 20 x 40 cm, 8-tlg.

5.5 - 24 mm
 Ringseite 15° abgewinkelt
 15° Maulstellung
 DIN 3113 Form A, ISO 3318, ISO 7738
 Chrom-Vanadium



200 x 400 x 40 mm | Δ 1.5 kg



CHF 85.-

Art. 105.401.006

PRO LINE EVA Doppelringschlüssel-Einlage, 20 x 40 cm, 8-tlg.

Doppelringschlüssel: 6 - 22 mm
 DIN 838, ISO 3318, ISO 1085, ISO 10104
 70° beidseitig abgewinkelt
 Chrom-Vanadium



200 x 400 x 40 mm | Δ 1.97 kg



CHF 135.-

Art. 105.401.034

PRO LINE EVA "S" Doppelmaulschlüssel-Satz, 20x40, 10-tlg.

6 x 7 - 8 x 9 - 1 x 11 - 12 x 13 - 14 x 15 - 16 x 17 - 18 x 19 - 21 x 22 - 24 x 27 -
 30 x 32 mm
 DIN 311, ISO 3318, ISO 185, ISO 112
 Verchromt

20 × 40 cm

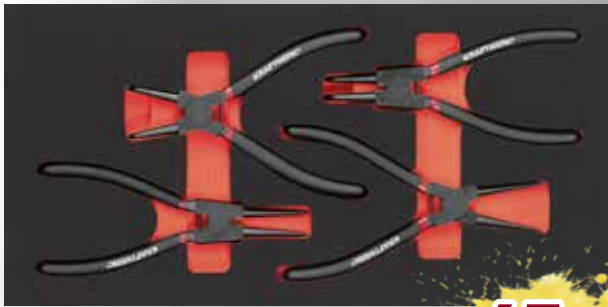

200 × 400 × 40 mm | Δ 0.62 kg

CHF **65.-**



Art. 105.401.007

PRO LINE EVA Sicherungsring-Zangen-Einlage, 20 × 40 cm, 4-tlg.

Gerade Seegerringzange für Aussenringe: A2 (DIN ISO 5254 A)
Abgewinkelte Seegerringzange für Aussenringe: A21 (DIN ISO 5254B)
Gerade Seegerringzange für Innenringe: J2 (DIN ISO 5256C)
Abgewinkelte Seegerringzange für Innenringe: J21 (DIN ISO 5256D)
Für Sicherungsringe von Ø 19-60 mm
Gehärtete Spitzen



200 × 400 × 40 mm | Δ 1.8 kg

CHF **65.-**

Art. 105.401.009

PRO LINE EVA Feilen-Einlage, 20 × 40 cm, 11-tlg.

Flachstumpffeile, 320 mm
Halbrundfeile, 320 mm
Rundfeile, 320 mm
Vierkantfeile, 320 mm
Dreikantfeile, 320 mm
Mit ergonomischen 2-Komponentengriff
Nadelfeile, Flachstumpf - Halbrund - Rund - Vierkant - Dreikant - Messe
Mit getauchtem Griff

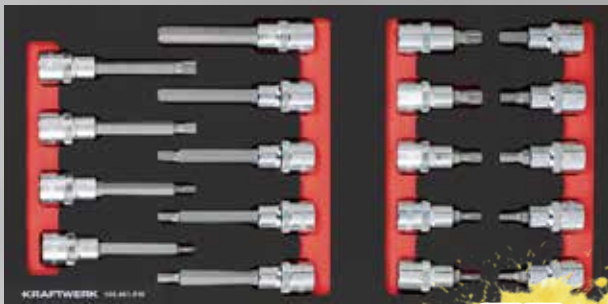

200 × 400 × 45 mm | Δ 1.94 kg

CHF **75.-**



Art. 105.401.010

PRO LINE EVA Steckschlüssel-Einlage 1/2", 20 × 40 cm, 19-tlg.

1/2" Innensechskant Schraubendreher-Steckschlüsseleinsätze, 55 mm: 5 - 10 mm
1/2" Vielzahn Schraubendreher-Steckschlüsseleinsätze, 55 mm: M5 - M12
1/2" Innensechskant Schraubendreher-Steckschlüsseleinsätze, 100 mm: 6 - 12 mm
1/2" Vielzahn Schraubendreher-Steckschlüsseleinsätze, 100 mm: M5 - M10

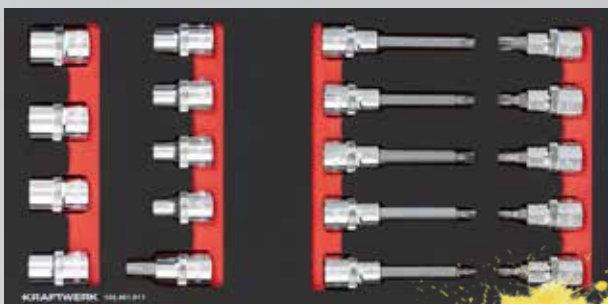

200 × 400 × 45 mm | Δ 1.94 kg

CHF **75.-**



Art. 105.401.011

PRO LINE EVA Steckschlüssel-Einlage 1/2", 20 × 40 cm, 19-tlg.

1/2" Aussen-TX Steckschlüsseleinsätze: E10 - E24
1/2" TX Schraubendreher-Steckschlüsseleinsätze, 55 mm: T30 - T60
1/2" TX Schraubendreher-Steckschlüsseleinsätze, 100 mm: T30 - T55



20 × 40 cm

**NEUES
PRODUKT**



200 × 400 × 45 mm | Δ 1.1 kg



CHF 65.-

Art. 105.401.012

PRO LINE EVA Schlitz/PH Schraubendreher-Einlage, 20 × 40 cm, 8-tlg.

MADE IN GERMANY

PRO LINE Schlitz Schraubendreher: 4 - 8 mm

PRO LINE PH Schraubendreher: PH1 - PH2

Ergonomischer Gelpolster-Griff, der sich an die Hand anpasst

3-Komponenten Griff mit Abrollschutz

Nahtfreie glatte Kappe für minimale Reibung

Querloch am Schraubendreherkopf

Schraubensymbole auf der Griffkappe

Präzisionsspitze garantiert hohe Passgenauigkeit und Langlebigkeit, mit

hochwertigem Magneten ausgestattet

Durchgehender Hartkern am Griff

Klinge aus spezieller Chrom-Vanadium-Legierung

Über DIN/ISO-Vorgaben

Optimale Kraftübertragung



BTG
Back to Germany

**NEUES
PRODUKT**

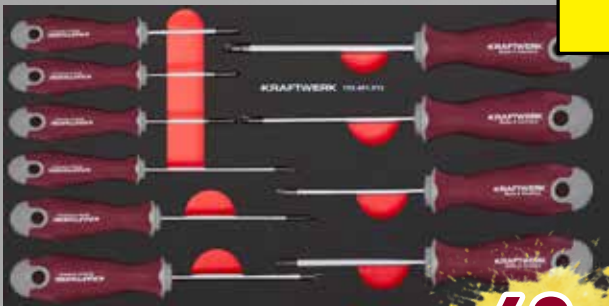

200 × 400 × 45 mm | Δ 1.1 kg



CHF 69.-

Art. 105.401.013

PRO LINE EVA TX Schraubendreher-Einlage, 20 × 40 cm, 10-tlg.

MADE IN GERMANY

PRO LINE TX Schraubendreher TX7 - TX40

Ergonomischer Gelpolster-Griff, der sich an die Hand anpasst

3-Komponenten Griff mit Abrollschutz

Nahtfreie glatte Kappe für minimale Reibung

Querloch am Schraubendreherkopf

Schraubensymbole auf der Griffkappe

Präzisionsspitze garantiert hohe Passgenauigkeit und Langlebigkeit, mit

hochwertigem Magneten ausgestattet

Durchgehender Hartkern am Griff

Klinge aus spezieller Chrom-Vanadium-Legierung

Über DIN/ISO-Vorgaben

Optimale Kraftübertragung



BTG
Back to Germany



20 × 40 cm



200 × 400 × 40 mm | Δ 2.16 kg

CHF **115.-**

Art. 105.401.015

PRO LINE EVA Schlagwerkzeug-Einlage, 20 × 40 cm, 11-tlg.

DIN Schlosserhammer: 500 g
Schonhammer: Ø 35 mm
Flachmeissel: 18 - 22 mm
Splintentreiber: 2 - 8 mm
Körner Nr. 2: 120 mm



200 × 400 × 40 mm | Δ 1.08 kg

CHF **55.-**

Art. 105.401.016

PRO LINE EVA Schneidwerkzeug-Einlage, 20 × 40 cm, 21-tlg.

Messer: 9 mm
Messer: 18 mm
Ersatzklingen-Satz (10 Stk.): 9 mm
Ersatzklingen-Satz (5 Stk.): 18 mm
Metallsägebogen: 300 mm



200 × 400 × 40 mm | Δ 1.5 kg

CHF **145.-**

Art. 105.401.017

PRO LINE EVA HIGHTECH Zangen-Einlage, 20 × 40 cm, 4-tlg.

Kombizange: 180 mm / 7"
Seitenschneider: 160 mm / 6.1/4"
Flachrund-Zange: 205 mm / 8"
Wasserpumpenzange: 240 mm / 9.1/2"



200 × 400 × 40 mm | Δ 1.2 kg

CHF **165.-**

Art. 105.401.018

PRO LINE EVA Ratschen-Ring-Maulschlüssel-Einlage, 20 × 40 cm, 12-tlg.

Ratschen-Ring-Maulschlüssel: 8 - 19 mm
Hochwertiger 72 Zahn Ratschen-Mechanismus
5° Rückstellwinkel
Gerade Ausführung
15° Maulstellung
Chrom-Vanadium

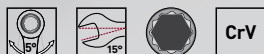

20 × 40 cm

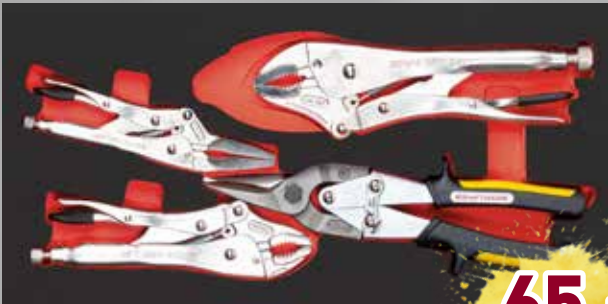

200 × 400 × 40 mm | Δ 1.55 kg

CHF **65.-**

Art. 105.401.023

PRO LINE EVA Zangen-Einlage, 20 × 40 cm, 4-tlg.

Blechscherer: 250 mm / 10"
Gripzange: 175 mm / 7"
Gripzange: 250 mm / 10"
Klemmzange: 150 mm / 6"



200 × 400 × 40 mm | Δ 1.18 kg

CHF **99.-**

Art. 105.401.026

PRO LINE EVA ERGOKRAFT Zangen-Einlage, 20 × 40 cm, 4-tlg.

Kneifzange: 200 mm / 8"
Abisolierzange: 160 mm / 6.1/2"
Abisolier- und Kabelschuhzange: 1,5 - 6 mm²
Universalscherer: 150 mm



200 × 400 × 78 mm | Δ 3.99 kg

CHF **319.-**

Art. 105.401.027

PRO LINE EVA Steckschlüssel-Einlage 1/2", 20 × 40 cm, 17-tlg.

1/2" Schlagschrauber, 920 Nm
1/2" Schlag-Steckschlüsseleinsätze: 10 - 24 mm
1/2" Schlag-Steckschlüsseleinsätze für Alu-Felgen: 17 - 24 mm
1/2" Verlängerung: 125 mm
Chrom Molybdän



200 × 400 × 60 mm | Δ 2.8 kg

CHF **109.-**

Art. 105.401.028

PRO LINE EVA Steckschlüssel-Einlage 1/2", 20 × 40 cm, 20-tlg.

1/2" Schlag-Steckschlüsseleinsätze: 10 - 36 mm
1/2" Schlag-Verlängerung: 125 mm
Für Maschinenbetätigung
Chrom Molybdän



20 × 40 cm



200 × 400 × 67 mm | Δ 4.26 kg



CHF **149.-**

Art. 105.401.029

PRO LINE EVA Steckschlüssel-Einlage 1/2", 20 × 40 cm, 15-tlg.

1/2" Schlag-Steckschlüsseleinsätze, lange Ausführung: 13 - 36 mm

1/2" Schlag-Verlängerung: 125 mm

Für Maschinenbetätigung

Chrom Molybdän



200 × 400 × 40 mm | Δ 0.83 kg



CHF **69.-**

Art. 105.401.031

PRO LINE EVA T-Griff Schraubendreher Innensechskant-Einlage, 20 × 40 cm, 7-tlg.

Sechskant Kugelkopf-T-Griff-Schraubendreher

Schlüsselweite: 3 - 10 mm

Mit ergonomischem 2-Komponenten-Griff



200 × 400 × 40 mm | Δ 3.233 kg



CHF **219.-**

Art. 105.401.032

PRO LINE EVA 1/2" Steckschlüssel-Einlage, 20 × 40 cm, 33-tlg.

Kurze Ausführung 55 mm

Steckschlüsseleinsatz Innensechskant: 5 - 6 - 7 - 8 - 10 - 12 mm

Steckschlüsseleinsatz TX: T30 - T40 - T45 - T50 - T55 - T60

Steckschlüsseleinsatz Vielzahn: M5 - M6 - M8 - M10 - M12 - M14

Lange Ausführung 100 mm

Steckschlüsseleinsatz Innensechskant: 6 - 7 - 8 - 10 - 12 mm

Steckschlüsseleinsatz TX: T30 - T40 - T45 - T50 - T55

Steckschlüsseleinsatz Vielzahn: M5 - M6 - M8 - M10 - M12

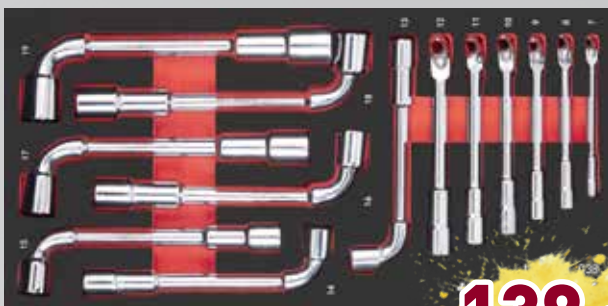

200 × 400 × 40 mm | Δ 2.613 kg



CHF **139.-**

Art. 105.401.038

PRO LINE EVA Pfeifenkopfschlüssel -Einlage, 20 × 40 cm, 13-tlg.

Pfeifenkopfschlüssel, Zwölfkant x Sechskant

7 - 8 - 9 - 10 - 11 - 12 - 13 - 14 - 15 - 16 - 17 - 18 - 19 mm

20 × 40 cm



200 × 400 × 40 mm | Δ 0.18 kg

CHF 18.-

Art. 105.401.039

PRO LINE EVA Kleinteile-Einlage, 20 × 40 cm
8 Fachunterteilungen



200 × 400 × 40 mm | Δ 2.466 kg

CHF 299.-

Art. 105.401.041

PRO LINE EVA Ratschen Ringmaulschlüssel-Einlage, 20 × 40 cm, 14-tlg.

Schlüsselweite: 8 - 9 - 10 - 11 - 12 - 13 - 14 - 15 - 16 - 17 - 18 - 19 - 22 - 24 mm
Umschalthebel für Rechts- und Linkslauf
Hochwertiger 72 Zahn Ratschen-Mechanismus
5° Rückstellwinkel
Gerade Ausführung
15° Maulstellung
Hochglanz verchromt
Chrom-Vanadium



200 × 400 × 40 mm | Δ 0.6 kg

CHF 69.-

Art. 105.401.043

PRO LINE EVA TX T-Griff Schraubendreher-Einlage, 20 × 40 cm, 7-tlg.

Schlüsselweite: T10 - T40
Mit ergonomischem 2-Komponenten-Griff



200 × 400 × 40 mm | Δ 2.8 kg

CHF 169.-

Art. 105.401.045

PRO LINE EVA offene Doppelringschlüssel-Einlage, 20 × 40 cm, 13-tlg.

Ratschenschlüssel mit Gelenk: 8 - 10 - 11 - 12 - 13 - 14 mm
Offene Doppelringschlüssel metrisch: 9 × 11 - 10 × 12 - 13 × 14 - 15 × 17 mm
Offene Doppelringschlüssel INCH: 3/8" × 7/16" - 1/2" × 9/16" - 5/8" × 11/16"



20 × 40 cm



200 × 400 × 40 mm | Δ 1.2 kg

**NEUES
PRODUKT**

CHF 169.-

Art. 105.401.046

PRO LINE EVA Messwerkzeug-Einlage, 20 × 40 cm, 10-tlg.

- Schieblehre 150 mm (auch passend mit digitaler Schieblehre Art. Nr. 2972)
- Stahlmassstab 300 mm
- Fühlerblattelehre 0.05-0.8 mm
- Aussen-Mikrometer 0-25 mm
- Winkelmesser
- Flachwinkel
- Teleskop-Magnetsucher
- Rollmeter 5m
- Doppelmeter Holz

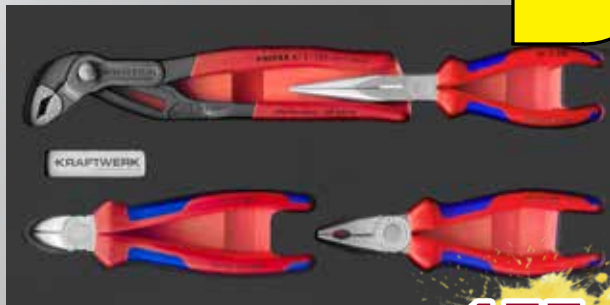

200 × 400 × 40 mm | Δ 0.91 kg

**NEUES
PRODUKT**

CHF 155.-

Art. 105.401.048

KNIPEX EVA Zangen-Einlage, 20x40 cm, 4-tlg.

- Kombizange: 180 mm / 7"
- Seitenschneider: 160 mm / 6.1/4"
- Flachrund-Zange: 200 mm / 8"
- Wasserpumpenzange: 250 mm / 9.1/2"



200 × 400 × 40 mm | Δ 1.73 kg

CHF 89.-

Art. 105.401.051

PRO LINE EVA Winkelstiftschlüssel-Einlage, 20 × 40 cm, 28-tlg.

- Kugelpf-Innensechskantschlüssel, 1.5 - 2 - 2.5 - 3 - 4 - 5 - 6 - 7 - 8 - 10 mm
- Stiftschlüssel, TX T10 - T15 - T20 - T25 - T27 - T30 - T40 - T45 - T50
- Stiftschlüssel, TX-TR T10 - T15 - T20 - T25 - T27 - T30 - T40 - T45 - T50



20 x 40 cm



**NEUES
PRODUKT**

Art. 105.401.020

PRO LINE EVA Schraubendreher-PB-Einlage, 20x40 cm, 16-tlg.

PB Schraubendreher, Schlitz 0.5 x 3.5 mm - 0.6 x 4.0 mm - 0.8 x 5.5 mm - 1.0 x 6.5 mm - 1.2 x 8 mm

PB Schraubendreher, PH1 - PH2

1/4" PB Bitdreher, magnetisch, 10 x 30 mm

1/4" TX-TR Bits:

TR10 - TR15 - TR20 - TR25 - TR27 - TR30 - TR41

Spannungsprüfer, 110-250 V



200 x 400 x 40 mm | Δ 1.1 kg

CHF **128.-**

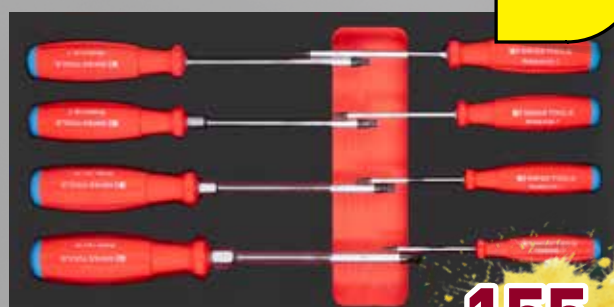

**NEUES
PRODUKT**

Art. 105.401.047

PRO LINE EVA TX-Schraubendreher-PB-Einlage, 20x40, 8-tlg.

PB Schraubendreher TX 8-10-15-20-25-27-30-40



200 x 400 x 40 mm | Δ 0.65 kg

CHF **155.-**



Art.		Δ Kg	CHF
105.998.047	Leere Einlage zu 105.401.047	0.18	29.-

60 × 40 cm

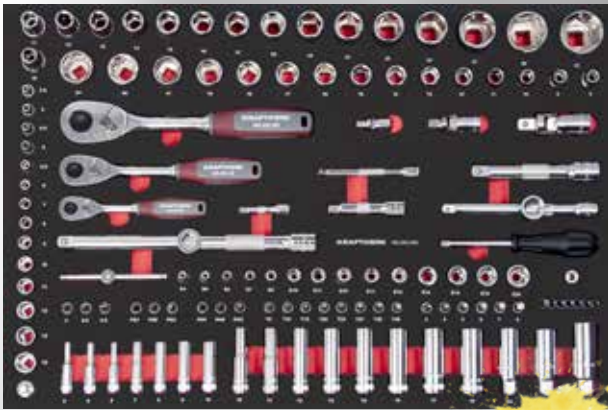

400 × 600 × 40 mm | ΔT 7.2 kg

CHF 399.-



Art. 105.502.026

PRO LINE EVA Steckschlüssel-Einlage 1/4"+3/8"+1/2", 60 × 40 cm, 125-tlg.

- 1/4" Umschaltknarre
- 1/4" Steckschlüsseleinsätze (6kt.): 3.5 - 14 mm
- 1/4" Steckschlüsseleinsätze, lange Ausführung (6kt.): 4 - 10 mm
- 1/4" Schlitz Schraubendreher-Steckschlüsseleinsätze: 4 - 6.5 mm
- 1/4" PH Schraubendreher-Steckschlüsseleinsätze: PH1 - PH3
- 1/4" PZ Schraubendreher-Steckschlüsseleinsätze: PZ1 - PZ3
- 1/4" TX Schraubendreher-Steckschlüsseleinsätze: T8 - T40
- 1/4" TX-TR Schraubendreher-Steckschlüsseleinsätze, mit Bohrung: TR10 - TR40
- 1/4" Innensechskant Schraubendreher-Steckschlüsseleinsätze: 3 - 8 mm
- 1/4" Aussen TX Steckschlüsseleinsätze: E4 - E11
- 1/4" Kardangelen
- 1/4" Verlängerung: 50 - 100 mm
- 1/4" Gleitgriff mit Adapter
- 1/4" Steckgriff
- 1/4" Bit-Adapter
- 3/8" Umschaltknarre
- 3/8" Steckschlüsseleinsätze (6kt.): 8 - 24 mm
- 3/8" Steckschlüsseleinsätze, lange Ausführung (6kt.): 10 - 19 mm
- 3/8" Aussen TX Steckschlüsseleinsätze: E10 - E20
- 3/8" Zündkerzen-Steckschlüsseleinsätze: 16 - 18 - 21 mm
- 3/8" Kardangelen
- 3/8" Verlängerung: 75 - 250 mm
- 3/8" Gleitgriff-Adapter
- 3/8" auf 1/4" Adapter
- 1/2" Steckschlüsseleinsätze (6kt.): 10 - 32 mm
- 1/2" Umschaltknarre
- 1/2" Kardangelen
- 1/2" Verlängerung: 125 - 250 mm
- 1/2" Gleitgriff-Adapter



400 × 600 × 40 mm | ΔT 2.16 kg

CHF 479.-

Art. 105.502.027

PRO LINE EVA Zangen-Einlage, 60 × 40 cm, 11-tlg.

- Zangenschlüssel 250 mm
- Kombizange 180 mm
- Seitenschneider 160 mm
- Hebel Kraftseitenschneider 200 mm
- Radiozange 205 mm
- Radiozange 45° 205 mm
- Sicherungsringzange A2
- Sicherungsringzange A21
- Sicherungsringzange J2
- Sicherungsringzange J21
- Abisolierzange 160 mm



400 × 600 × 40 mm | ΔT 7.04 kg

CHF 479.-



Art. 105.502.028

PRO LINE EVA Schraubenschlüssel-Einlage, 60 × 40 cm, 44-tlg.

- Ring-Maulschlüssel: 5.5 - 32 mm
- Industrie-Rollgabelschlüssel 150 mm / 6"
- Industrie-Rollgabelschlüssel 200 mm / 8"
- Inkl. Art. 3235, Drehmomentschlüssel 1/2", 4 - 200 Nm
- Kugelpf-Innensechskantschlüssel: 1.5 - 1 mm, 9-tlg.
- TX-Winkelstiftschlüssel: T1 - T5, 9-tlg.

Art. 105.503.028

PRO LINE EVA Schraubenschlüssel-Einlage, 60 × 40 cm, 43-tlg.

Exklusive Art. 3235, Drehmomentschlüssel 1/2", 4 - 200 Nm

CHF 329.-

60 x 40 cm

**NEUES
PRODUKT**



CHF **590.-**

400 x 600 x 40 mm | Δ 18,5 kg

Art. 105.502.029

PRO LINE EVA Karosserie-Spezial-Werkzeugschale, 60x40 cm, 16-tlg.

Handfaust: Keilform - Kommaform - Zehenform
Spann- und Schlichthammer
Schlicht- und Treibhammer
Ausbeul- und Planierhammer, geriffelt
Ausbeul- und Planierhammer, gerade
Ausbeul- und Planierhammer, gewölbt
Karosseriefeilen-Spannhalter: 35 mm
Karosserie-Feilenblatt, 9" - 12" - 15"
Karosserie-Löffeleisen
Karosserie-Meißel
Mini-Druckluft-Ausblaspistole
Abbrechmesser

**NEUES
PRODUKT**



CHF **439.-**

400 x 600 x 40 mm | Δ 15 kg

Art. 105.502.030

PRO LINE EVA Steckschlüssel-Einlage 3/4", 60x40 cm, 21-tlg.

3/4" Umschaltknarre mit Teleskopgriff, 500 - 800 mm, 42 Zahn
3/4" Steckschlüsseleinsatz (6 kt.): 19 - 50 mm
Optional mit Digital-Drehmomentadapter 100-500 Nm (Art. 4081-34)
Optional mit Digital-Drehmomentadapter 200-1000 Nm (Art. 4081-341)

3/4"

**NEUES
PRODUKT**



CHF **649.-**

400 x 600 x 40 mm | Δ 2.23 kg

Art. 105.502.031

PRO LINE EVA KNIPEX Zangen-Einlage, 60x40 cm, 12-tlg.

Seitenschneider 180 mm
Kombizange 180 mm
Flachrundzange 200 mm
Flachrundzange 45° 200mm
Abisolierzange 160 mm
Sicherungsringzange Innen
Sicherungsringzange für Innenringe 90°
Sicherungsringzange Aussen
Sicherungsringzange Aussen 90°
Kneifzange 180 mm
Crimpzange 180 mm
Wasserpumpenzange 250 mm





WERKSTATTWAGEN

PT800

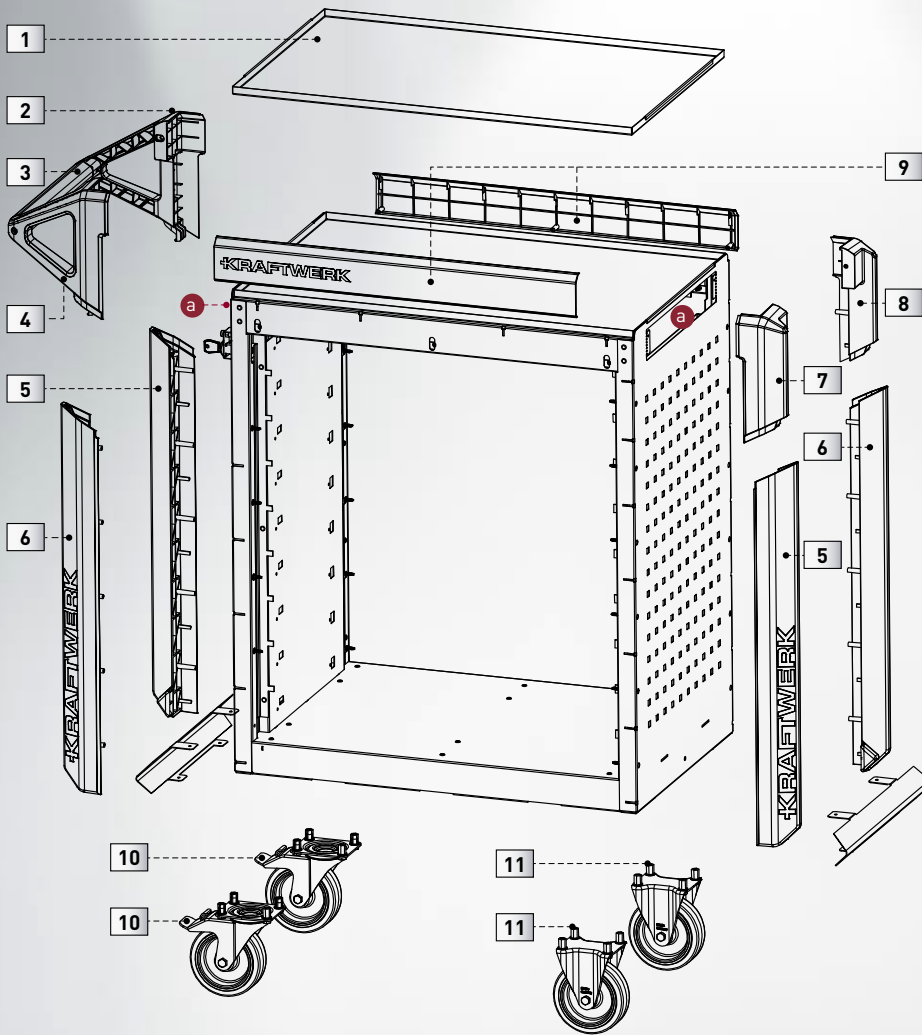

SCHUBLADEN

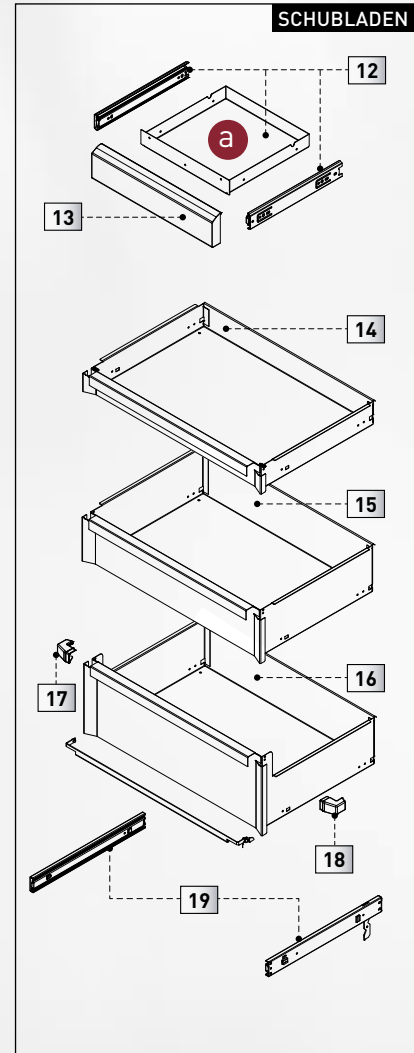

Nr.	Art.	Beschreibung	Anz.	CHF
1	191.800.017	Edelstahlwanne PT800	1	69.90
2	191.800.008	Handgriffverkleidung hinten PT800 & PT1000	1	95.-
3	191.800.009	Handgriffmitteleil PT800 & PT1000	1	95.-
4	191.800.007	Handgriffverkleidung vorne PT800 & PT1000	1	95.-
5	191.800.011	Eckstossleiste Typ B PT800 & PT1000	1	75.-
6	191.800.010	Eckstossleiste Typ A PT800 & PT1000	1	75.-
7	191.800.005	Eckteil-Verkleidung vorne PT800 & PT1000	1	75.-
8	191.800.006	Eckteil-Verkleidung hinten PT800 & PT1000	1	75.-
9	191.800.002	Front-/ Heckblende Kantenschutzleiste PT800	1	69.90
10	143.998.001	Lenkrolle mit Bremse für Werkstattwagen BT700/BT900/BT1100/PT800/PT1000	1	35.-
11	143.998.002	Starre Rolle für Werkstattwagen BT700/BT900/BT1100/PT800/PT1000	1	35.-
12	191.800.016	Kleine Schublade PT800 & PT1000	1	49.90
13	191.800.001	Griffverkleidung Seitenschublade PT800 & PT1000	1	49.90
14	191.800.013	Schublade PT800 75 mm	1	144.-
15	191.800.014	Schublade PT800 125 mm	1	144.-
16	191.800.015	Schublade PT800 225 mm	1	159.-
17	191.800.003	Schubladen-Eckverkleidung links PT800 & PT1000	1	25.90
18	191.800.004	Schubladen-Eckverkleidung rechts PT800 & PT1000	1	25.90
19	191.117.009	Schiene für BT700/BT900/BT1100/PT800/PT1000 mit Kippschutz, + haken	2	23.20



WERKSTATTWAGEN

PT1000

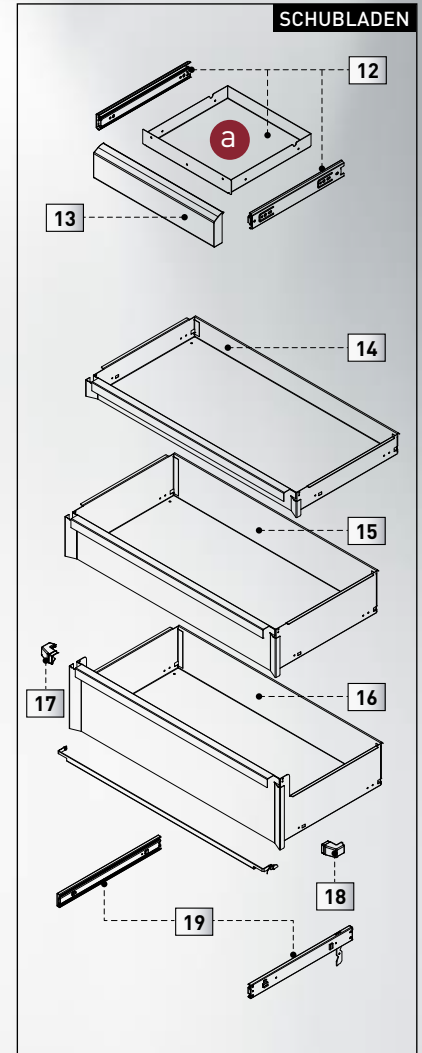
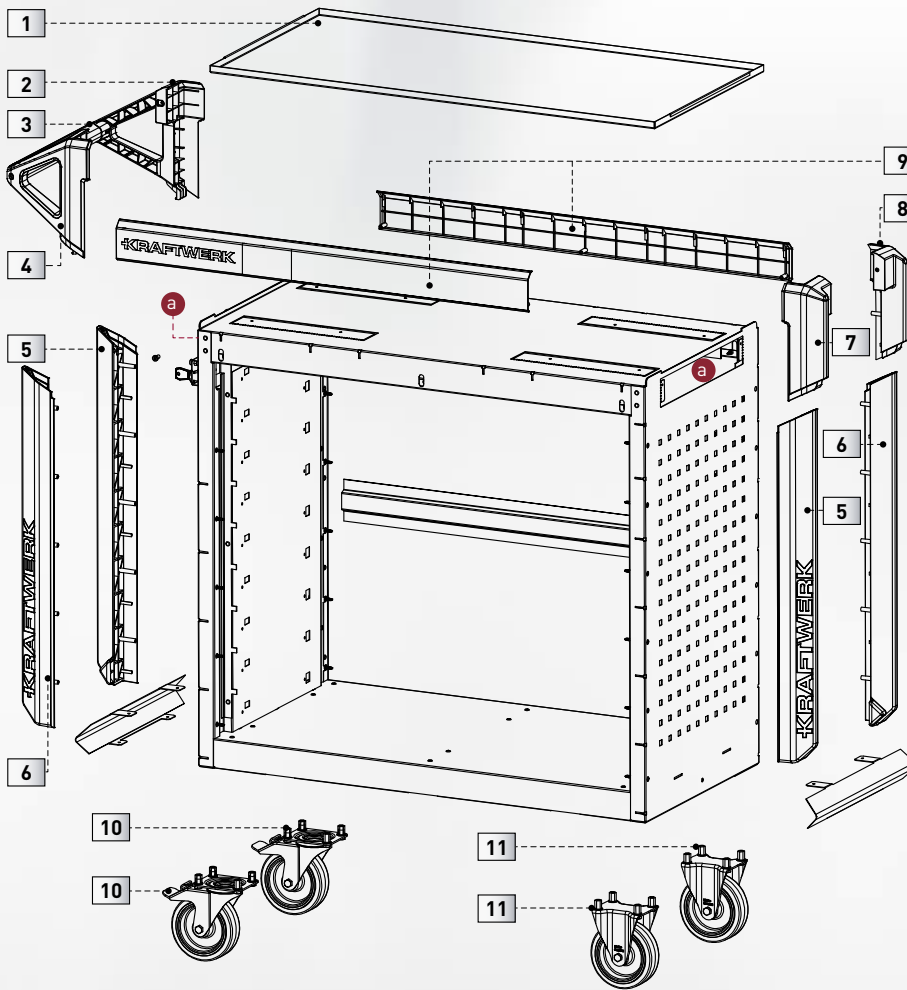

Nr.	Art.	Beschreibung	Anz.	CHF
1	191.100.006	Edelstahlwanne PT1000	1	159.-
2	191.800.008	Handgriffverkleidung hinten PT800 & PT1000	1	95.-
3	191.800.009	Handgriffmittelteil PT800 & PT1000	1	95.-
4	191.800.007	Handgriffverkleidung vorne PT800 & PT1000	1	95.-
5	191.800.011	Eckstossleiste Typ B PT800 & PT1000	1	75.-
6	191.800.010	Eckstossleiste Typ A PT800 & PT1000	1	75.-
7	191.800.005	Eckteil-Verkleidung vorne PT800 & PT1000	1	75.-
8	191.800.006	Eckteil-Verkleidung hinten PT800 & PT1000	1	75.-
9	191.100.001	Front-/ Heckblende Kantenschutzleiste PT1000	1	39.-
10	143.998.001	Lenkrolle mit Bremse für Werkstattwagen BT700/BT900/BT1100/PT800/PT1000	1	35.-
11	143.998.002	Starre Rolle für Werkstattwagen BT700/BT900/BT1100/PT800/PT1000	1	35.-
12	191.800.016	Kleine Schublade PT800 & PT1000	1	49.90
13	191.800.001	Griffverkleidung Seitenschublade PT800 & PT1000	1	49.90
14	191.100.003	Schublade 75 mm für PT1000	1	79.90
15	191.100.004	Schublade 150 mm für PT1000	1	159.-
16	191.100.005	Schublade 225 mm für PT1000	1	159.-
17	191.800.003	Schubladen-Eckverkleidung links PT800 & PT1000	1	25.90
18	191.800.004	Schubladen-Eckverkleidung rechts PT800 & PT1000	1	25.90
19	191.117.009	Schiene für BT700/BT900/BT1100/PT800/PT1000 mit Kippschutz, + haken	2	23.20



WERKSTATTWAGEN

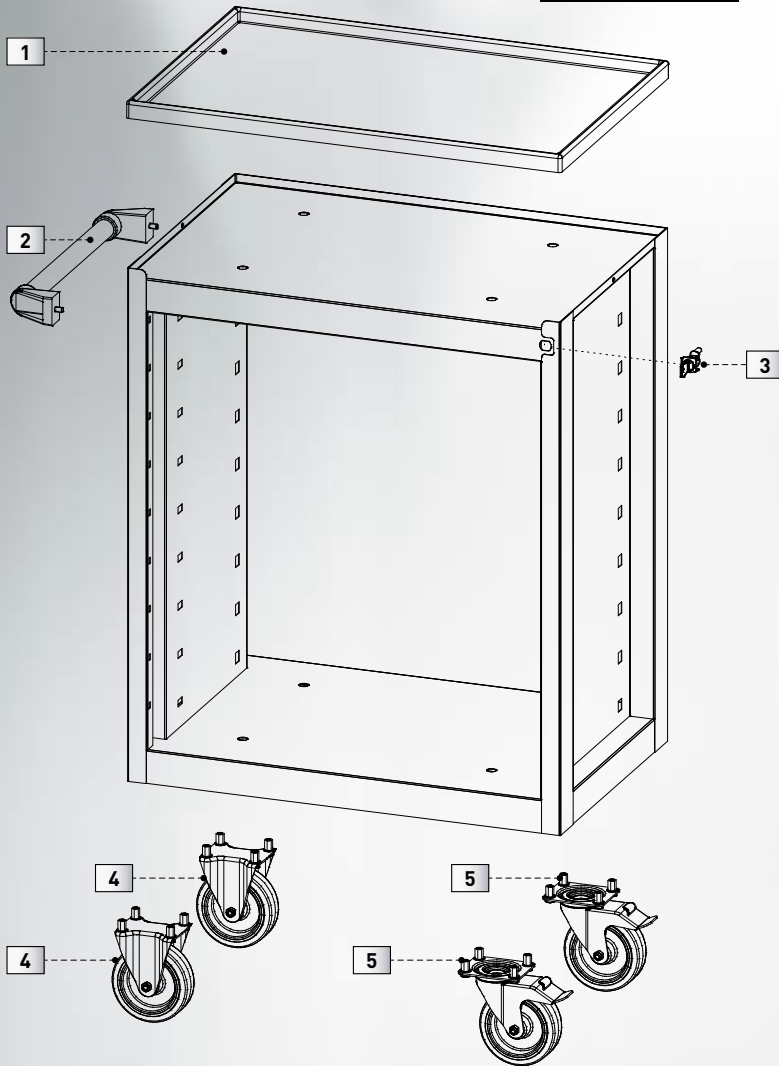

SCHUBLADEN

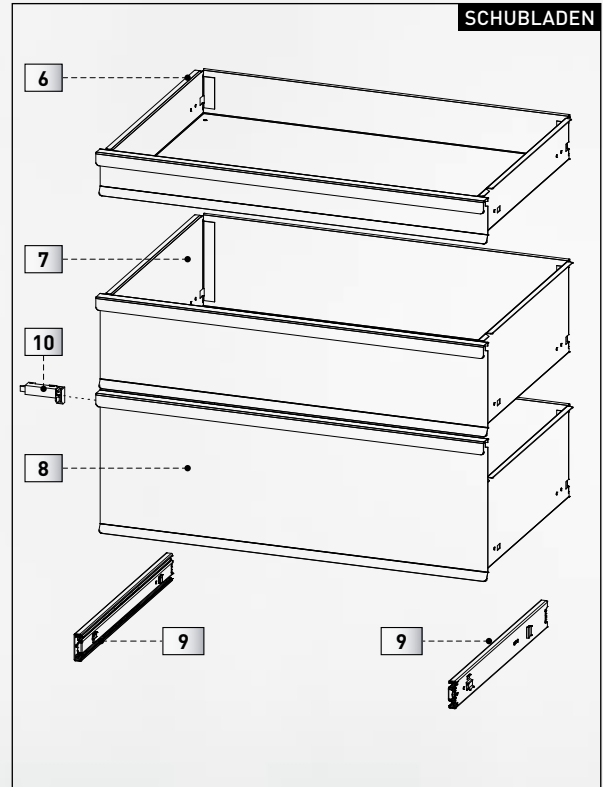

Nr.	Art.	Beschreibung	Anz.	CHF
1	143.998.204	PS (Polystyrol) Abdeckung	1	45.-
2	143.998.103	Haltegriff für Werkstattwagen LT700	1	20.-
3	191.504.001	Schloss für Werkstattwagen BT700/BT900/BT1100	1	22.80
4	143.998.002	Starre Rolle für Werkstattwagen BT700/ BT900/ BT1100	1	35.-
5	143.998.001	Lenkrolle mit Bremse für Werkstattwagen BT700/BT900/BT1100	1	35.-
6	191.503.004	Schublade Werkstattwagen LT700 H 75 mm ohne Schiene	1	195.-
7	191.503.005	Schublade Werkstattwagen LT700 150 mm ohne Schiene	1	215.-
8	191.503.006	Schublade für Werkstattwagen LT700 225 mm Höhe	1	235.-
9	191.117.010	Schiene (paar) für LT700/BT700s ohne Kippeschutzfunktion	2	15.-
10	3908-016	Schubladenverschluss-Sicherung	1	2.70

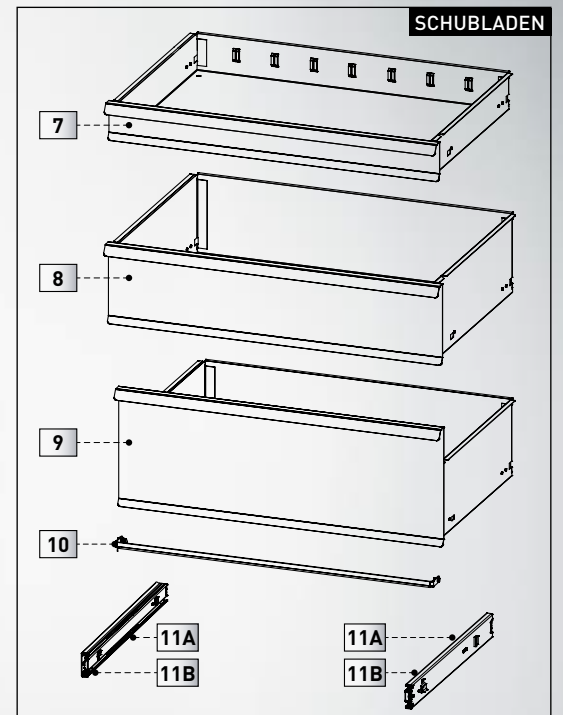
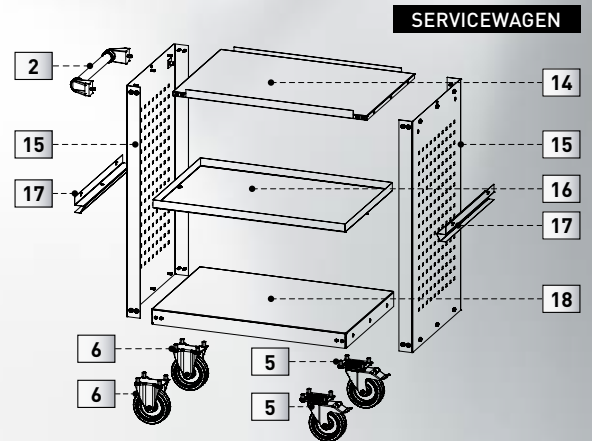
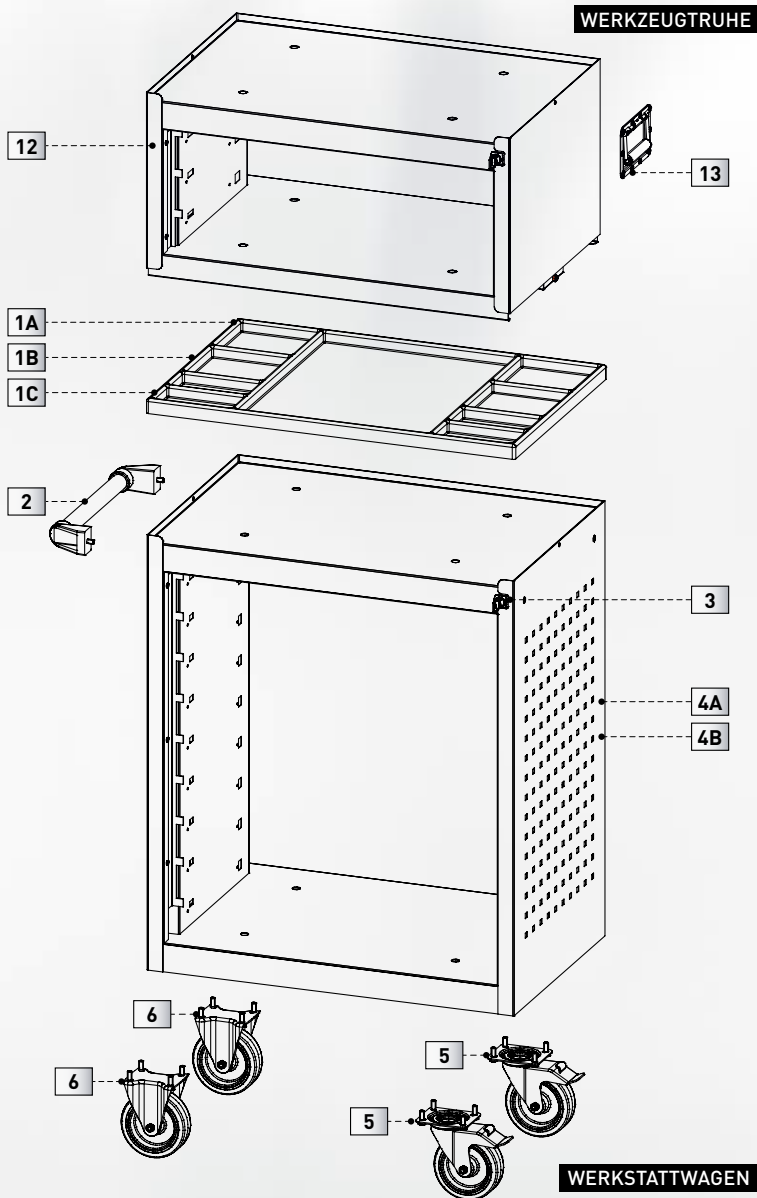

Nr.	Art.	Beschreibung	Anz.	CHF
1A	143.998.201	PS Abdeckung für Werkstattwagen BT700s/BT700	1	40.-
1B	191.501.001	Gummimatte für Werkstattwagen BT700s/ BT700	1	41.-
1C	191.505.001	Holz Top für Werkstattwagen BT700s/ BT700	1	260.-
2	143.998.101	Haltegriff für Werkstattwagen BT700s/BT700/BT900/BT1100	1	20.-
3	191.504.001	Schloss für Werkstattwagen BT700s/BT700/BT900/BT1100	1	22.80
4A	191.502.011	Korpus für Werkstattwagen BT700s	1	299.-
4B	191.502.001	Korpus für Werkstattwagen BT700	1	299.-
5	143.998.001	Lenkrolle mit Bremse für Werkstattwagen BT700s/BT700/BT900/BT1100	1	35.-
6	143.998.002	Starre Rolle für Werkstattwagen BT700s/BT700/ BT900/ BT1100	1	35.-
7	191.503.001	Schublade für Werkstattwagen BT700s/BT700/ BT1100 75 mm Höhe	1	198.-
8	191.503.002	Schublade für Werkstattwagen BT700s/BT700/ BT1100 150 mm Höhe	1	215.-
9	191.503.003	Schublade für Werkstattwagen BT700s/BT700/ BT1100 225 mm Höhe	1	229.-
10	191.504.002	Entriegelungs Leiste für Schublade BT700s/BT700/ BT1100	1	16.90
11A	191.117.010	Schiene für BT700s ohne Kippschutzfunktion	2	15.-
11B	191.117.011	Schiene für BT700/BT900/BT1100 mit Kippschutz	2	14.90
12	191.507.001	Korpus zu Werkzeugtruhe 40x60	1	111.-
13	191.508.001	Griff zu Werkzeugtruhe	1	39.90
14	191.507.006	Oberboden für Servicewagen BT700	1	62.-
15	191.507.003	Seitenwand für Service Wagen BT700/ BT900	1	85.-
16	191.507.005	Mittelboden für Servicewagen BT700	1	62.-
17	191.507.010	Leiste für mittel Fachboden Service Wagen BT700/ BT900	1	47.50
18	191.507.004	Unterboden für Servicewagen BT700	1	62.-

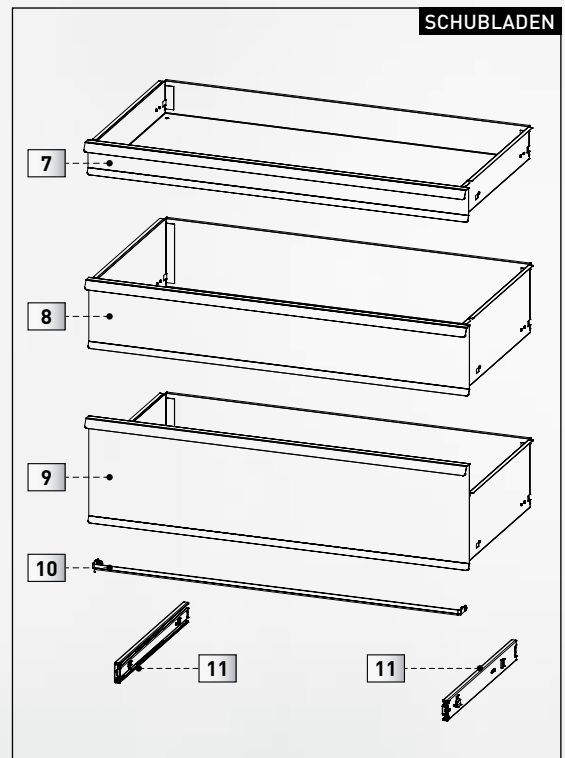
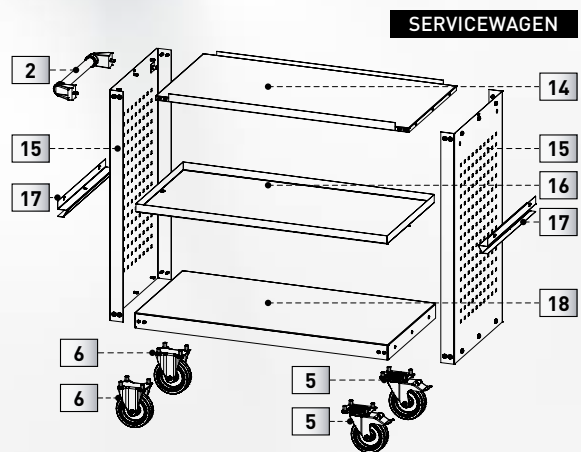
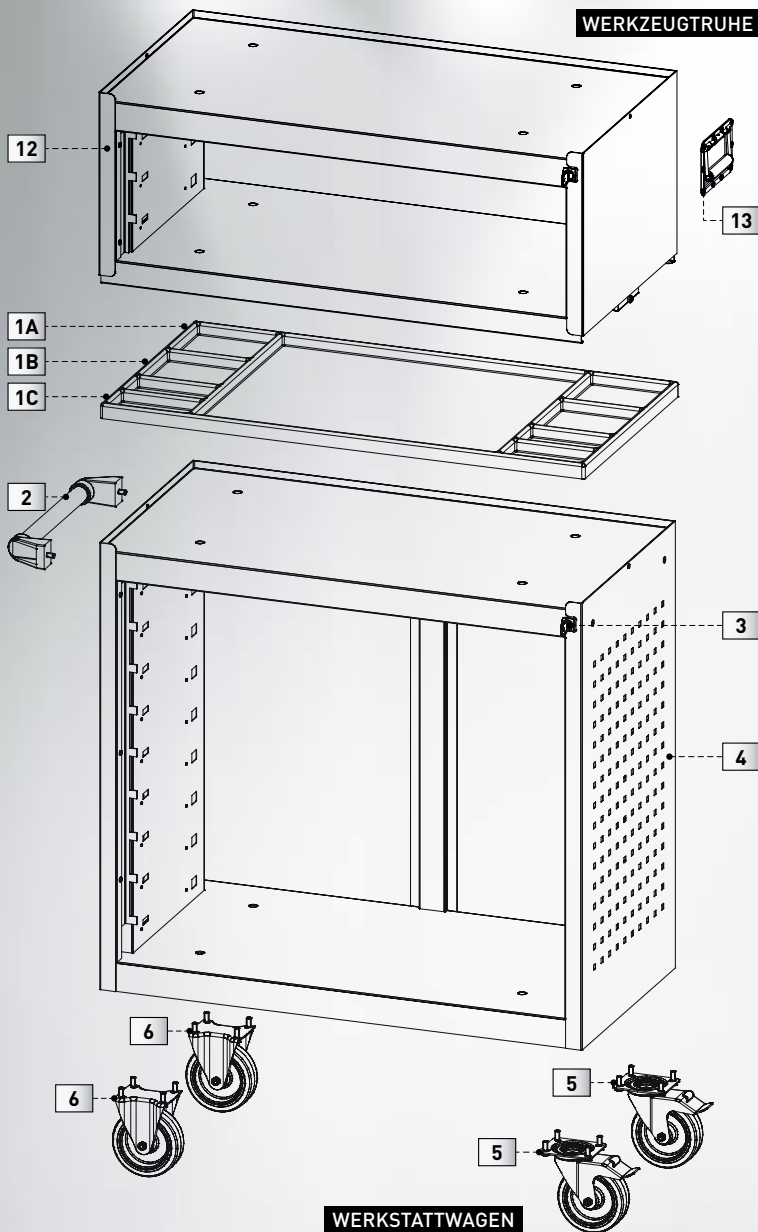

Nr.	Art.	Beschreibung	Anz.	CHF
1A	191.117.010	PS Abdeckung für Werkstattwagen BT900	1	15.-
1B	191.501.002	Gummimatte für Werkstattwagen BT900	1	52.-
1C	191.505.002	Holz Top für Werkstattwagen BT900	1	283.-
2	143.998.101	Haltegriff für Werkstattwagen BT700s/BT700/BT900/BT1100	1	20.-
3	191.504.001	Schloss für Werkstattwagen BT700s/BT700/BT900/BT1100	1	22.80
4	191.502.002	Korpus für Werkstattwagen BT900	1	319.-
5	143.998.001	Lenkrolle mit Bremse für Werkstattwagen BT700s/BT700/BT900/BT1100	1	35.-
6	143.998.002	Starre Rolle für Werkstattwagen BT700s/BT700/ BT900/ BT1100	1	35.-
7	191.503.011	Schublade für Werkstattwagen BT900 75 mm Höhe	1	215.-
8	191.503.012	Schublade für Werkstattwagen BT900 150 mm Höhe	1	235.-
9	191.503.013	Schublade für Werkstattwagen BT900 225 mm Höhe	1	259.-
10	191.504.003	Entriegelungs Leiste für Schublade BT900	1	18.-
11	191.117.011	Schiene für BT700/BT900/BT1100 mit Kippschutz	2	14.90
12	191.507.002	Korpus zu Werkzeugtruhe 40x80	1	122.-
13	191.508.001	Griff zu Werkzeugtruhe	1	39.90
14	191.507.009	Oberboden für Servicewagen BT900	1	68.-
15	191.507.003	Seitenwand für Service Wagen BT700/ BT900	1	85.-
16	191.507.008	Mittelboden für Servicewagen BT900	1	68.-
17	191.507.010	Leiste für mittel Fachboden Service Wagen BT700/ BT900	1	47.50
18	191.507.007	Unterboden für Servicewagen BT900	1	68.-

WERKSTATTWAGEN

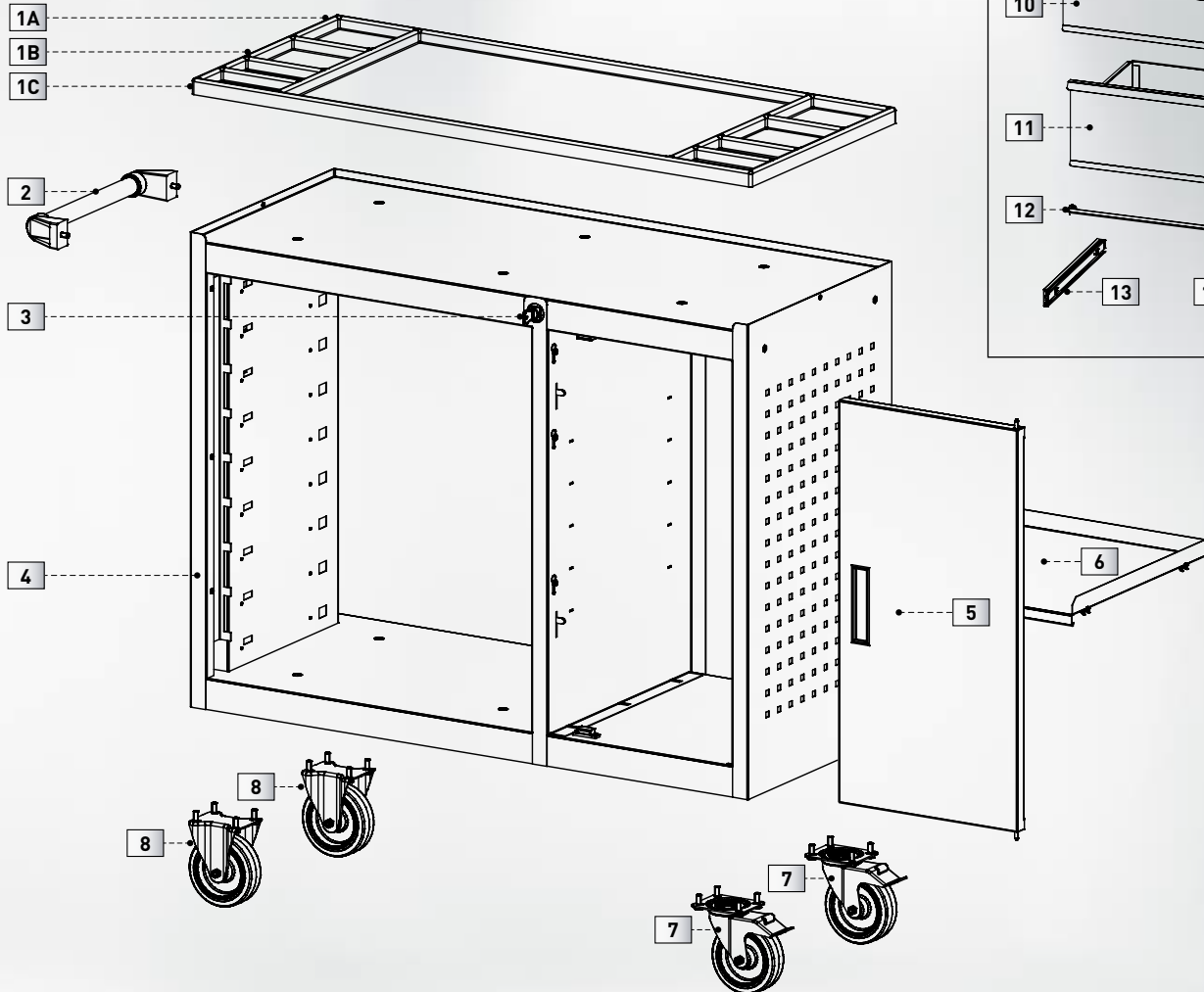

SCHUBLADEN

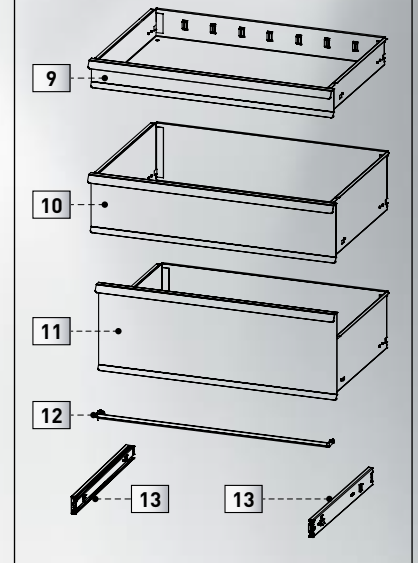

Nr.	Art.	Beschreibung	Anz.	CHF
1A	143.998.203	PS Abdeckung für Werkstattwagen BT1100	1	65.-
1B	191.501.003	Gummimatte für Werkstattwagen BT1100	1	56.-
1C	191.505.003	Holz Top für Werkstattwagen BT1100	1	319.-
2	143.998.101	Haltegriff für Werkstattwagen BT700s/BT700/BT900/BT1100	1	20.-
3	191.504.001	Schloss für Werkstattwagen BT700s/BT700/BT900/BT1100	1	22.80
4	191.502.003	Korpus für Werkstattwagen BT1100	1	359.-
5	191.506.001	Türe für Werkstattwagen BT1100	1	111.-
6	191.506.011	Fachboden für Werkstattwagen BT1100	1	119.-
7	143.998.001	Lenkrolle mit Bremse für Werkstattwagen BT700s/BT700/BT900/BT1100	1	35.-
8	143.998.002	Starre Rolle für Werkstattwagen BT700s/BT700/ BT900/ BT1100	1	35.-
9	191.503.001	Schublade für Werkstattwagen BT700s/BT700/ BT1100 75 mm Höhe	1	198.-
10	191.503.002	Schublade für Werkstattwagen BT700s/BT700/ BT1100 150 mm Höhe	1	215.-
11	191.503.003	Schublade für Werkstattwagen BT700s/BT700/ BT1100 225 mm Höhe	1	229.-
12	191.504.002	Entriegelungs Leiste für Schublade BT700s/BT700/ BT1100	1	16.90
13	191.117.011	Schiene für BT700/BT900/BT1100 mit Kippschutz	2	14.90

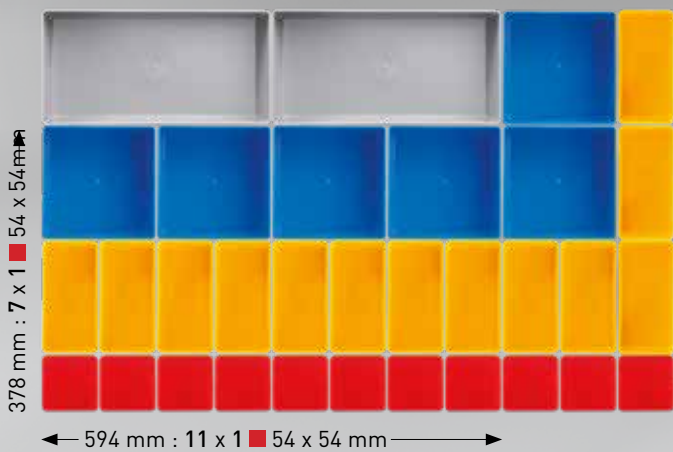
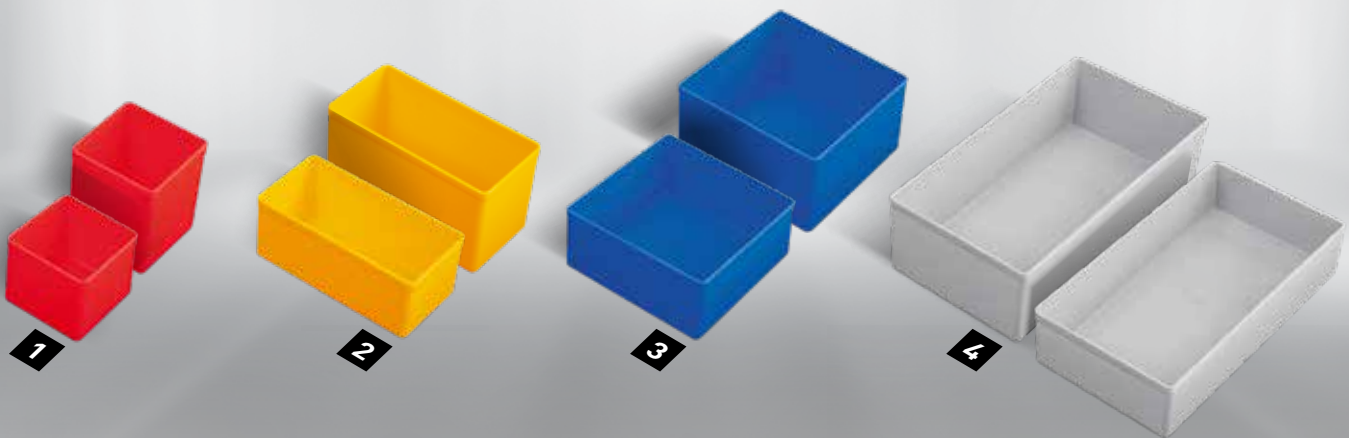

Art.	Beschreibung	CHF
198.000.018	Einsatzbox Nr. 1-45 1 B 54 x T 54 x H 45 mm	0.80
198.000.022	Einsatzbox Nr. 1-63 1 B 54 x T 54 x H 63 mm	1.-
198.000.019	Einsatzbox Nr. 2-45 2 B 108 x T 54 x H 45 mm	1.10
198.000.023	Einsatzbox Nr. 2-63 2 B 108 x T 54 x H 63 mm	1.30
198.000.020	Einsatzbox Nr. 3-45 3 B 108 x T 108 x H 45 mm	1.60
198.000.024	Einsatzbox Nr. 3-63 3 B 108 x T 108 x H 63 mm	2.10
198.000.021	Einsatzbox Nr. 4-45 4 B 108 x T 216 x H 45 mm	2.60
198.000.025	Einsatzbox Nr. 3-63 4 B 108 x T 216 x H 63 mm	3.40



<p>Modell- und Preisänderungen sowie Verfügbarkeit vorbehalten.</p> <p>Preise in CHF inkl. MwSt zuzüglich vRG</p> <p>Distribution: KRAFTWERK Schweiz AG info.ch@kraftwerktools.com</p> <p>01.04.2024 - 31.01.2025 (Verlängerung der Laufzeit möglich)</p>	<p>Ihr Fachhändler:</p>
---	-------------------------