

KRAFTWERK®

FAVORITE TOOLS SINCE 1979

PT LINE

BT LINE

LT LINE

PT800

 **MADE IN GERMANY**

from page 2

TOOL CABINETS

2023

Validity 01.05.2023 - 31.01.2024



NEW PRODUCTS

450 kg load capacity (dynamic)

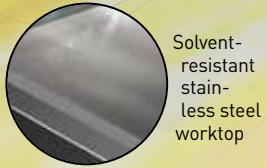

Solvent-resistant stainless steel worktop



Ergonomic handle with non-slip grip surface, **KRAFTWERK-DESIGN**



Central locking of all drawers by cylinder lock in protected position integrated in handle



Side panels with perforated wall pattern for optimized compatibility with our hook systems



All-round **ABS** and **TPR** bumper protection

With two fixed and swivel castors with brakes

Anti-tilt function
Simultaneous opening of several drawers not possible

Intelligent use of space with additional small side drawers on both sides for storing personal items



7 drawers with full extension ball-bearing rails and 45 kg load capacity each



360°- protection even when drawer is opened due to drawer corner protection



BTG
Back to Germany



Art. 101.417.000	L1	L2	L3	STD	
	L1	800 mm	479 mm	1000 mm	450 kg
	L4	600 mm	400 mm	73 mm	45 kg
	L5	600 mm	400 mm	152 mm	45 kg



Art. 102.417.001

PRO LINE Mobile Tool Cabinet PT800, 7 drawers, 103 pcs.

MADE IN GERMANY

Specialised workshop equipment with 103 tools

Embedded in 6 EVA tool inlays

1/4" + 1/2" reversible ratchets, Bits and extensions

1/4" sockets: 3.5 - 14 mm

1/2" sockets: 10 - 34 mm

Combination spanners: 8 - 19 mm

Pliers assortment

Impact tools

PROLINE screwdriver assortment 4 mm - 8 mm, PH1 + PH2

€ 1.599,-
€ 2.159,-



NEW PRODUCTS

Art. 102.417.005

PRO LINE Mobile Tool Cabinet PT800, 7 drawers, 189 pcs.

MADE IN GERMANY

Specialised workshop equipment with 189 tools

Embedded in 7 EVA tool inlays

1/4" + 3/8" + 1/2" ratchets

1/4" sockets: 4 - 14 mm

3/8" sockets: 8 - 24 mm

1/2" sockets: 10 - 32 mm

Combination spanners: 5.5 - 24 mm

PROLINE screwdriver assortment slotted 4 - 8 mm, PH1 + PH2

Pliers assortment

Impact and cutting tools



PRO LINE

€ 1.699,-
~~€ 2.539,-~~



Art. 102.417.007

PRO LINE Tool cabinet PT800, 7 drawers, 238 pcs.

MADE IN GERMANY

Specialised workshop equipment with 238 tools

Embedded in 10 EVA tool inlays

Combination spanners: 5.5 - 24 mm

1/4"+3/8"+1/2" reversible ratchets

1/4" sockets: 3.5 - 14 mm

3/8" sockets: 8 - 24 mm

1/2" sockets: 10 - 32 mm

1/2" Hexagon sockets 55 mm: 5 - 10 mm

1/2" Multi-tooth sockets 55 mm: M5 - M12

1/2" Hexagon sockets 100 mm: 6 - 12 mm

1/2" Multi-tooth sockets 100 mm: M5 - M10

Pliers assortment

PROLINE screwdriver assortment slotted 4 mm - 8 mm, PH1 + PH2

Percussion and cutting tools

Files set



PRO LINE

€ 1.999,-
~~€ 2.809,-~~





Art. 102.417.004

PRO LINE Workshop trolley PT800, 7 drawers, 220 pcs.

MADE IN GERMANY

Specialised workshop equipment with 220 tools, embedded in 10 EVA tool inlays

Combination spanners: 5.5 - 24 mm

1/4" + 3/8" + 1/2" reversible ratchets and extensions

1/4" sockets (hex.): 3.5 - 14 mm

3/8" sockets (6ct.): 8 - 24 mm

1/2" sockets (6ct.): 10 - 32 mm

1/2" Bit sockets TX, hexagon socket, multi-tooth

Pliers assortment

PROLINE screwdriver assortment slotted 4 - 8 mm, PH1 + PH2, TX

Percussion tools

€ **2.199,-**
~~€ 2.899,-~~



PRO LINE

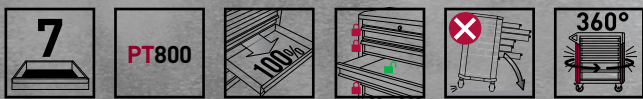

Art. 101.417.000	L1	L2	L3	ΔT	
	800 mm	479 mm	1000 mm	450 kg	
	L4	600 mm	400 mm	73 mm	45 kg
	L5	600 mm	400 mm	152 mm	45 kg





PRO LINE



€2.299,-
€3.119,-



Art. 102.417.006

PRO LINE Mobile Tool Cabinet PT800, 7 drawers, 274 pcs.

MADE IN GERMANY

274 high-quality tools in EVA tool inserts

Combination spanners: 5.5 - 24 mm

1/4" + 3/8" + 1/2" reversible ratchets and extensions

1/4" sockets (hex.): 3.5 - 14 mm

3/8" sockets (6ct.): 8 - 24 mm

1/2" sockets (6ct.): 10 - 32 mm

Pliers set

Angle spanner assortment

Circlip pliers set

PROLINE Screwdriver assortment slotted 4 mm - 8 mm, PH1 + PH2

Grip pliers set

Percussion and cutting tools

File set



**NEW
PRODUCTS**

PRO LINE

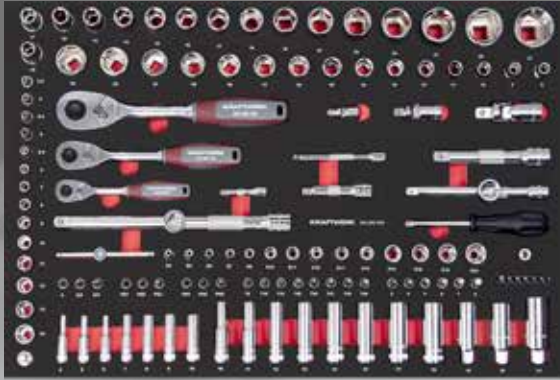

€2.299,-
~~€3.413,-~~

Art. 102.417.009

PRO LINE Mobile Tool Cabinet PT800, 7 drawers, 283 pcs.

MADE IN GERMANY

Specialised workshop equipment with 283 tools

Embedded in 13 EVA tool inlays

1/4" + 3/8" + 1/2" reversible ratchets and extensions

1/4" sockets (hex.): 3.5 - 14 mm

3/8" sockets (6ct.): 8 - 24 mm

1/2" sockets (6ct.): 10 - 32 mm

Combination spanners: 5.5 - 24 mm

Ratchet combination spanners: 8- 24 mm

Seegering pliers set

1/2" Bit socket spanner set TX, Hexagon socket

PROLINE screwdriver assortment slotted 4 mm - 8 mm, PH1 + PH2, TX

Percussion and cutting tools

Plier set

Angle spanner assortment



Art. 101.417.000	L1	L2	L3	ΔT	
	800 mm	479 mm	1000 mm	450 kg	
	L4	600 mm	400 mm	73 mm	45 kg
	L5	600 mm	400 mm	152 mm	45 kg





NEW PRODUCTS

Art. 102.550.502

PRO LINE

PRO LINE Mobile Tool Cabinet PT800, 7 drawers, 143 pcs.

MADE IN GERMANY

Specialised workshop equipment with 143 tools

Embedded in 9 EVA tool inlays

Reversible ratchet 1/2" with sockets: 10 - 34 mm, extensions + joint piece

Reversible ratchet 1/4" with sockets 3.5 - 14 mm,

PH1-PH3, PZ1-PZ3, TX T8-T40, Hexagon sockets 3-8 mm

Combination wrench set 8-24 mm

Pliers/scissors set

Cutting tool set

Impact tool set with locksmith's + plastic hammer

PROLINE screwdriver set slotted 4 mm - 8 mm, PH1 + PH2

File set



€ 1.899,-
~~€ 2.384,-~~

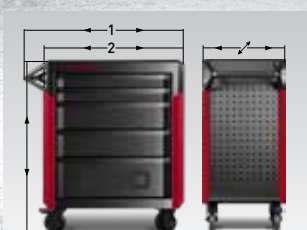

Art. 101.415.000



Art. 101.417.000

EMPTY TOOL TROLLEY

Art.	↓ mm	↔ mm	↔ mm	↘ mm	⚖ kg	—	— ! mm	↔ 400 x 600 mm	€	⚖ kg	Δ kg
101.415.000	1000	919	800	479	450	5	1 x 225;2 x 75;2 x 160 mm		1.080,- 1.490,-	45	78
101.417.000	1000	919	800	479	450	7	2 x 150;5 x 75 mm		1.080,- 1.490,-	45	87



Art. 102.381.517

BT LINE Mobile Tool Cabinet BT700, 7 Drawers, 189 pcs.

MADE IN GERMANY

Specialised workshop equipment with 189 tools

Embedded in 7 EVA tool inlays

Combination spanners: 5.5 - 24 mm

1/4" + 3/8" + 1/2" reversible ratchets

1/4" sockets: 3.5 - 14 mm

3/8" sockets: 8 - 24 mm

1/2" sockets: 10 - 34 mm

Pliers assortment

PROLINE screwdriver assortment

Slotted 4 mm - 8 mm, PH1 + PH2

Percussion and cutting tools

€ 1.399,-
~~€ 1.789,-~~



Art. 101.117.100	L1	L2	L3	ΔT
	719 mm	474 mm	1000 mm	450 kg
	L4: 600 mm	400 mm	75 mm	45 kg
	L5: 600 mm	400 mm	150 mm	45 kg



PRO LINE

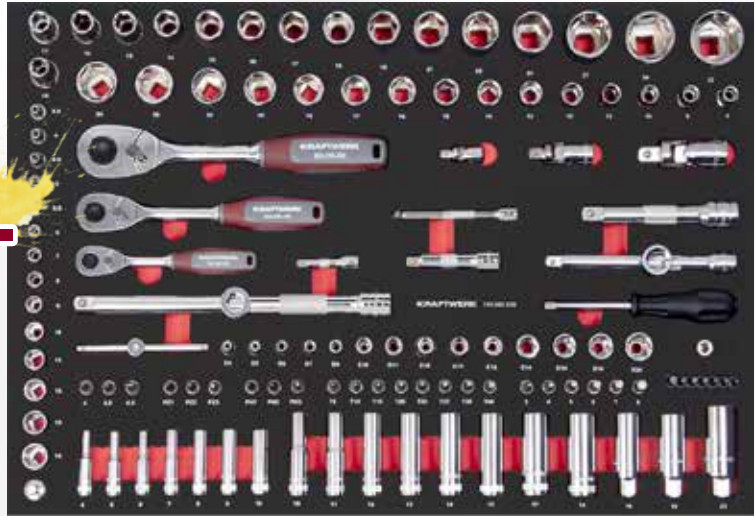

Art. 102.350.516

BT LINE Tool chest BT700, 3 drawers, 189 pcs.

MADE IN GERMANY

Specialised workshop equipment with 189 tools

Embedded in 7 EVA tool inlays

Combination spanners: 5.5 - 24 mm

1/4" + 3/8" + 1/2" ratchets

1/4" sockets: 3.5 - 14 mm

3/8" sockets: 8 - 24 mm

1/2" sockets: 10 - 32 mm

Pliers assortment

PROLINE screwdriver assortment

slotted 4 mm - 8 mm, PH1 + PH2

Percussion and cutting tools

€ 1.199,-
~~€ 1.549,-~~

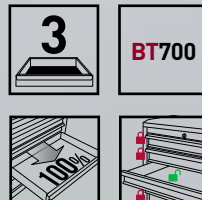
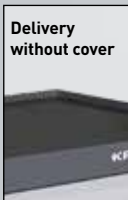

Art. 101.900.003	L1	L2	L3	ΔT
	719 mm	474 mm	369 mm	420 kg
	L4: 600 mm	400 mm	75 mm	45 kg



Art. 102.470.509

BT LINE Tool cabinet, BT700, 8 drawers, 236 pcs.

MADE IN GERMANY

Specialised workshop equipment with 236 tools

Embedded in 15 EVA tool inlay

Combination spanners: 5.5 - 24 mm

1/4"+3/8"+1/2" ratchets

1/4" sockets: 3.5 - 14 mm

3/8" sockets: 8 - 24 mm

1/2" sockets: 10 - 34 mm

Pliers assortment

PROLINE screwdriver assortment slotted 4 mm - 8 mm, PH1 + PH2, TX

Percussion and cutting tools

File set

PRO LINE



€ 1.899,-
~~€ 2.479,-~~

Art. 102.470.515

BT LINE Mobile Tool Cabinet BT700 8 Drawers, 242 pcs.

MADE IN GERMANY

Specialised workshop equipment with 242 professional tools

Embedded in 9 EVA inlays

Combination spanners: 5.5 - 32 mm

1/4"+3/8"+1/2" ratchets

1/4" sockets: 3.5 - 14 mm

3/8" sockets: 8 - 24 mm

1/2" sockets: 10 - 32 mm

With Art. 3235 torque wrench, 1/2", 40-200 Nm

Pliers assortment

PROLINE screwdriver assortment slotted 4 mm - 8 mm, PH1 + PH2, TX

Percussion, measuring and cutting tools

Files set

PRO LINE



€ 1.999,-
~~€ 2.670,-~~

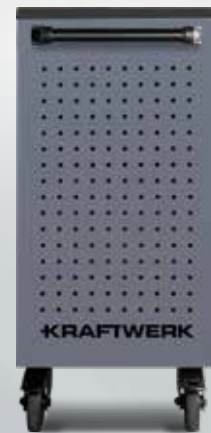

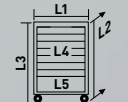
Art. 101.118.100	L1	L2	L3	GT
	719 mm	474 mm	1000 mm	450 kg
L4	600 mm	400 mm	75 mm	45 kg
L5	600 mm	400 mm	150 mm	45 kg





€1.399,-
~~€1.669,-~~



PRO LINE



Art. 101.118.100	L1	L2	L3	ΔT
	719 mm	474 mm	1000 mm	450 kg
	600 mm	400 mm	75 mm	45 kg
	600 mm	400 mm	150 mm	45 kg

Art. 102.118.101

BT LINE Mobile Tool Cabinet BT700, 8 drawers, 143 pcs.

- MADE IN GERMANY
- Specialised workshop equipment with 143 professional tools
- Embedded in 9 EVA tool inlay
- Combination spanners: 5.5 - 24 mm
- 1/4" + 1/2" ratchets
- 1/4" sockets: 3.5 - 13 mm
- 1/2" sockets: 1 - 34 mm
- Pliers assortment
- PROLINE screwdriver assortment slotted 4 mm - 8 mm, PH1 + PH2
- Percussion and cutting tools
- Files set





Rectangular perforated side walls
Easy attachment of accessories.

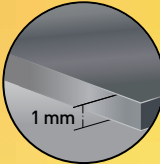

Construction
Very sturdy double-walled sheet steel construction.



2 swivel castors, with brakes, 2 fix
Thermoplastic rubber wheel, plastic rim.

Central lock of all drawers
Central lock of all drawers at the side with a cylinder lock.



Anti-tilt function
Simultaneous opening of several drawers not possible



Larger and more stable drawers
Reinforced drawers and drawer runners with full extension.



Art. 102.117.103

BASIC LINE Mobile Tool Cabinet BT700, 7 Drawers, 337 pcs.

- MADE IN GERMANY
- Specialised workshop equipment with 337 tools
- Embedded in 4 EVA tool inlays
- Combination spanners: 6 - 22 mm
- 1/4" + 1/2" ratchets and extensions
- 1/4" sockets: 4 - 14 mm
- 1/2" sockets: 10 - 32 mm
- 1/4" Bit box
- Ball end hex key set: 1.5-10mm
- TX-L-key set: T10-T50
- Files
- Slotted and PH screwdrivers
- Impact / cutting Tools
- Pliers set
- Optional Art.-No. 3235 torque wrench, 1/2", 40-200 Nm

Art. 101.117.100	L1	L2	L3	Σ
	719 mm	474 mm	1000 mm	450 kg
L4	600 mm	400 mm	75 mm	45 kg
L5	600 mm	400 mm	150 mm	45 kg

€ 1.239,-
~~€ 1.439,-~~

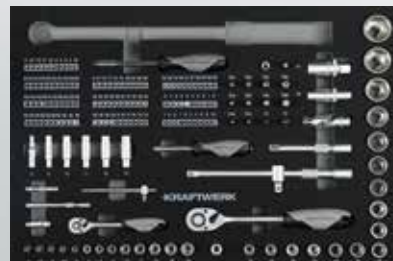



Art. 102.117.104

BASIC LINE Mobile Tool Cabinet BT700, 7 Drawers, 301 pcs.

MADE IN GERMANY
Specialised workshop equipment with 301 tools
Embedded in 6 EVA tool inlays
Combination spanners: 5.5 - 24 mm
1/4"+3/8"+1/2" ratchets
1/4" sockets: 4 - 14 mm
3/8" sockets: 10 - 24 mm
1/2" sockets: 14 - 32 mm
1/4"+1/2" slotted, PH, PZ, TX, XZN and Hexagon screwdriver Bit sockets
1/4"+3/8"+1/2" outside TX sockets
5/16" slotted, PH, PZ, TX, TX with hole, XZN, Hexagon screwdriver Bits
Slotted and PH screwdriver
Pliers and general tool
Ball end hex key set: 1.5-10mm
TX angle pin wrench set: T10-T50



€ 1.529,-
~~€ 1.739,-~~



Art. 102.117.106

BASIC LINE Mobile Tool Cabinet BT700, 7 Drawers, 274 pcs.

MADE IN GERMANY
Specialised workshop equipment with 274 tools
Embedded in 5 EVA tool inlays
Combination spanners: 5.5 - 24 mm
Double ended ring spanners: 6 - 22 mm
Ratchets 1/4" + 3/8" + 1/2"
1/4" sockets: 4 - 14 mm
3/8" sockets: 10 - 24 mm
1/2" sockets: 14 - 32 mm
1/4" + 5/16" Bit sets
Slotted, PH PH, TX, Bit screwdrivers
Allen key set: 1,5-10mm
TX-L-key set: T10-T50
Screwdriver assortment
Pliers set



€ 1.440,-
~~€ 1.720,-~~



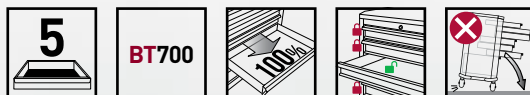

Art. 101.115.100	L1	L2	L3	ΔT
	719 mm	474 mm	1000 mm	450 kg
L4	600 mm	400 mm	75 mm	45 kg
L5	600 mm	400 mm	150 mm	45 kg
L6	600 mm	400 mm	225 mm	45 kg

€ 1.049,-
~~€ 1.246,-~~

Art. 102.115.100

BT LINE Mobile Tool Cabinet BT700, 5 Drawers, 154 pcs.

MADE IN GERMANY

Specialised workshop equipment with 154 tools

Embedded in 3 EVA tool inlays

Combination spanners: 5.5 - 24 mm

Ended ring spanners: 6 - 22 mm

1/4" + 3/8" + 1/2" ratchets

1/4" sockets: 4 - 14 mm

3/8" sockets: 10 - 24 mm

1/2" sockets: 14 - 32 mm

3/8" spark plug sockets: 16 + 21 mm

1/4" screwdriver Bits

Ball end hex key set: 1.5-10mm

TX-L-key set: T10-T50

Various adapters

Flashlight

Screwdriver assortment

Phase tester 110-250V, 6S-tested



Rectangular perforated side walls
Easy attachment of accessories.

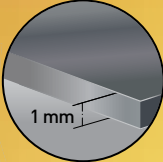

Construction
Very sturdy double-walled sheet steel construction.



2 swivel castors, with brakes, 2 fix
Thermoplastic rubber wheel, plastic rim.

Central lock of all drawers
Central lock of all drawers at the side with a cylinder lock.



Anti-tilt function
Simultaneous opening of several drawers not possible

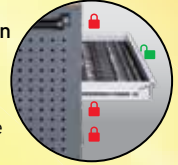

Larger and more stable drawers
Reinforced drawers and drawer runners with full extension.

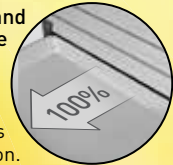

PRO LINE



Art. 101.217.100	L1	L2	L3	Σ
	919 mm	474 mm	1000 mm	450 kg
L4	800 mm	400 mm	75 mm	45 kg
L5	800 mm	400 mm	150 mm	45 kg

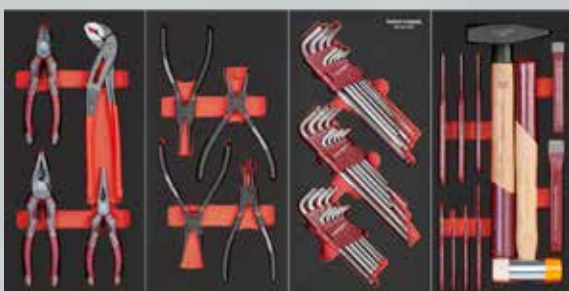

€ 1.999,-
€ 2.290,-



Art. 102.217.201

BT LINE Workshop trolley BT900 244-pcs.

- Tools in 10 special high density soft foam inserts (EVA) 60 x 20x40 cm
- 1/4"+3/8"+1/2" reversible ratchets
- 1/4" sockets: 3.5 - 14 mm, long version: 4 - 10 mm
- 1/4" slotted sockets: 4 - 6.5 mm
- Sockets: PH1 - PH3
- PZ1 - PZ3, T8 - T40, TR10 - TR40
- 1/4" Hexagon sockets 3 - 8 mm
- 1/4" external TX sockets: E4 - E11
- 3/8" sockets (hex.): 8 - 24 mm
- 3/8" sockets, long version: 10 - 19 mm
- 3/8" outside TX sockets: E10 - E20
- 3/8" spark plug sockets: 16 - 18 - 21 mm
- 1/2" sockets (6ct.): 10 - 32 mm
- Pliers set + circlip pliers
- Impact/separating tools
- Combination wrench set 5.5 - 24 mm
- PROLINE slotted screwdrivers 4 mm - 8 mm, PH1 + PH2
- PROLINE TX screwdrivers TX7- TX40
- Allen key, Hexagonal, TX, TX-TR - angle pin wrench set



PRO LINE



€ **2.490,-**
€ 2.690,-

Art. 102.217.202

BT LINE Workshop trolley BT900, 278 pcs.

- Tools in 12 special high density soft foam inserts (EVA) 60 & 20x40 cm
- 1/4"+3/8"+1/2" reversible ratchets
- 1/4" sockets (6ct.): 3.5 - 14 mm, long version: 4 - 10 mm
- 1/4" slotted sockets: 4 - 6.5 mm
- Sockets: PH1 - PH3
- PZ1 - PZ3, T8 - T40, TR10 - TR40
- 1/4" Hexagon socket 3 - 8 mm
- 1/4" external TX sockets: E4 - E11
- 3/8" sockets (hex.): 8 - 24 mm
- 3/8" sockets, long version : 10 - 19 mm
- 3/8" outside TX sockets: E10 - E20
- 3/8" spark plug sockets: 16 - 18 - 21 mm
- 1/2" sockets: 10 - 32 mm
- Pliers set + circlip pliers
- Impact/separating tools
- Combination wrench set 5.5 - 24 mm
- Ratchet combination wrench set 8 - 19 mm
- PROLINE slotted screwdriver 4 mm - 8 mm
- PROLINE PH Screwdrivers PH1 + PH2
- PROLINE TX Screwdrivers TX7- TX40
- Hexagon socket, TX, TX-TR - angle pin wrench set
- Sheet metal shears, grip & clamp pliers

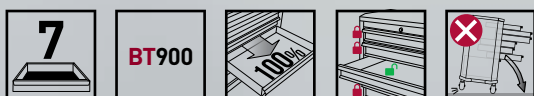

Art. 101.217.100	L1	L2	L3	ΔTΔ	
	L1	919 mm	474 mm	1000 mm	450 kg
	L4	800 mm	400 mm	75 mm	45 kg
	L5	800 mm	400 mm	150 mm	45 kg

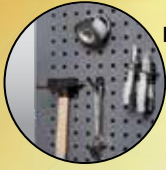

Rectangular perforated side walls
Easy attachment of accessories.

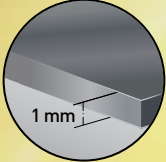

Construction
Very sturdy double-walled sheet steel construction.



2 swivel castors, with brakes, 2 fix
Thermoplastic rubber wheel, plastic rim.

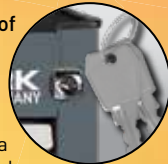

Central lock of all drawers
Central lock of all drawers at the side with a cylinder lock.



Anti-tilt function
Simultaneous opening of several drawers not possible



Larger and more stable drawers
Reinforced drawers and drawer runners with full extension.



Cabinet with shelf,
25 kg load capacity.



Art. 101.317.100	L1	L2	L3	ΔTΔ	
	L1	1119 mm	474 mm	1000 mm	450 kg
	L4	600 mm	400 mm	75 mm	45 kg
	L5	600 mm	400 mm	150 mm	45 kg



€ 2.120,-
~~€ 2.509,-~~

Art. 102.317.100

BASIC LINE Mobile Tool Cabinet BT1100, 7 Drawers, 300 pcs.

MADE IN GERMANY
300 tools in 8 special inserts of high density soft foam (EVA)

- Combination spanners 5,5 - 24 mm
- Double ended ring spanners: 6 - 22 mm
- 1/4" + 3/8" + 1/2" ratchets
- 1/4" sockets: 4 - 14 mm
- 3/8" sockets: 7 - 22 mm
- 1/2" sockets: 10 - 32 mm
- 1/4"+1/2" slotted, PH, PZ, TX, XZN and Hexagon screwdriver Bit sockets
- 1/4"+3/8"+1/2" outside TX sockets
- 5/16" slotted, PH, PZ, TX, TX with hole, XZN, Hexagon screwdriver Bits
- Pliers set
- Screwdriver assortment slotted, PH, TX
- Impact / cutting tools



Central lock of all drawers
Central lock of all drawers at the side with a cylinder lock.



Anti-tilt function
Simultaneous opening of several drawers not possible

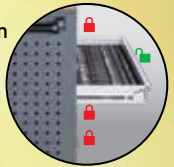

Larger and more stable drawers
Reinforced drawers and drawer runners with full extension.



Rectangular perforated side walls
Easy attachment of accessories.



Construction
Very sturdy double-walled sheet steel construction.

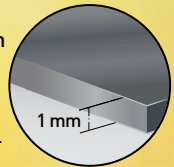

2 swivel castors, with brakes, 2 fix
Thermoplastic rubber wheel, plastic rim.



Cabinet with shelf, 25 kg load capacity.



Art. 101.401.000		L1	L2	L3	ΔT
		1805 mm	470 mm	1000 mm	450 kg
L4	600 mm	400 mm	75 mm	45 kg	
L5	600 mm	400 mm	150 mm	45 kg	
L6	600 mm	400 mm	240 mm	45 kg	
L7	365 mm	465 mm	720 mm	45 kg	

€ 3.399,-
€ 4.299,-

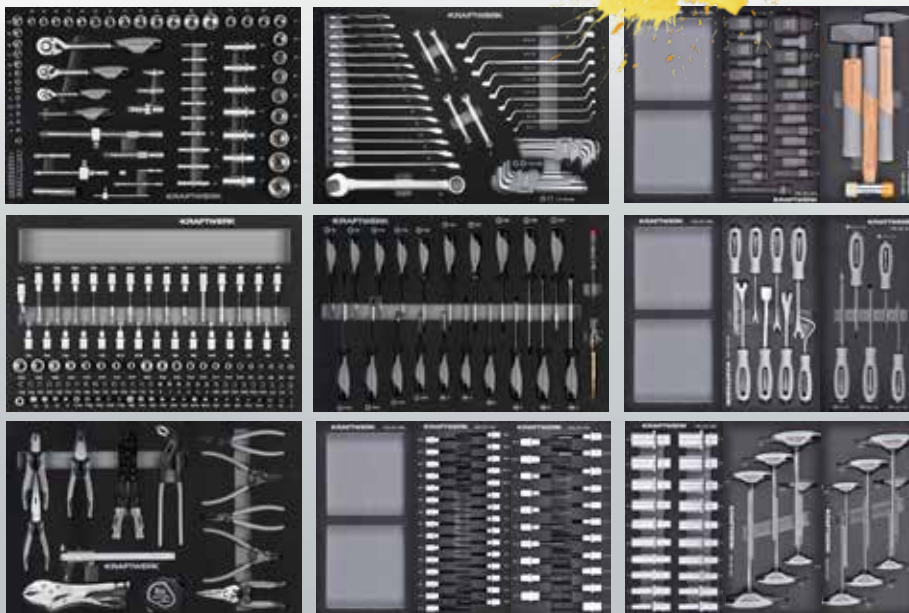

Art. 101.401.001

BASIC LINE Tool Trolley BT1800, 13 Drawers, 395 pcs.

MADE IN GERMANY
395 high-quality tools in 17 special high-density soft foam inserts (EVA)
Impact & measuring tools, screwdrivers, files, pliers
1/4", 3/8", 1/2" sockets 4 - 14 mm, 10 - 19 mm, 10 - 32 mm
1/2" Hexagon socket & Multi tooth
3/8" Hexagonal screwdriver sockets, 90 mm: 3 - 10 mm
3/8" TX screwdriver sockets, 90 mm: T8 - T50
3/8" Multi-tooth screwdriver sockets, 90 mm: M5 - M12
3/8" RIBE® screwdriver sockets, 90 mm: M5 - M12
1/2" impact sockets, long version (hex.): 13 - 32 mm
1/2" impact sockets, long version (12ct.): 30 + 36 mm
Jaw ring / ring spanner 5.5 - 24 mm

Art. 102.117.430

BASIC LINE VDE Mobile Tool Cabinet BT700, 7 Drawers, 116 pcs.

MADE IN GERMANY
Specialised workshop equipment with 116 tools
Embedded in 5 EVA tool inlays
Set of warn and safety high voltage signs
VDE slotted screwdrivers: 2.5 - 8mm
VDE PH screwdrivers: PH0 - PH3
VDE PZ screwdrivers: PZ0 - PZ3
VDE TX screwdrivers: T6 - T45
VDE Hexagon screwdrivers: 2.5 - 8mm
Voltage tester
VDE pliers
3/8" VDE ratchet
3/8" VDE sockets: 8 - 22 mm
VDE Hexagon nut driver with T-Handle: 4 - 14mm
VDE ended spanners: 8 - 19mm



Art. 101.117.101	L1	L2	L3	ΔD
	719 mm	474 mm	1000 mm	450 kg
L4	600 mm	400 mm	75 mm	45 kg
L5	600 mm	400 mm	150 mm	45 kg

€ 1.849,-
~~€ 2.979,-~~

Art. 102.117.431

BASIC LINE VDE Mobile Tool Cabinet BT700, 7 Drawers, 124 pcs.

MADE IN GERMANY
Specialised workshop equipment with 124 tools
Embedded in 5 EVA tool inlays
Set of warn and safety high voltage signs
VDE slotted screwdrivers: 2.5 - 8mm
VDE PH screwdrivers: PH0 - PH3
VDE PZ screwdrivers: PZ0 - PZ3
VDE TX screwdrivers: T6 - T45
VDE Hexagon screwdriver: 2.5 - 8mm
Voltage tester
VDE pliers
3/8" VDE ratchet
3/8" VDE sockets: 8 - 22 mm
VDE Hexagon nut driver with T-Handle: 4 - 14mm
VDE ended spanners: 8 - 19mm
Safety belt
Barrier

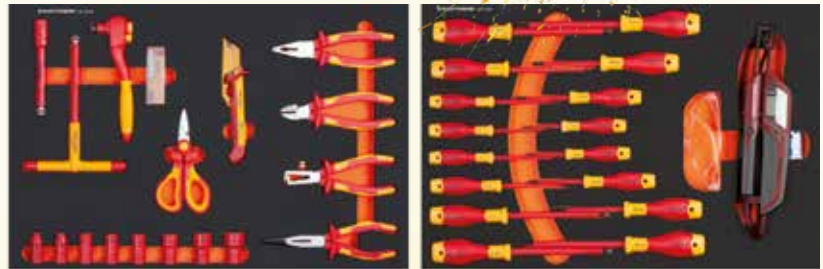

€ 2.379,-
~~€ 3.309,-~~



Art. 105.110.001

VDE Inlay with slot screwdriver/ PH/ PZ 16 pcs.

VDE slotted screwdrivers: 2,5 - 8 mm
 VDE PH screwdrivers: PH0 - PH3
 VDE PZ screwdrivers: PZ0 - PZ3
 Optional with safety glasses 807.000.001 and voltage tester 311.000.000

€139,-
~~€211,-~~



Art. 105.110.002

VDE inlay with Screwdriver TX/ Hexagon Socket, 18 pcs.

VDE TX screwdriver T6 - T45
 VDE Hexagon screwdriver 2.5 - 8 mm

€169,-
~~€239,-~~

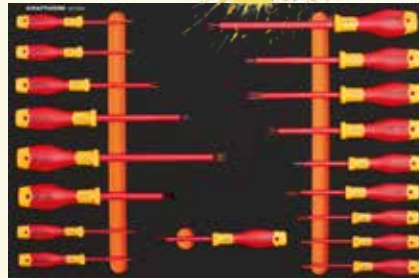

Art. 105.110.004

VDE inlay Open End Spanner / T-Handle Nut Driver inlay, 19 pcs.

VDE T-handle nut driver: 4 - 5 - 5.5 - 6 - 7 - 8 - 9 - 10 - 11 - 12 - 13 - 14 mm
 VDE open-ended spanners: 8 - 10 - 12 - 13 - 14 - 17 - 19 mm

€399,-
~~€519,-~~

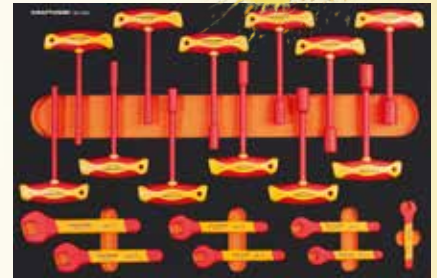

Art. 105.110.003

VDE inlay Ratchet / Sockets / Pliers inlay, 18 pcs.

3/8" VDE Ratchet
 3/8" VDE Sockets: 8 - 10 - 12 - 13 - 14 - 17 - 19 - 22 mm
 VDE combination pliers 180 mm / 7"
 VDE diagonal cutter: 160 mm / 6.1/2"
 VDE flat nose plier: 200 mm / 8"
 VDE wire stripping plier: 160 mm / 7"
 VDE cable knife
 VDE scissor

€549,-
~~€659,-~~



Art. 510.100.000

"HIGH VOLTAGE" Set of warn and safety signs high voltage containing 38 pcs.

Safety sign triangle, 2x
 Safety sign round, 1x
 Safety sign rectangular with magnet, 2x
 Safety sign rectangular with hooks 6x
 Safety sign pyramid, 1x
 Hook spare part, 4x
 Suction cup spare part, 18
 Magnet spare part, 4x

€399,-



Art. 107.000.100

Set of barrier stands + safety belts, 8 pcs.

6 barrier stands with extendable safety belts 3.6 m
 1 m height
 Yellow/ Black
 Safety belt 2pcs.
 Extendable 4.5 m
 Incl. mounting material



€1.040,-



Art. 102.107.203

LT LINE Mobile Tool Cabinet LT700 7 drawers 337 pcs.

MADE IN GERMANY
Specialised workshop equipment with 337 tools
Embedded in 4 EVA tool inlays
Combination spanners: 6 - 22 mm
1/4" + 1/2" ratchets and extensions
1/4" sockets: 4 - 14 mm
1/2" sockets: 10 - 32 mm
1/4" Bit box
Ball end hex key set: 1.5-10mm
TX-L-key set: T10-T50
Files
Slotted and PH screwdrivers
Impact / Cutting Tools
Pliers set
Optional Art.-No.-No. 3235 torque Wrench , 1/2", 40-200 Nm



€ 999,-
€ 1.099,-



Central lock of all drawers
Central lock of all drawers at the side with a cylinder lock.



Larger and more stable drawers
Reinforced drawers and drawer runners with full extension.



2 swivel castors, with brakes, 2 fix
Thermoplastic rubber wheel, plastic rim.

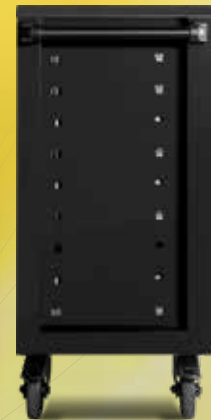

Art. 101.107.200	L1	L2	L3	δT	
	719 mm	474 mm	1000 mm	450 kg	
	L4	600 mm	400 mm	75 mm	45 kg
	L5	600 mm	400 mm	150 mm	45 kg

Art. 102.107.204

LT LINE Mobile Tool Cabinet LT700, 7 drawers, 301 pcs.

MADE IN GERMANY
Specialised workshop equipment with 301 tools
Embedded in 6 EVA tool inlays
Combination spanners: 5.5 - 24 mm
1/4" + 3/8" + 1/2" ratchets
1/4" sockets: 4 - 14 mm
3/8" sockets: 10 - 24 mm
1/2" sockets: 14 - 32 mm
1/4"+1/2" slotted, PH, PZ, TX, XZN and Hexagon Screwdriver Bit sockets
1/4"+3/8"+1/2" outside TX sockets
5/16" slotted, PH, PZ, TX, TX with hole, XZN, Hexagon screwdriver Bits
Slotted and PH screwdrivers
Pliers and general Tool
Ball end hex key set: 1.5-10mm
TX angle pin wrench set: T10-T50



€ 1.449,-
€ 1.739,-

BTG
Back to Germany





Art. 102.105.204

LT LINE Mobile Tool Cabinet LT700, 5 drawers, 259 pcs.

MADE IN GERMANY

- Specialised workshop equipment with 259 tools
- Embedded in 3 EVA tool inlays
- Combination spanners: 6 - 22mm
- 1/4" + 1/2" reversible ratchets and extensions
- 1/4" sockets (hexagonal): 4 - 14mm
- 1/2" sockets (hex): 10 - 32 mm
- 1/2" spark plug sockets: 16 + 21 mm
- 5/16" + 1/4" screwdriver Bits
- Various adapters
- Flashlight
- Screwdriver assortment
- File set
- Percussion and cutting tools

Art. 102.105.203

LT LINE Mobile Tool Cabinet LT700, 5 drawers, 337 pcs.

MADE IN GERMANY

- Specialised workshop equipment with 337 tools
- Embedded in 4 inserts, soft high-density foam (EVA)
- Combination spanners: 6-22 mm
- 1/4" + 1/2" ratchets
- 1/4" sockets: 4 - 14 mm
- 1/2" sockets: 10 - 32 mm
- Optional with item 3235 torque wrench 1/2", 40 - 200 Nm

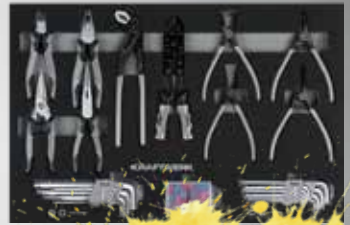
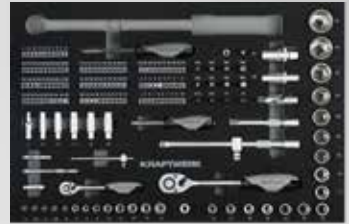
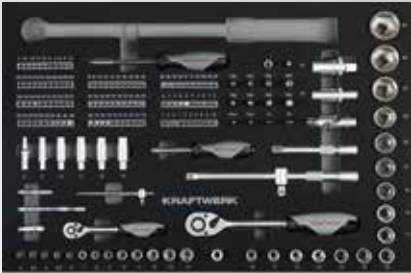

€ 949,-
€ 1.019,-

€ 1.069,-
€ 1.139,-



Art. 101.105.200	L1	L2	L3	∅D
	719 mm	474 mm	1000 mm	450 kg
L4	600 mm	400 mm	75 mm	45 kg
L5	600 mm	400 mm	150 mm	45 kg
L6	600 mm	400 mm	225 mm	45 kg





Art. 101.107.200	L1	L2	L3	ΔΔ
	719 mm	474 mm	1000 mm	450 kg
	L4 600 mm	400 mm	75 mm	45 kg
	L5 600 mm	400 mm	150 mm	45 kg



Art. 102.107.205

LT LINE Mobile Tool Cabinet LT700, 7 drawers, 155 pcs.

- MADE IN GERMANY
- Specialised workshop equipment with 155 tools
- Embedded in 7 EVA tool inlays
- Combination spanners: 6 - 32 mm
- 1/4" + 1/2" ratchets
- 1/4" sockets: 5 - 13 mm
- 1/2" sockets: 8 - 32 mm
- 1/4" outside TX sockets: E-TX E4 - E10
- 1/4" Hexagon sockets: 3 - 8 mm
- 1/4" TX sockets: TX T6 - T40
- 1/4" TX sockets: TXR TR6 - TR40
- 1/4" PH sockets: PH1 - PH2
- Pliers assortment
- Screwdriver assortment
- Percussion and cutting tools
- Files set

€ 899,-
€ 1.525,-



Art. 101.105.200



Art. 101.107.200



Art. 101.103.200



Art.	↑ mm	↔ mm	↘ mm	Kg		600 x 400 mm	€	Kg	ΔΔ kg
101.105.200	1000	719	474	450	5	1 x 225; 2 x 150; 2 x 75 mm	469,- / 649,-	45	57
101.107.200	1000	719	474	450	7	2 x 150; 5 x 75 mm	499,- / 679,-	45	59
101.103.200	1000	700	400	450	3	1 x 225; 2 x 75; 1 x 225; 2 x 75 mm	499,- / 549,-	45	55



**NEW
PRODUCT**

KRAFTWERK
MADE IN GERMANY

€499,-
~~€549,-~~

Art. 101.103.200

LT LINE Service Tool Cabinet LT700, 3 drawers, empty

MADE IN GERMANY

PS working surface resistant against chemicals

3 drawers with professional ball-bearing guide rails, full extension

Central lock of all drawers at the side with a cylinder lock

2 swivel castors, with brakes, 2 fix

Load capacity per drawer 45 kg

Total load capacity 450 kg

Can be equipped with several Kraftwerk inlays,

400 × 600 mm inside dimension

Shipment without tools and accessories

Drawers 2 × 75 mm / 2 × 150 mm

RAL 7015/ 9006



BT1800 BT LINE



Art. 101.401.000



**EMPTY
TOOL CABINETS**

Art.	↑ mm	↔ mm	↗ mm	kg		↓ mm 600 x 400 mm	€	kg	ΔΔ kg
101.401.000	1000	1805	470	450	13	1 x 225;3 x 150;9 x 75 mm	2.190,- 2.690,-	45	175.8



€ 259,-
~~€ 359,-~~

BTG
Back to Germany **BT700**

Art. 101.911.000

BT LINE Service Trolley BT700 with rubber mat
MADE IN GERMANY
Surface with rubber mat
Shelf 40 x 60 cm
RAL 7015/ 9006
2 swivel castors
Total load capacity 300 kg
H 1000 x L 719 x W 474 mm



Art. 101.911.000	L1	L2	L3	ΔΔ
	719 mm	474 mm	1000 mm	300 kg
L4	650 mm	465 mm	367 mm	100 kg
L5	650 mm	465 mm	367 mm	100 kg



€ 289,-
~~€ 399,-~~

BTG
Back to Germany **BT900**

Art. 101.911.001

BT LINE Service Trolley BT900 with rubber mat
MADE IN GERMANY
Surface with rubber mat
Shelf 40 x 80 cm
RAL 7015/ 9006
2 swivel castors
Total load capacity 225 kg
919 x 474 x 1000 mm



Art. 101.911.001	L1	L2	L3	ΔΔ
	919 mm	474 mm	1000 mm	225 kg
L4	850 mm	465 mm	367 mm	75 kg
L5	850 mm	465 mm	367 mm	75 kg

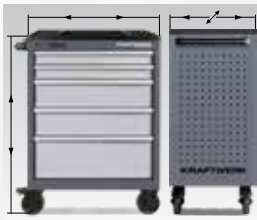

Art. 101.115.100



Art. 101.116.100



Art. 101.117.100



Art. 101.118.100



Art. 101.119.100

Art.	↑ mm	← mm	↘ mm	Kg		↓ mm 600 x 400 mm	€		Kg	Δ kg
101.115.100	1000	719	474	450	5	1 x 225;2 x 150;2 x 75 mm	649,-	749,-	45	65.28
101.116.100	1000	719	474	450	6	3 x 150;3 x 75 mm	699,-	799,-	45	66.139
101.117.100	1000	719	474	450	7	2 x 150;5 x 75 mm	649,-	869,-	45	71.71
101.118.100	1000	719	474	450	8	1 x 150;7 x 75 mm	779,-	949,-	45	73.145
101.119.100	1000	719	474	450	9	9 x 75 mm	839,-	999,-	45	73.145

**EMPTY
TOOL CABINETS**

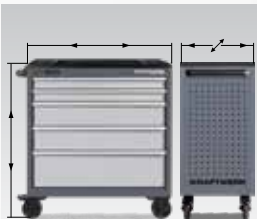

Art. 101.215.100



Art. 101.216.100



Art. 101.217.100



Art. 101.218.100



Art. 101.219.100

Art.	↑ mm	← mm	↘ mm	Kg		↓ mm 800 x 400 mm	€		Kg	Δ kg
101.215.100	1000	919	474	450	5	2 x 150;2 x 75 mm	889,-	1099,-	45	76.61
101.216.100	1000	919	474	450	6	1 x 225;2 x 150;2 x 75 mm	959,-	1199,-	45	77.377
101.217.100	1000	919	474	450	7	2 x 150;5 x 75 mm	1019,-	1249,-	45	78.15
101.218.100	1000	919	474	450	8	2 x 150;5 x 75 mm	1079,-	1299,-	45	78.932
101.219.100	1000	919	474	450	9	9 x 75 mm	1129,-	1369,-	45	79.72

**EMPTY
TOOL CABINETS**

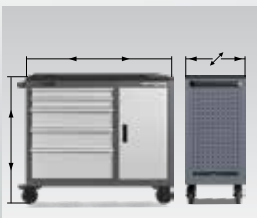

Art. 101.315.100



Art. 101.316.100



Art. 101.317.100



Art. 101.318.100



Art. 101.319.100

Art.	↑ mm	← mm	↘ mm	Kg		↓ mm 600 x 400 mm	€		Kg	Δ kg
101.315.100	1000	1119	474	450	5	2 x 150;2 x 75 mm	1149,-	1399,-	45	79.72
101.316.100	1000	1119	474	450	6	1 x 225;2 x 150;2 x 75 mm	1209,-	1499,-	45	83.718
101.317.100	1000	1119	474	450	7	2 x 150;5 x 75 mm	1299,-	1559,-	45	83.718
101.318.100	1000	1119	474	450	8	2 x 150;5 x 75 mm	1349,-	1629,-	45	85.401
101.319.100	1000	1119	474	450	9	9 x 75 mm	1409,-	1699,-	45	86.255



BTG
Back to Germany

Top for BASIC LINE Mobile Tool Cabinet

BT700/BT900, empty

MADE IN GERMANY

For all 60/40cm and 80/40 BASIC LINE Mobile Tool Cabinets

Sturdy double-walls structure

Drawers with professional ball-bearing guide rails

Central lock of all drawers at the side with a cylinder lock

Load capacity per drawer 45 kg

Art. 101.900.002

1369 x --720 x /474 mm | 27.02 kg

	mm	mm	mm
1x	75	600	400
1x	150	600	400

max.
420 kg



2
BT700

€439,-
€ 599,-

**EMPTY
TOOL CABINETS**

Art. 101.900.003

1369 x --720 x /474 mm | 30.06 kg

	mm	mm	mm
3x	75	600	400

max.
420 kg



3
BT700

€489,-
€ 659,-

Art. 101.901.002

1369 x --920 x /474 mm | 32.97 kg

	mm	mm	mm
1x	75	800	400
1x	150	800	400

max.
415 kg



2
BT900

€529,-
€ 729,-

Art. 101.901.003

1369 x --920 x /474 mm | 36.73 kg

	mm	mm	mm
3x	75	800	400

max.
415 kg



3
BT900

€629,-
€ 849,-

Delivery without cover



Perforated back panel for all BT LINE Mobile Tool Cabinets

MADE IN GERMANY

For the storage of additional tools

Clearly arranged tool storage

Sturdy sheet steel construction

Incl. fixing material



Art. 191.509.001

↓ mm	↔ mm	↙ mm	Δ kg
600	719	30	3.5

BT700



€179,-

Art. 191.509.002

↓ mm	↔ mm	↙ mm	Δ kg
800	719	30	4.6

BT700

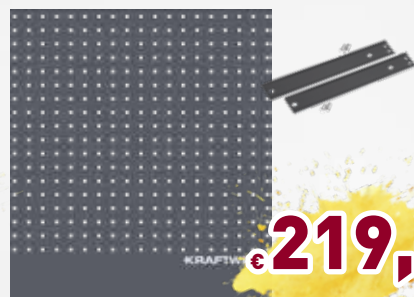

€219,-



Art. 191.509.003

↓ mm	↔ mm	↙ mm	Δ kg
600	919	30	4.0

BT900



€219,-

Art. 191.509.004

↓ mm	↔ mm	↙ mm	Δ kg
800	919	30	5.3

BT900

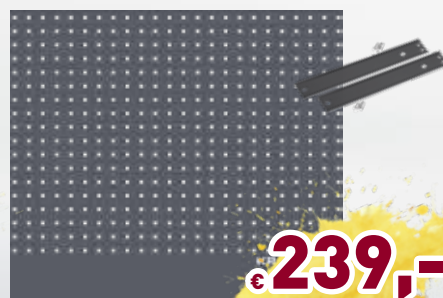

€239,-



Art. 191.509.005

↓ mm	↔ mm	↙ mm	Δ kg
600	1119	30	4.3

BT1100



€239,-

Art. 191.509.006

↓ mm	↔ mm	↙ mm	Δ kg
800	1119	30	5.7

BT1100

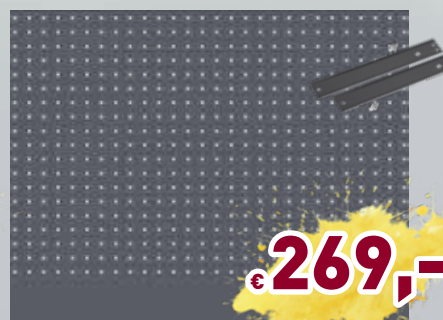

€269,-





PS (Polystyrene) cover

Made of PS (polystyrene)
Solvent resistant

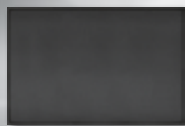

Art.	↓ mm	↔ mm	↗ mm		€	Δ kg
143.998.204	30	720	475	LT700	44,-	1.14

Rubber mat

Easy to maintain and removable
Very durable rubber work surface
Anti-slip property



Art.	↓ mm	↔ mm	↗ mm		€	Δ kg
191.501.001	3	710	465	BT700, LT700	33,-	0.18
191.501.002	3	910	465	BT900	41,-	0.24
191.501.003	3	1110	465	BT1100	45,-	0.29

PS (Polystyrene) cover

Made of PS (polystyrene)
Solvent resistant
With integrated storage compartments



Art.	↓ mm	↔ mm	↗ mm		€	Δ kg
143.998.201	28	720	475	BT700, LT700	44,-	1.07
143.998.202	26	920	475	BT900	58,-	1.3
143.998.203	26	1120	475	BT1100	62,-	1.5

Wooden panel

Easy to maintain
Multiplex beech wood worktop
Ideal worktop

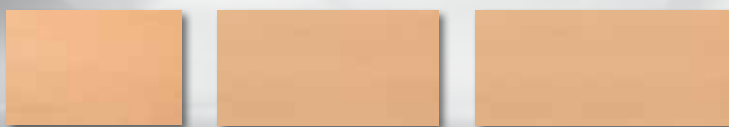

Art.	↓ mm	↔ mm	↗ mm		€	Δ kg
191.505.001	25	702	455	BT700, LT700	219,-	7
191.505.002	25	902	455	BT900	249,-	8
191.505.003	25	1102	455	BT1100	279,-	9

Stainless steel cover

Easy to maintainable and cleanable surface
Stainless Inox steel
As cover for plywood multiplex board



Art.	↓ mm	↔ mm	↗ mm		€	Δ kg
191.505.004	30	720	470	BT700, LT700	229,-	3.22
191.505.005	30	920	470	BT900	279,-	4.064
191.505.006	30	1120	470	BT1100	339,-	4.66



For
BT + PT
Series

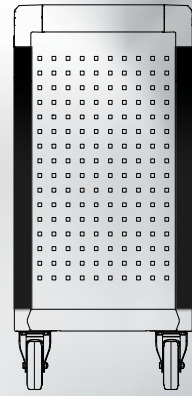
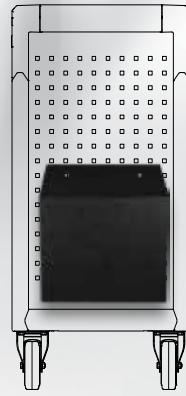
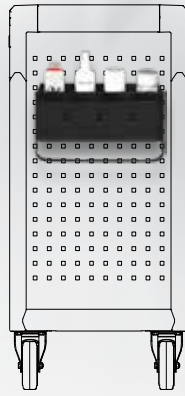
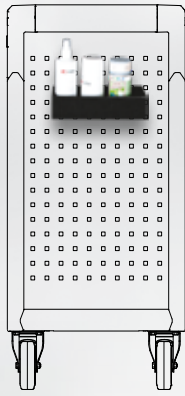
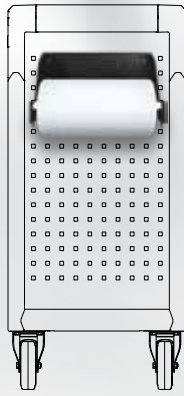

€55,-
~~€62,-~~

Art. 145.143.010

Paper roll holder

For paper rolls up to Ø 300 mm
Tube diameter = 20 mm
H 300 x W 150 x D 220 mm, Δ 1,6 kg

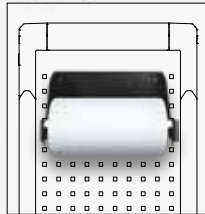

€13,90
~~€18,90~~

Art. 145.143.011

Storage compartment

For tins and small items
H 60 x W 215 x D 90 mm, Δ 0,5 kg

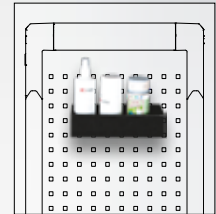

€89,-
~~€101,-~~

Art. 145.143.012

Storage compartment with handle for 8 cans

Compartment size 75 x 80 mm, large handle, variably divisible (= chemical can holder)
H 300 x W 100 x D 160 mm, Δ 2,5 kg

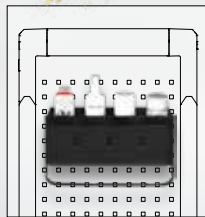

€49,-
~~€59,-~~

Art. 145.143.013

Waste basket

H 300 x W 300 x D 160 mm, Δ 3,5 kg

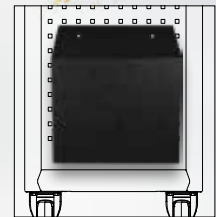

€109,-

Art. 191.510.004



€29,-

Art. 191.510.001



Edge protector

Suitable for all KRAFTWERK Mobile Tool Cabinets of the BT & LT-Series
Prevents damage to paint and bodywork
W 710 x H 35 x D 35 mm



Table Trolley

With loading platforms made of sheet steel
Edge 35 mm
Oil-tight welded
Edges with edge protection profile
Tub measure:
outside 1200 x 600 mm
inside 1021 x 596 mm



€ 379,-
~~€ 419,-~~



€ 399,-
~~€ 457,-~~

Art. No.	143.810.001	143.810.002
Description	Table Trolley	Table Trolley
Platforms made of sheet steel	2	3
Shelf load per tray evenly distributed	70 kg	70 kg
Dimensions / Weight	H 810 x W 1240 x D 600 mm (handle included) / 45 kg	H 810 x W 1240 x D 600 mm (handle included) / 51 kg

Rolling Workbench

Welded tubular steel construction
30 x 30 x 2 mm
Oil-tight welded
Edges with edge protection profile
Wheel set with 2 swivel castors with wheel stops, 2 fixed castors
Wheel diameter 200 x 50 mm
Tub measure:
outside 1200 x 600 mm
inside 1021 x 596 mm



€ 639,-



€ 799,-
~~€ 916,-~~

Art. No.	143.835.001	143.835.002
Description	Rolling Workbench	Rolling Workbench
Cabinet element or Drawer box	1 Cabinet element	1 Drawer box with 3 drawers
Drawer property	-	On roller bearings, load capacity 30 kg, individual lockable
Worktop	Beech Multiplex / 1200 x 600 x 25 mm	Beech Multiplex / 1200 x 600 x 25 mm
Shelves	2 x Beech plywood Multiplex	2 x Beech plywood Multiplex
Central lockable drawer box	✓ / H 470 x W 511 x D 600 mm	✓ / H 470 x W 511 x D 600 mm
Load capacity evenly distributed	500 kg	500 kg
Dimensions / Weight	H 835 x W 1300 x D 605 mm (handle included) / 75 kg	H 835 x W 1300 x D 605 mm (handle included) / 85 kg



€ 681,-



Art. No.	143.835.004
Description	Rolling Workbench
Drawer	2 Drawers
Drawer property	On roller bearings, load capacity 30 kg, individual lockable
Internal drawer dimensions	H 435 x D 539 mm
Worktop	Beech Multiplex / 1200 x 600 x 25 mm
Shelves	1 x Beech plywood Multiplex
Load capacity evenly distributed	500 kg
Dimensions / Weight	H 835 x W 1300 x D 605 mm (handle included) / 75 kg



€ 699,-
~~€ 799,-~~



€ 893,-

Art. No.	143.835.005
Description	Rolling Workbench
Cabinet element or Drawer box	1 Cabinet element + 1 drawer
Drawer property	On roller bearings, load capacity 30 kg, individual lockable
Internal drawer dimensions	H 459 x D 539 mm
Central lockable drawer box	√ / H 470 x W 511 x D 600 mm
Worktop	Beech Multiplex /1200 x 600 x 25 mm
Shelves	1 x Beech plywood Multiplex
Load capacity evenly distributed	500 kg
Dimensions / Weight	H 835 x W 1300 x D 605 mm (handle included) / 83 kg

Art. No.	143.835.006
Description	Rolling Workbench
Cabinet element or Drawer box	2 Cabinet elements
Drawer property	-
Internal drawer dimensions	-
Central lockable drawer box	√ / H 470 x W 511 x D 600 mm
Worktop	Beech Multiplex /1200 x 600 x 25 mm
Shelves	-
Load capacity evenly distributed	500 kg
Dimensions / Weight	H 835 x W 1300 x D 605 mm (handle included) / 83 kg



€ 889,-
~~€ 963,-~~



€ 1.399,-
~~€ 1.515,-~~

Art. No.	143.835.007
Description	Rolling Workbench
Cabinet element or Drawer box	1 Cabinet element with 4 Drawers
Drawer property	On roller bearings, load capacity 30 kg, individual lockable
Internal drawer dimensions	H 459 x D 539 mm
Central lockable drawer box	√ / H 470 x W 511 x D 600 mm
Worktop	Beech Multiplex /1200 x 600 x 25 mm
Shelves	2 x Beech plywood Multiplex
Load capacity evenly distributed	500 kg
Dimensions / Weight	H 835 x W 1300 x D 605 mm (handle included) / 85 kg

Art. No.	143.835.009
Description	Rolling Workbench
Cabinet element or Drawer box	2 Drawer box with each 4 Drawers / totally 8 Drawers
Drawer property	On roller bearings, load capacity 30 kg, individual lockable
Internal drawer dimensions	H 459 x D 539 mm
Central lockable drawer box	√ / H 470 x W 511 x D 600 mm
Worktop	Beech Multiplex /1200 x 600 x 25 mm
Shelves	-
Load capacity evenly distributed	500 kg
Dimensions / Weight	H 835 x W 1300 x D 605 mm (handle included) // 85 kg



€ 1.198,-



€ 1.399,-
~~€ 1.490,-~~

Art. No.	143.835.010
Description	Rolling Workbench
Cabinet element or Drawer box	1 Drawer box with 4 Drawers + 1 Cabinet element
Drawer property	On roller bearings, load capacity 30 kg, individual lockable
Internal drawer dimensions	H 459 x D 539 mm
Central lockable drawer box	√ / H 470 x W 511 x D 600 mm
Worktop	Beech Multiplex /1200 x 600 x 25 mm
Load capacity evenly distributed	500 kg
Dimensions / Weight	H 835 x W 1300 x D 605 mm (handle included) / 107 kg

Art. No.	143.835.011
Description	Rolling Workbench
Cabinet element or Drawer box	4 : H 90 mm / 1 : H 135 mm 1 : H 70 mm + 1 Cabinet element
Drawer property	On roller bearings, load capacity 30 kg, individual lockable
Internal drawer dimensions	5 x W 460 x D 535 mm 1 x W 995 x D 535 mm
Central lockable drawer box	√ / H 505 x W 490 x D 570 mm
Worktop	Beech Multiplex /1200 x 605 x 25 mm
Load capacity evenly distributed	450 kg
Dimensions / Weight	H 925 x W 1200 x D 605 mm (inkl. Griff) / 107 kg

Ironing Carts and Platform Trolleys

Sturdy universal trolleys for many purposes
Bed in angle steel with beech plywood floor, in strong welded construction, powder-coated
Wheel set, 2 fixed castors, solid-rubber tyres 200 x 50 mm, load capacity per wheel set 500 kg
Delivered disassembled, easy to assemble



€256,-



€269,-
€297,-



€323,-



Art. No.	143.270.001	143.270.002	143.270.003
Description	Platform Trolley	Ironing Cart	Ironing Cart
Handle height	-	950 mm	950 mm
Removable Stanchions / Height	-	-	2 x H 800 mm / removable
Load capacity evenly distributed	500 kg	500 kg	500 kg
Dimensions / Weight	H 270 x W 1200 x D 600 mm / 40 kg	H 270 x W 1200 x D 600 mm / 45 kg	H 270 x W 1200 x T 600 mm / 50 kg



€233,-
€295,-

Art. 3912

Multi-Purpose Mobile Tool Cabinet
Solid construction for universal use and with 3 big shelves
External dimensions 14 x 91 x 4 mm
Shelf width/depth 66 x 39 mm
Shelf load capacity max. 8 kg
Load capacity max. 24 kg
4 Caster wheels, Ø 1 mm, 2 with brakes



€54,-

Art. 3912-99

Waste bin
For multi-purpose trolley 3912, made of oil and acid-resistant polypropylene



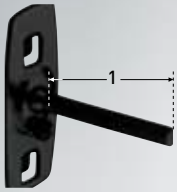

Tool holder
with straight rods

Art.	1 mm	Ø mm	ΔΔ g	€	
145.100.050	50	6	34	1,90	2,30
145.100.102	102	6	46	2,60	3,10
145.100.150	150	6	56	3,10	3,80



Double hook
with straight rods

Art.	1 mm	Ø mm	ΔΔ g	€	
145.110.050	50	6	74	3,40	5,20
145.110.102	102	6	98	3,50	6,30
145.110.150	150	6	118	3,50	6,30



Tool holder
with right angle

Art.	1 mm	Ø mm	ΔΔ g	€	
145.111.035	35	6	34	2,10	3,70
145.111.070	70	6	46	2,40	3,70
145.111.135	135	6	56	3,40	4,10

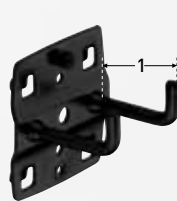

Double hook
with right angle

Art.	1 mm	Ø mm	ΔΔ g	€	
145.112.035	35	6	76	3,40	6,20
145.112.050	50	6	80	3,40	6,20
145.112.075	75	6	90	3,50	6,20
145.112.150	150	6	98	3,50	8,90

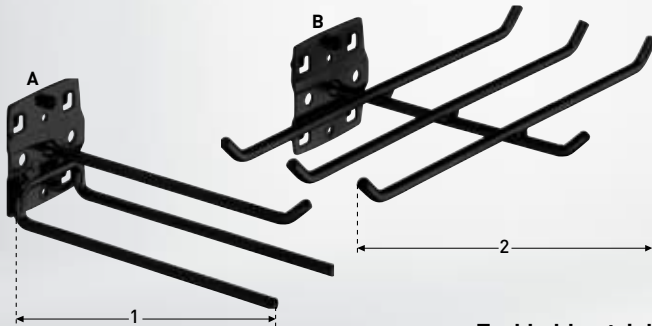

Tool holder, triple

Art.	1 mm	2 mm	Ø mm	ΔΔ g	€	
145.113.045	A	45	150	6	170	5,50 14,50
145.113.140	B	240	140	6	256	8,50 30,20



Hook
with inclined shaft

Art.	1 mm	Ø mm	ΔΔ g	€	
145.120.050	50	6	34	2,10	3,70
145.120.100	100	6	46	2,90	4,10
145.120.150	150	6	56	3,40	4,10
145.120.200	200	6	68	3,50	4,70



Tool clamp, simple

Art.	Ø mm	ΔΔ g	€	
145.122.006	6	24	3,50	4,70
145.122.010	10	25	3,50	5,10
145.122.013	13	26	3,50	5,10
145.122.016	16	27	3,50	5,10
145.122.019	19	28	3,50	5,10

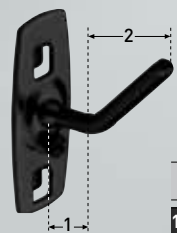

Inclined hook

Art.	1 mm	2 mm	Ø mm	ΔΔ g	€	
145.121.040	15	35	6	34	2,10	4,10



Tool Clamp, wide base plate

Art.	1 mm	Ø mm	ΔΔ g	€	
145.123.025	25	25	58	3,50	8,30
145.123.028	28	28	60	3,50	9,30
145.123.032	32	23	64	3,50	10,30

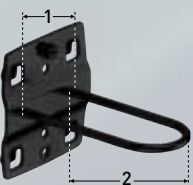

Round holder

Art.	1 mm	2 mm	ΔΔ g	€	
145.124.027	27	65	68	2,90	8,30

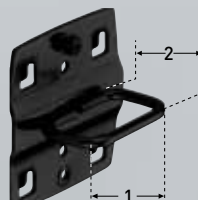

Clamp holder

Art.	1 mm	2 mm	ΔΔ g	€	
145.125.035	35	20	62	3,50	6,20
145.125.075	75	20	62	3,60	7,20



Circular holder

Art.	∅ mm	ΔΔ g	€	
145.126.060	60	72	4,80	15,50
145.126.080	80	80	5,60	16,60

Order in pairs



Tube holder

Art.	↔ mm	∅ mm	ΔΔ g	€	
145.127.060	35	60	114	4,80	15,50
145.127.100	35	100	156	5,60	16,60

Order in pairs

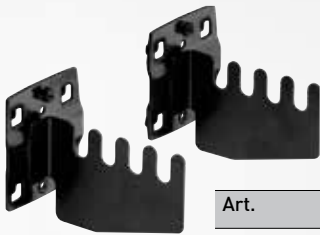

Saw holder

For 4 saws

Art.	↑ mm	↗ mm	ΔΔ g	€	
145.128.080	52	80	85	3,50	14,50



Wrench holder

For 10 wrenches

Art.	↑ mm	↗ mm	ΔΔ g	€	
145.129.227	75-145	220	480	13,90	29,20



Bit holder

For 7 Bits

Art.	↔ mm	↗ mm	ΔΔ g	€	
145.132.150	150	35	200	4,40	20,70



Tool holder

For individual modification

Art.	↔ mm	↑ mm	↗ mm	ΔΔ g	€	
145.134.340	325	55	135	1100	29,-	43,70

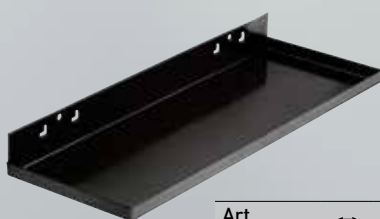

Storage shelf

For small parts and tools

Art.	↔ mm	↗ mm	ΔΔ g	€	
145.138.350	350	125	600	9,90	25,-
145.138.445	445	150	900	12,50	35,-



Height: ↑ Width: ↔ Depth: ↗

Tool holder with circular pockets

Art.	↔ mm	∅ mm	ΔΔ g	€	
145.137.001	100	70	200	6,90	25,-

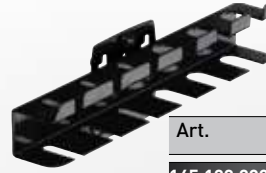

Screwdriver holder

For 6 pcs.

Art.	↔ mm	↗ mm	ΔΔ g	€		
145.129.200	6	200	30	200	6,80	20,70
145.129.390	12	390	30	400	9,80	29,20



Drill Bit holder

For 14 drills

2x each ∅ 3.0-4.2-6.5-7.5-8.5-16.5 mm / 1x each ∅ 10.5-12.5 mm

Art.	↔ mm	↗ mm	ΔΔ g	€	
145.130.200	200	28	200	6,90	20,70
145.130.390	390	28	400	12,90	36,40



Holder for Hexagonal keys

For 9 angle pin wrenches

Art.	↔ mm	↗ mm	ΔΔ g	€	
145.131.200	200	73	220	7,90	26,-



Holder for sockets

For 12 pcs.

Art.	↔ mm	↗ mm	ΔΔ g	€	
145.133.390	390	30	500	12,90	36,40



Combined holder in 2 elements

Art.	↔ mm	↗ mm	ΔΔ g	€	
145.135.150	60	150	400	11,90	50,-

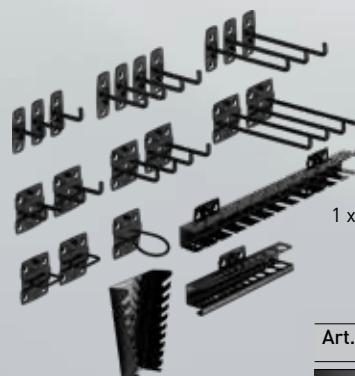

Tool holder set for wall panel, 22 pcs.

- 3 x Art. 145.111.035, L=35 mm
- 4 x Art. 145.111.070, L= 70 mm
- 3 x Art. 145.111.135, L=135 mm
- 2 x Art. 145.112.035, L= 35 mm
- 2 x Art. 145.112.075, L= 75 mm
- 2 x Art. 145.112.150, L= 150 mm
- 2 x Art. 145.125.055, W= 55 mm
- 1 x Art. 145.126.060, ∅= 60 mm
- 1 x Art. 145.129.390, for 12 screwdrivers
- 1 x Art. 145.129.227, for 10 spanners
- 1 x Art. 145.130.200, for 14 drill Bits

Art.	ΔΔ g	€	
145.100.900	2270	55,-	74,30



EVA TOOL INLAYS FOR ALL KRAFTWERK WORKSHOP TROLLEYS

For BT700, BT900, BT1100, BT1800, LT700, PT800 & PT1000



CHOOSE YOUR WORKSHOP TROLLEY ACCORDING TO YOUR NEEDS



CREATE YOUR OWN WORKSHOP:

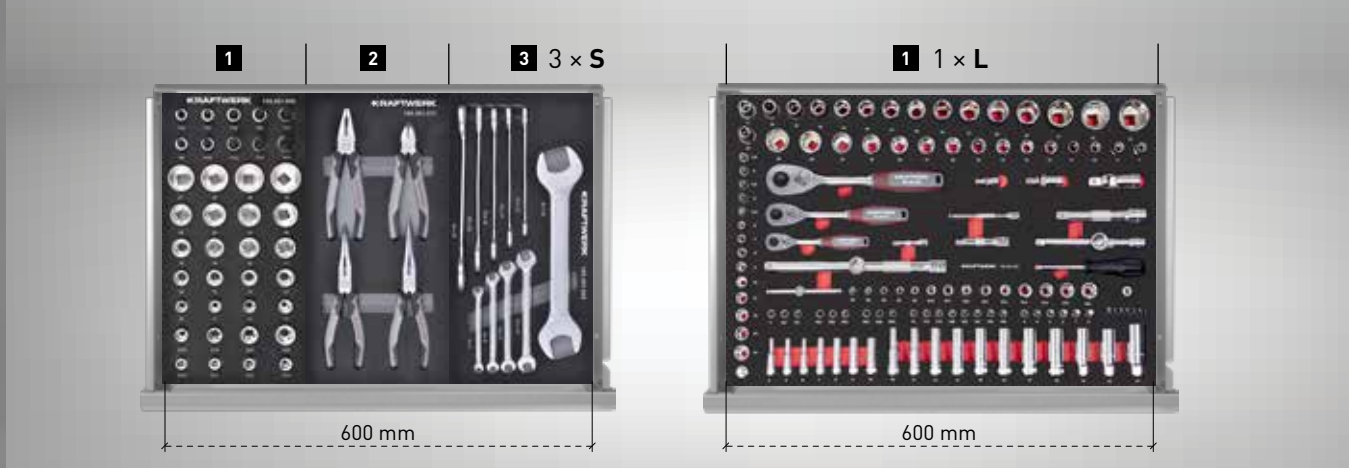

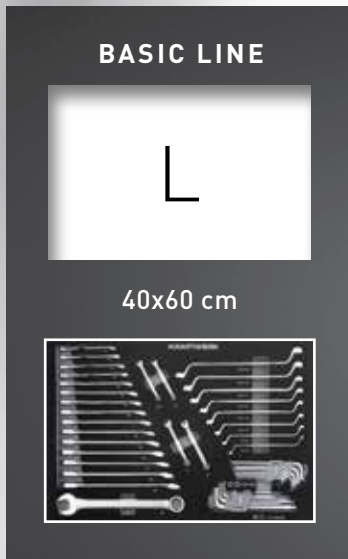
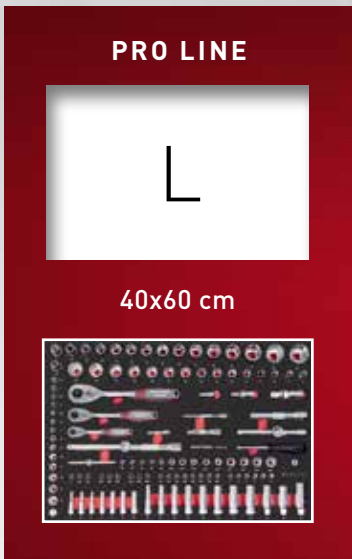

CHOOSE YOUR WORKSHOP TROLLEY ACCORDING TO YOUR NEEDS



CREATE YOUR OWN WORKSHOP:

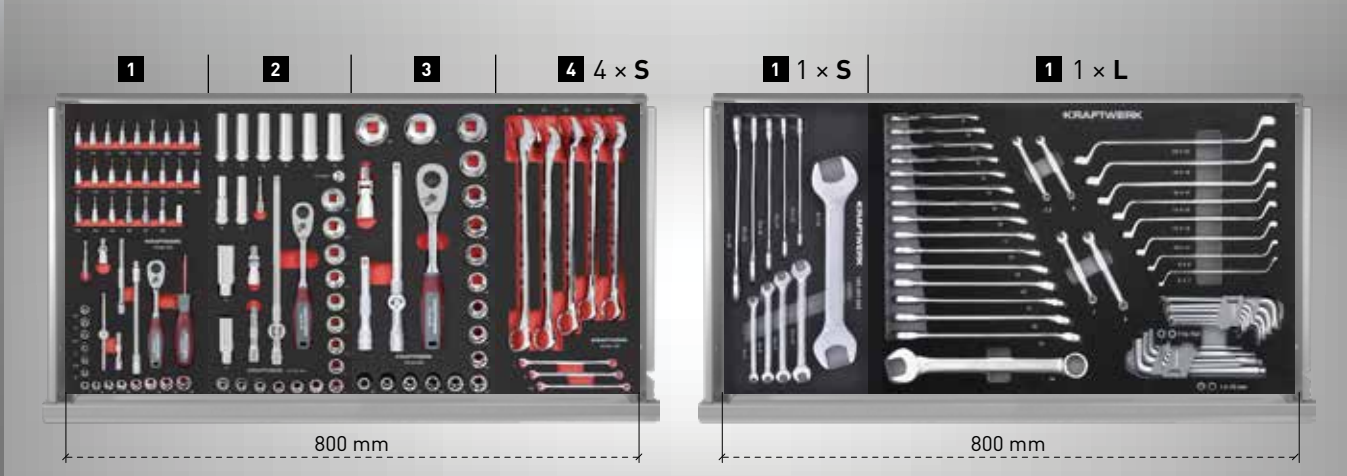

20 × 40 cm



200 × 400 × 40 mm | Δ 1.95 kg



€ 79,-
~~€ 98,-~~

Art. 105.301.001

BASIC LINE EVA 3/8" Hexagon, TX, Multi tooth, RIBE® sockets 90 mm inlay, 20 × 40 cm, 30 pcs.

3/8" Hexagon sockets 3 - 10 mm
3/8" TX sockets T8 - T50
3/8" Multi-tooth sockets M5 - M12
3/8" RIBE® sockets M5 - M12
For manual operation
Chrome vanadium / special steel tip



200 × 400 × 40 mm | Δ 4.25 kg



€ 145,-
~~€ 163,-~~

Art. 105.301.002

BASIC LINE EVA 1/2" deep impact sockets inlay, 20 × 40 cm, 16 pcs.

1/2" deep impact sockets 6-point 13 - 32 mm
1/2" deep impact sockets 12-point 30 and 36 mm
1/2" impact extension 125 mm
For machine actuation
Chrome molybdenum



200 × 400 × 40 mm | Δ 3.76 kg



€ 99,-
~~€ 115,-~~

Art. 105.301.003

BASIC LINE EVA 1/2" deep impact sockets inlay, 20 × 40 cm, 20 pcs.

1/2" deep impact sockets 6 - 32 mm
For manual operation
Chrome vanadium



200 × 400 × 40 mm | Δ 2.5 kg



€ 79,-
~~€ 94,-~~

Art. 105.301.004

BASIC LINE EVA 1/2" Hexagon, Multi tooth, RIBE® sockets 100 mm inlay, 20 × 40 cm, 21 pcs.

1/2" Hexagon sockets 6 - 17 mm
1/2" Multi-tooth sockets M5 - M16
1/2" RIBE® sockets M8 - M14
For manual operation
Chrome vanadium / special steel tip

20 × 40 cm



200 × 400 × 40 mm | Δ 2.87 kg

1/2" CrV

€ 89,-
€ 104,-

Art. 105.301.005

BASIC LINE EVA 1/2" socket inlay, 20 × 40 cm, 23 pcs.

1/2" ratchet with 150 and 200 mm extensions
1/2" sockets 8 - 32 mm
1/2" universal joint and adapter
Chrome vanadium

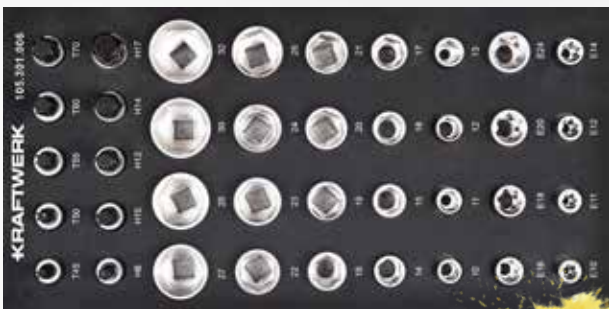

200 × 400 × 40 mm | Δ 3.22 kg

1/2" CrV

€ 99,-
€ 115,-

Art. 105.301.006

BASIC LINE EVA 1/2" sockets inlay, 20 × 40 cm, 38 pcs.

1/2" sockets: 10 - 32 mm
1/2" Hexagon sockets: 8 - 17 mm
1/2" outside TX sockets: E-TX E10 - E24
1/2" TX sockets: TX T45 - T70
For manual operation
Chrome vanadium / special steel tip

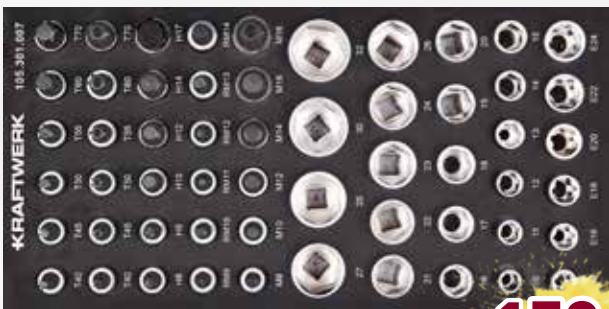

200 × 400 × 40 mm | Δ 4.99 kg

1/2" CrV

€ 159,-
€ 184,-

Art. 105.301.007

BASIC LINE EVA 1/2" sockets inlay, 20 × 40 cm, 56 pcs.

1/2" sockets: 10 - 32 mm
1/2" Hexagon sockets: 8 - 17 mm
1/2" outside TX sockets: E-TX E14 - E24
1/2" TX sockets: TX T40 - T70
1/2" TX sockets: TX TR T40 - T70
1/2" Multi-tooth sockets: M9 - M16
1/2" RIBE® sockets: M9 - M14
For manual operation
Chrome vanadium/special steel tip



200 × 400 × 40 mm | Δ 0.18 kg

€ 15,-
€ 17,-

Art. 105.301.008

BASIC LINE placeholder inlay, 20 × 40 cm

Suitable for small parts and tools
2 compartments with 170 x 130 mm each



20 × 40 cm



200 × 400 × 40 mm | Δ 2.5 kg

€79,-
~~€93,-~~

Art. 105.301.009

BASIC LINE hammer inlay, 20 × 40 cm, 3 pcs.

Hammer 300 g
Rubber hammer 300 g
Sledgehammer 1000 g

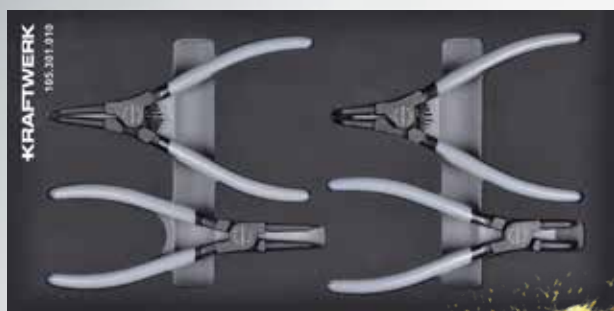

200 × 400 × 40 mm | Δ 1.65 kg

€89,-
~~€104,-~~

Art. 105.301.010

BASIC LINE EVA circlip pliers inlay, 20 × 40 cm, 4 pcs.

Circlip pliers, straight, closing, for inner rings
Circlip pliers, straight, opening, for inner rings
Circlip pliers, angled 90°, closing, for outer rings
Circlip pliers, angled 90°, opening, for outer rings
For circlips from Ø 19 - 60 mm

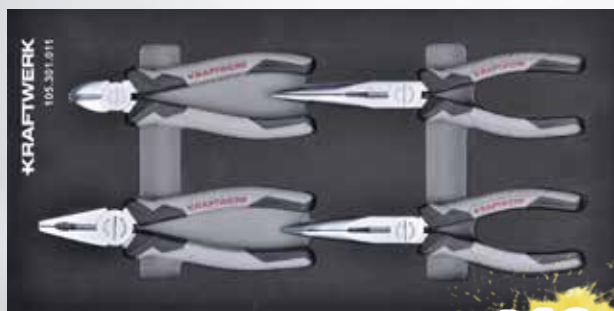

200 × 400 × 40 mm | Δ 2.2 kg

€119,-
~~€141,-~~

Art. 105.301.011

BASIC LINE pliers inlay, 20 × 40 cm, 4 pcs.

Diagonal cutter 160 mm
Flat round pliers curved 200 mm
Flat round pliers 200 mm
Combination pliers 180 mm



200 × 400 × 40 mm | Δ 2 kg

€78,-
~~€87,-~~

Art. 105.301.012

BASIC LINE double ended ring spanner inlay, 20 × 40 cm, 4 pcs.

Double ended ring spanners 21 × 23 24 × 27 25 × 28 30 × 33 mm
Cranked on both sides 70°
DIN 838, ISO 3318, ISO 1085, ISO 10104
Chrome vanadium



20 × 40 cm

200 × 400 × 40 mm | Δ 0.74 kg

€ 49,-
~~€ 55,-~~

Art. 105.301.013**BASIC LINE screwdriver with impact cap inlay, 20 × 40 cm, 5 pcs.**

Screwdriver with impact cap slotted: 5.5 - 8 mm
Screwdriver with impact cap PH: PH1 - PH2
Ergonomic 2-component handle

200 × 400 × 40 mm | Δ 0.7 kg

€ 89,-
~~€ 100,-~~

Art. 105.301.014**BASIC LINE file inlay, 20 × 40 cm, 6 pcs.**

Steel wire brush
Stainless steel straight ruler 30 cm
Caliper
Triangular file 200 mm / 8"
Round file 200 mm / 8"
Triangular file for brakes 150 mm / 6"

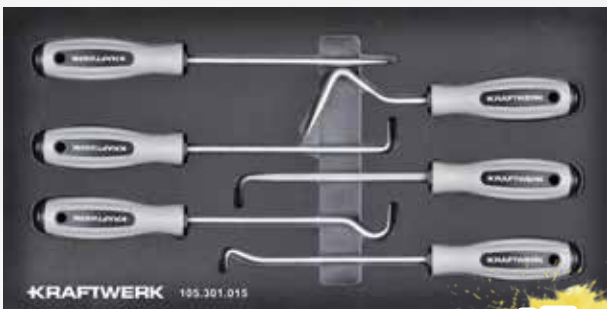
200 × 400 × 40 mm | Δ 0.72 kg

€ 45,-
~~€ 52,-~~

Art. 105.301.015**BASIC LINE trim removal tool inlay, 20 × 40 cm, 6 pcs.**

Hook tool, straight
Hook tool, 45° bent tip
Hook tool, 90° bent tip
Hook tool, sickle shape
Round hook
Ergonomic 2-component handle
For removing seals, O-rings, trim clips or paneling
For working on the interior body paneling

200 × 400 × 40 mm | Δ 0.68 kg

€ 45,-
~~€ 52,-~~

Art. 105.301.016**BASIC LINE screwdriver extra long inlay, 20 × 40 cm, 6 pcs.**

Slotted screwdrivers extra long 250 mm: 4.0 - 5.5 mm
PH screwdrivers extra long 250 mm: PH2
Hexagon screwdrivers extra long 250 mm: 3 - 6 mm
Ergonomic 2-component handle
With burnished tip
With hanging hole

20 × 40 cm



200 × 400 × 40 mm | Δ 0.68 kg



€45,-
~~€52,-~~

Art. 105.301.017

BASIC LINE screwdriver extra long inlay, 20 × 40 cm, 6 pcs.

Slotted screwdrivers extra long 250 mm: 4.0 - 6.5 mm
Hexagon screwdrivers extra long 250 mm: 3 - 5 mm
Ergonomic 2-component handle
With burnished tip
With hanging hole



200 × 400 × 40 mm | Δ 0.7 kg



€45,-
~~€52,-~~

Art. 105.301.018

BASIC LINE screwdriver extra long inlay, 20 × 40 cm, 6 pcs.

TX screwdriver extra long 250 mm: T15 - T40
Ergonomic 2-component handle
With burnished tip
With hanging hole

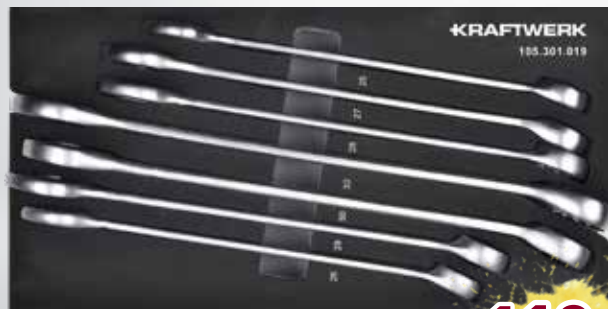

200 × 400 × 40 mm | Δ 3.55 kg



€119,-
~~€136,-~~

Art. 105.301.019

BASIC LINE combination spanner inlay, 20 × 40 cm, 7 pcs.

Combination spanners: 25 - 32 mm
Ring side angled 15°
DIN 3113 Form A, ISO 3318, ISO 7738
Chrome vanadium



200 × 400 × 40 mm | Δ 0.67 kg



€49,-
~~€56,-~~

Art. 105.301.021

BASIC LINE Hexagon L-handle ball ended key wrench inlay, 20 × 40 cm, 6 pcs.

Hexagon L-handle ball ended key wrench: 2.5 - 8 mm
Ergonomic 2-component handle

20 × 40 cm



200 × 400 × 40 mm | Δ 0.53 kg

€ 45,-
~~€ 50,-~~

**Art. 105.301.022****BASIC LINE TX L-handle key wrench inlay, 20 × 40 cm, 6 pcs.**

TX L-handle key wrench: T10 - T40
 Ergonomic 2-component handle



200 × 400 × 40 mm | Δ 1.08 kg

€ 59,-
~~€ 69,-~~

Art. 105.301.023**BASIC LINE door lining loosener inlay, 20 × 40 cm, 8 pcs.**

Large door panel remover 132 mm
 Door panel remover 110 mm
 Door panel remover small 100 mm
 Radiator hose remover
 Split pin remover
 Scraper
 Clip remover 5/16" 115 mm
 Clip remover 1/4" 115 mm

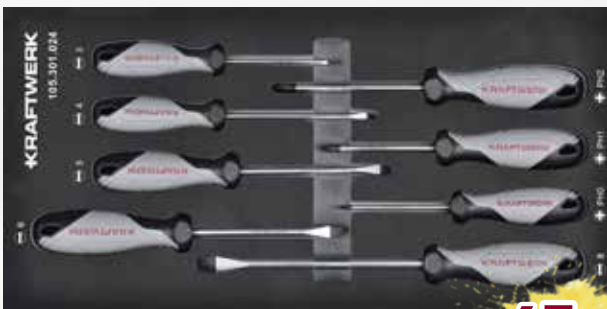

200 × 400 × 40 mm | Δ 0.68 kg

€ 45,-
~~€ 52,-~~

**Art. 105.301.024****BASIC LINE slotted screwdriver inlay, 20 × 40 cm, 8 pcs.**

Slotted screwdrivers: 3.0 - 8.0 mm
 PH screwdrivers: PH0 - PH2
 Ergonomic 2-component handle
 With burnished tip
 With hanging hole

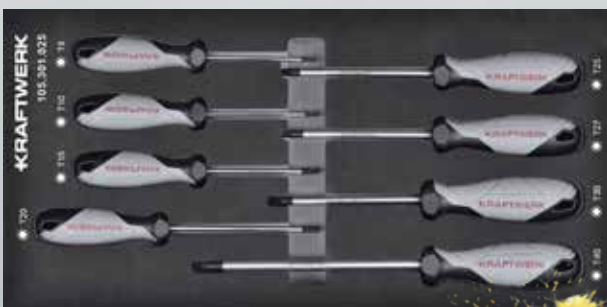

200 × 400 × 40 mm | Δ 0.7 kg

€ 39,-
~~€ 48,-~~

**Art. 105.301.025****BASIC LINE TX screwdrivers inlay, 20 × 40 cm, 8 pcs.**

TX screwdrivers: TX T8 - T40
 Ergonomic 2-component handle
 With burnished tip
 With hanging hole

20 × 40 cm



200 × 400 × 40 mm | Δ 2.85 kg

€199,-
~~€ 234,-~~



Art. 105.301.026

BASIC LINE pliers inlay, 20 × 40 cm, 8 pcs.

- Circlip pliers, straight, closing, for inner rings
- Circlip pliers, angled 90°, opening, for outer rings
- Diagonal cutter 160 mm
- Flat round pliers curved 200 mm
- Flat round pliers 200 mm
- Combination pliers 180 mm



200 × 400 × 40 mm | Δ 0.86 kg

€89,-
~~€ 104,-~~



Art. 105.301.027

BASIC LINE Hexagon T-Handle inlay, 20 × 40 cm, 9 pcs.

- Hexagon T-Handle: 2 - 8 mm
- Extra long version
- Chrome vanadium



200 × 400 × 40 mm | Δ 0.86 kg

€99,-
~~€ 121,-~~



Art. 105.301.028

BASIC LINE TX T-handle inlay, 20 × 40 cm, 9 pcs.

- TX T-handle: T10 - T50
- Extra long version
- Chrome vanadium



200 × 400 × 40 mm | Δ 1.75 kg

€69,-
~~€ 83,-~~



Art. 105.301.029

BASIC LINE double open wrench inlay, 20 × 40 cm, 10 pcs.

- Double open wrench: 6 - 32 mm
- 15° jaw position
- DIN 3110 form A, ISO 3318, ISO 7738
- Chrome vanadium

20 × 40 cm

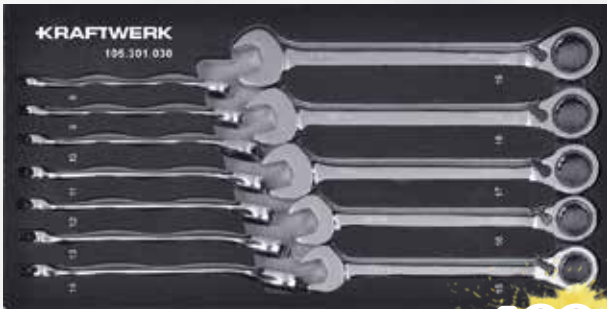

200 × 400 × 40 mm | Δ 1.63 kg



€ 198,-
~~€ 220,-~~

Art. 105.301.030**BASIC LINE ratcheting combination wrenches inlay, 40 × 20 cm, 12 pcs.**

Ratcheting combination wrenches: 8 - 19 mm
 High quality 72 tooth ratchet mechanism
 15° jaw position
 Switch lever for right and left rotation
 5° reset angle
 Chrome vanadium



200 × 400 × 40 mm | Δ 1.69 kg



€ 229,-
~~€ 262,-~~

Art. 105.301.031**BASIC LINE universal joint ratcheting combination wrenches inlay, 40 × 20 cm, 12 pcs.**

Universal joint ratcheting combination wrenches: 8 - 19 mm
 180° tiltable ratchet head
 Joint tension adjustable with screw
 72 tooth ratchet system
 5° return angle
 Ring side with joint
 Chrome vanadium



200 × 400 × 40 mm | Δ 2.33 kg



€ 109,-
~~€ 129,-~~

Art. 105.301.032**BASIC LINE combination spanner inlay, 20 × 40 cm, 19 pcs.**

Combination spanners: 6 - 24 mm
 Ring side angled 15°
 15° jaw position
 DIN 3113 form A, ISO 3318, ISO 7738
 Chrome vanadium

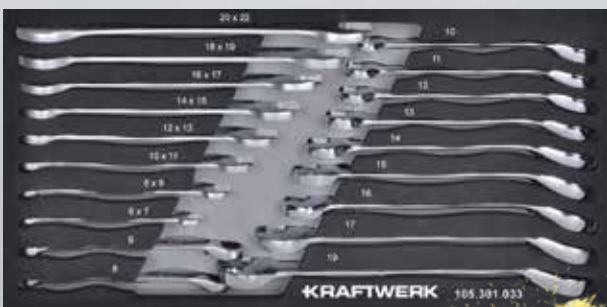

200 × 400 × 40 mm | Δ 2.19 kg

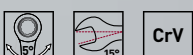

€ 199,-
~~€ 241,-~~

Art. 105.301.033**BASIC LINE ratcheting combination wrenches inlay, 20 × 40 cm, 19 pcs.**

Ratcheting combination wrenches: 8 - 19 mm
 Double open wrench: 6 - 22 mm
 Chrome vanadium

20 × 40 cm



200 × 400 × 40 mm | Δ 1.89 kg

€ 149,-
€ 167,-



Art. 105.301.034

BASIC LINE 1/4" + 1/2" socket inlay, 20 × 40 cm, 40 pcs.

- 1/4" + 1/2" ratchets
- 1/4" 50 and 100 mm extensions
- 1/2" 150 and 200 mm extensions
- 1/4" sockets 4 - 13 mm
- 1/2" sockets 10 - 32 mm
- 1/4" + 1/2" universal joint
- For manual operation
- Chrome vanadium



200 × 400 × 40 mm | Δ 1.48 kg

€ 89,-
€ 104,-



Art. 105.301.035

BASIC LINE 1/4" socket inlay, 20 × 40 cm, 61 pcs.

- 1/4" ratchets with 50, 100 and 150 mm extensions
- 1/4" sockets 5 - 13 mm
- 1/4" outside TX sockets: E-TX E4 - E10
- 1/4" Hexagon sockets: 3 - 8 mm
- 1/4" TX sockets: TX T6 - T40
- 1/4" TX sockets: TXR TR6 - TR40
- 1/4" PH sockets: PH1 - PH2
- 1/4" universal joint
- For manual operation
- Chrome vanadium



200 × 400 × 40 mm | Δ 2.3 kg

€ 119,-
€ 136,-



Art. 105.301.036

BASIC LINE 3/8" socket inlay, 20 × 40 cm, 40 pcs.

- 3/8" ratchets with 44, 75 and 150 mm extensions
- 3/8" sockets 8 - 19 mm
- 3/8" outside TX sockets: E-TX E7 - E14
- 3/8" Hexagon sockets: 6 - 12 mm
- 3/8" TX sockets: TX T25 - T50
- 3/8" universal joint
- 3/8" spark plug socket 14 - 21 mm
- For manual operation
- Chrome vanadium



60 × 40 cm



600 × 400 × 40 mm | Δ 6.115 kg



€ 159,-
~~€ 222,-~~

Art. 105.102.011**BASIC LINE socket set inlay, 1/4" + 3/8" + 1/2", 60 × 40 cm, 86 pcs.**

1/4" + 3/8" + 1/2" ratchets
 1/4" sockets: 4 - 14 mm
 1/4" deep sockets: 4 - 10 mm
 1/4" extensions: 50 + 100 mm
 3/8" sockets: 10 - 24 mm
 3/8" deep sockets: 10 - 19 mm
 3/8" extensions: 75 + 150 mm
 1/2" sockets: 14 - 32 mm
 1/2" extensions: 125 + 250 mm
 1/4" + 3/8" + 1/2" universal joint
 3/8" spark plug sockets: 16 + 21 mm
 Various adapters
 1/4" screwdriver-Bits
 Flashlight
 For manual operation
 Chrome vanadium



600 × 400 × 40 mm | Δ 4.75 kg



€ 149,-
~~€ 222,-~~

Art. 105.102.012**BASIC Line combination / double ended ring spanners and L-key wrenches inlay, 60 × 40 cm, 46 pcs.**

Combination spanners: 5.5 - 24 mm
 Double ended ring spanners: 6 × 7 - 20 × 22 mm
 Ball point Hexagon L-key wrenches: 1.5-10 mm, 9 pcs.
 TX L-key wrenches: T10-T50, 9 pcs.

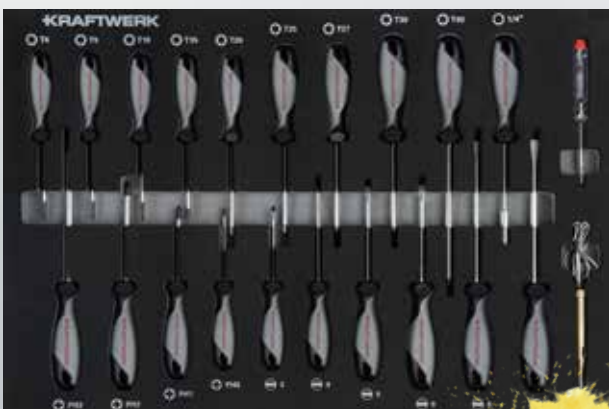

600 × 400 × 40 mm | Δ 2.03 kg



€ 99,-
~~€ 127,-~~

Art. 105.102.013**BASIC LINE screwdriver inlay, 60 × 40 cm, 22 pcs.**

Slotted screwdriver: 3 - 8 mm
 PH screwdriver PH0 - PH3
 TX screwdriver: T8 - T40
 Phase tester 110-250 V GS-tested
 Phase tester 12 V GS-tested
 Screwdrivers with ergonomic 2-component handle

60 × 40 cm



600 × 400 × 40 mm | Δ 3.47 kg

€ 159,-
€ 198,-



Art. 105.102.014

BASIC LINE pliers / measuring inlay, 60 × 40 cm, 13 pcs.

- Pressing plier for terminals, 1,5 - 6 mm²
- Combination plier: 180 mm / 7"
- Diagonal cutter: 160 mm / 6.1/2"
- Flat nose plier: 200 mm / 8"
- Water pump plier: 250 mm / 10"
- Grip plier: 250 mm / 10"
- Circlip pliers: A2, A21, J2, J21
- Steel tape measure 5 m
- Caliper gauge, 150 mm / 0.05 mm x 1/128"
- Universal scissors, 150 mm



600 × 400 × 40 mm | Δ 4.81 kg

€ 159,-
€ 210,-



Art. 105.102.015

BASIC LINE socket wrench inlay, 1/4" + 3/8" + 1/2", 60 × 40 cm, 107 pcs.

- 1/4" outside TX sockets: TX E4 - E10
- 3/8" outside TX sockets: TX E10 - E24
- 1/2" outside TX sockets: TX E10 - E20
- 1/2" TX screwdriver Bit sockets: T30 - T60
- 1/2" TX screwdriver Bit sockets, 100 mm: T30 - T55
- 1/2" Hexagon screwdriver Bit sockets: 5 - 10 mm
- 1/2" Hexagon screwdriver Bit sockets, 100 mm: 6 - 12 mm
- 1/2" XZN screwdriver Bit sockets: M5 - M12
- 1/2" XZN screwdriver Bit sockets, 100 mm: M5 - M10
- 5/16" Slotted screwdriver Bits: 8 - 12 mm
- 5/16" PH screwdriver Bit: PH-PH4
- 5/16" PZ screwdriver Bit: PZ PZ4
- 5/16" XZN screwdriver Bits: M5 - M12
- 5/16" TX screwdriver Bits: T45 - T80
- TX screwdriver Bits with hole, TT45 - TT70
- 5/16" Hexagon screwdriver Bits 8 - 14 mm
- 1/4" slotted screwdriver Bit sockets: 4 - 6.5 mm
- 1/4" PH screwdriver Bit sockets: PH1 - PH3
- 1/4" PZ screwdriver Bit sockets: PZ1 - PZ3
- 1/4" TX screwdriver Bit sockets: T8 - T40
- 1/4" Hexagon screwdriver Bit socket: 3 - 8 mm
- 1/4" TX screwdriver Bit sockets with hole: TT10 - TT40
- For manual operation
- Chrome vanadium



60 x 40 cm



600 x 400 x 40 mm | Δ 3.59 kg

€ 99,-
~~€ 148,-~~

Art. 105.102.016

BASIC LINE EVA striking / cutting tool and file inlay, 60x40 cm, 27 pcs.

- Flat chisel 18 mm
- Flat chisel 22 mm
- Center punch: 2 x 120 mm
- Pin punch 2mm x 115 mm - 8 mm x 180 mm
- Professional hacksaw: 300 mm
- File
- Half-round file
- Round file
- Triangular file
- Snap-off knife: 18 mm (with 5 spare blades)
- Spare blades set, 18 mm: 10 pcs.
- German engineer hammer, hickory: 300 g
- Plastic hammer 35 mm



600 x 400 x 40 mm | Δ 5.375 kg

€ 149,-
~~€ 203,-~~

Art. 105.102.017

BASIC LINE socket set inlay, 1/4 + 1/2", 60 x 40 cm, 164 pcs.

- 1/4" + 1/2" reversible ratchets
- 1/4" sockets: 4 - 14 mm
- 1/4" deep sockets: 6 - 13 mm
- 1/4" extensions: 50 + 100 mm
- 1/2" sockets : 10 - 32 mm
- 1/2" extensions: 125 + 250 mm
- 1/4" slotted screwdriver Bits: 4.0 - 8 mm
- 1/4" PH screwdriver Bits: PH0 - PH4
- 1/4" PZ screwdriver Bits: PZ1 - PZ4
- 1/4" TX screwdriver Bits: T8 - T40
- 1/4" Hexagon screwdriver Bits: 3 - 8 mm
- 1/4" XZN screwdriver Bits: M5 - M8
- 1/4" square screwdriver Bits: 25 mm R1 - R2
- 5/16" slotted screwdriver Bits: 10 - 12 mm
- 5/16" TX screwdriver Bits: T45 - T60
- 5/16" TX screwdriver Bits with hole: T45 - T60
- 1/4" + 1/2" universal joint
- 1/2" spark plug sockets: 16 + 21 mm
- Various adapters
- For manual operation
- Chrome vanadium
- Prepared for torque wrench 3235



60 × 40 cm



600 × 400 × 40 mm | Δ 2.41 kg



€ 139,-
~~€ 179,-~~

Art. 105.102.018

BASIC LINE screwdriver / striking tool inlay, 60 × 40 cm, 49 pcs.

- Micro Bit box, 29 pcs.
- Needle file set, 6 pcs.
- LED alu flashlight (excl. 3 × AAA)
- Slotted screwdriver 3.5 - 8 mm
- Stubby slotted screwdriver 6.5 mm
- PH screwdriver PH1 - PH2
- Stubby PH screwdriver PH2
- Phase tester 110-250 V GS approved
- German engineer hammer, hickory: 300 g
- Plastic hammer 35 mm
- Flat file



600 × 400 × 40 mm | Δ 3.68 kg

€ 139,-
~~€ 168,-~~

Art. 105.102.019

BASIC LINE combination spanner/ punch/ cutting tool inlay, 60 × 40 cm, 46 pcs.

- Combination spanner 6 - 22 mm
- Professional hacksaw: 300 mm
- Knife: 9 mm
- Knife: 18 mm
- Spare blade set, 9 mm, 10 pcs.
- Spare blade set, 18 mm, 10 pcs.
- Pin punch: 2 mm x 115 mm - 8 mm x 180 mm
- Centre punch: 2 x 120 mm
- Flat chisel: 18 + 22 mm



600 × 400 × 40 mm | Δ 3.3 kg



€ 99,-
~~€ 119,-~~

Art. 105.102.110

BASIC LINE pliers and L-key inlay, 60 × 40 cm, 78 pcs.

- Circlip pliers: A2, A21, J2, J21
- Terminal assortments
- Pressing plier for terminals, 1,5 - 6 mm³
- Combination plier: 180 mm / 7"
- Diagonal cutter: 160 mm / 6.1/2"
- Flat nose plier: 200 mm / 8"
- Water pump plier: 250 mm / 10"
- Universal scissors 185 mm
- Ball point Hexagon L-key wrenches: 1.5 - 10 mm, 9 pcs.
- TX L-key wrenches: T10 - T50, 9 pcs.



Art. 105.102.099

BASIC LINE tool assortment, 301 pcs.

Generous workshop equipment with 301 tools
 Embedded in 6 special high density soft foam trays (EVA)
 Combination wrenches from 5.5 - 24 mm
 Ratchets 1/4"+3/8"+1/2"
 1/4" Sockets: 4 - 14 mm
 3/8" Sockets: 10 - 24 mm
 1/2" Sockets: 14 - 32 mm
 Pliers / measuring tool
 Striking-/cutting tool and file
 1/4"+1/2" Slotted, PH, PZ, TX, XZN and Hexagon screwdriver Bit socket
 1/4"+3/8"+1/2" outside TX sockets
 5/16" Slotted, PH, PZ, TX, TX with hole, XZN, Hexagon screwdriver Bit

€ 889,-
~~€ 1.150,-~~



Art. 105.103.001

BASIC LINE tool assortment, 337 pcs.

Embedded in 4 special high density soft foam trays (EVA)
 Combination spanners: 6 - 22 mm
 Ratchets 1/4" + 1/2"
 1/4" sockets: 4 - 14 mm
 1/2" sockets: 10 - 32 mm
 Optional Art.-No. 3235 torque wrench, 1/2", 40-200 Nm

€ 569,-
~~€ 678,-~~



Art. 105.103.002

BASIC LINE tool assortment, 154 pcs.

Generous workshop equipment with 154 tools
 Embedded in 3 special high density soft foam trays (EVA)
 Combination wrenches from 5.5 - 24 mm
 Ratchets 1/4"+3/8"+1/2"
 1/4" sockets: 4 - 14 mm
 3/8" sockets: 10 - 24 mm
 1/2" sockets: 14 - 32 mm
 Slotted screwdriver: 3 - 8 mm
 PH screwdriver: PH0 - PH3
 TX screwdriver: T8 - T40

€ 449,-
~~€ 582,-~~



Art. 105.103.003

BASIC LINE Tool Assortment, 147 pcs.

Generous workshop equipment with 147 tools
 Embedded in 3 special high density soft foam trays (EVA)
 Pliers / measuring Tools
 Striking / cutting tool and file
 1/4"+1/2" slotted, PH, PZ, TX, XZN and Hexagon screwdriver Bit socket
 1/4"+3/8"+1/2" outside TX sockets
 5/16" Slotted, PH, PZ, TX, TX with hole, XZN, Hexagon screwdriver Bit

€ 439,-
~~€ 572,-~~

20 x 40 cm

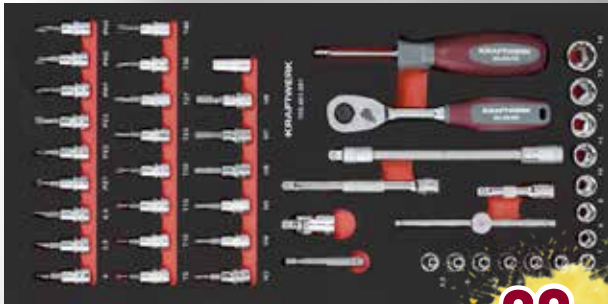

200 x 400 x 40 mm | Δ 1.2 kg

€ 99,-
~~€ 122,-~~



Art. 105.401.001

PRO LINE EVA 1/4" socket inlay, 20x40 cm, 46 pcs.

- 1/4" ratchets and extensions: 50, 100 and 150 mm
- 1/4" sockets: 3.5 - 14 mm
- 1/4" Slotted screwdriver Bit sockets: 4 - 5.5 - 6.5 mm
- 1/4" PH screwdriver Bit sockets: PH1 - PH2 - PH3
- 1/4" PZ screwdriver Bit sockets: PZ1 - PZ2 - PZ3
- 1/4" TX screwdriver Bit sockets: T8 - T10 - T15 - T20 - T25 - T27 - T30 - T40
- 1/4" Hexagon screwdriver Bit sockets: 3 - 4 - 5 - 6 - 7 - 8 mm
- 1/4" Bit adapter
- 1/4" Universal joint
- 1/4" Sliding sliding handle adapter
- 1/4" Drive handle
- 1/4" Bit holder



200 x 400 x 40 mm | Δ 2.45 kg

€ 129,-
~~€ 144,-~~



Art. 105.401.002

PRO LINE EVA 3/8" socket inlay, 20x40 cm, 32 pcs.

- 3/8" ratchets and extensions: 75 and 250 mm
- 3/8" sockets: 8 - 24 mm
- 3/8" deep sockets: 10 - 19 mm
- 3/8" spark plug sockets: 16 and 21 mm
- 3/8" universal joint
- Sliding handle adapter 1/2" to 3/8"
- Adapter 3/8" to 1/4"
- Bit holder 1/4" to 3/8"



200 x 400 x 40 mm | Δ 3.15 kg

€ 139,-
~~€ 164,-~~



Art. 105.401.003

PRO LINE EVA 1/2" socket inlay, 20x40 cm, 22 pcs.

- 1/2" ratchet and extensions: 125 and 250 mm
- 1/2" sockets: 10 - 11 - 12 - 13 - 14 - 15 - 16 - 17 - 18 - 19 - 21 - 22 - 24 - 27 - 30 - 32 - 34 mm
- 1/2" universal universal joint
- Sliding handle adapter 3/8" to 1/2"

20 x 40 cm



200 mm x 400 mm x 40 mm | Δ 1.2 kg

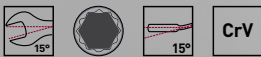

€ 69,-
~~€ 81,-~~

Art. 105.401.004

PRO LINE EVA combination spanner inlay, 20x40 cm, 12 pcs.

- Size: 8 - 19 mm
- Jaw 15° offset
- 15° angled ring side
- DIN 3113 Form A, ISO 3318, ISO 7738
- Fully polished mirror finish
- Chrome Alloy steel



200 x 400 x 40 mm | Δ 1.6 kg

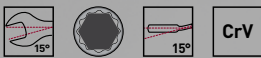

€ 79,-
~~€ 92,-~~

Art. 105.401.005

PRO LINE combination spanner inlay, 20x40 cm, 8 pcs.

- Size: 5.5 - 24 mm
- Jaw 15° offset
- 15° angled ring side
- DIN 3113 Form A, ISO 3318, ISO 7738
- Fully polished mirror finish
- Chrome Alloy Steel

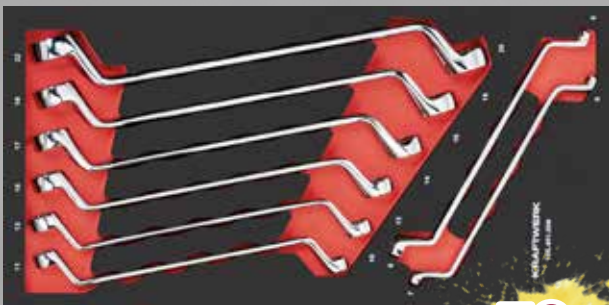

200 x 400 x 40 mm | Δ 1.5 kg



€ 79,-
~~€ 92,-~~

Art. 105.401.006

PRO LINE double ended ring spanner inlay, 20x40 cm, 8 pcs.

- Size: 6 x 7 - 8 x 9 - 10 x 11 - 12 x 13 - 14 x 15 - 16 x 17 - 18 x 19 - 20 x 22 mm
- DIN 838, ISO 3318, ISO 1085, ISO 10104
- Offset 70° on both sides
- Fully polished mirror finish
- Chrome vanadium



200 x 400 x 40 mm | Δ 1.97 kg



€ 99,-
~~€ 125,-~~

Art. 105.401.034

PRO LINE EVA "S" double open-end wrench set 20x40 10 pcs.

- Size: 6 x 7 - 8 x 9 - 1 x 11 - 12 x 13 - 14 x 15 - 16 x 17 - 18 x 19 - 21 x 22 - 24 x 27 - 30 x 32 mm
- DIN 311, ISO 3318, ISO 185, ISO 112
- Chrome Alloy Steel

20 x 40 cm

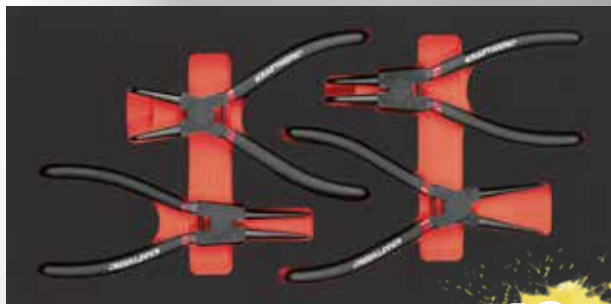

200 x 400 x 40 mm | Δ 0.62 kg



€ 69,-
~~€ 82,-~~

Art. 105.401.007

PRO LINE circlip pliers inlay, 20x40 cm, 4 pcs.

Circlip pliers, straight, closing, for inner rings
Circlip pliers, straight, opening, for inner rings
Circlip pliers, angled 90°, closing, for outer rings
Circlip pliers, angled 90°, opening, for outer rings
For circlips from Ø 19 - 60 mm



200 x 400 x 40 mm | Δ 1.8 kg

€ 65,-
~~€ 72,-~~

Art. 105.401.009

PRO LINE files inlay, 20x40 cm, 11 pcs.

Flat file, 320 mm
Half round file, 320 mm
Round file, 320 mm
Square file, 320 mm
Triangular file, 320 mm
Needle file, flat - half round - round - square - triangular - knife

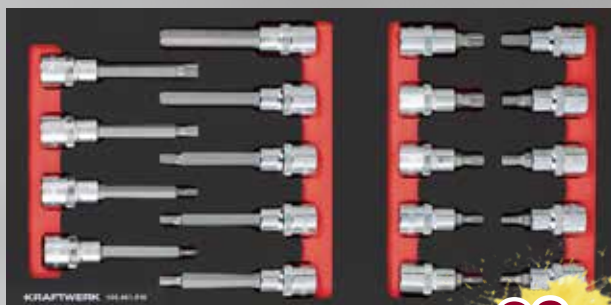

200 x 400 x 45 mm | Δ 1.94 kg



€ 89,-
~~€ 99,-~~

Art. 105.401.010

PRO LINE 1/2" socket inlay, 20x40 cm, 19 pcs.

1/2" Hexagon sockets 55 mm: 5 - 10 mm
1/2" Multi-tooth sockets 55 mm: M5 - M12
1/2" Hexagon sockets 100 mm: 6 - 12 mm
1/2" Multi-tooth sockets 100 mm: M5 - M10

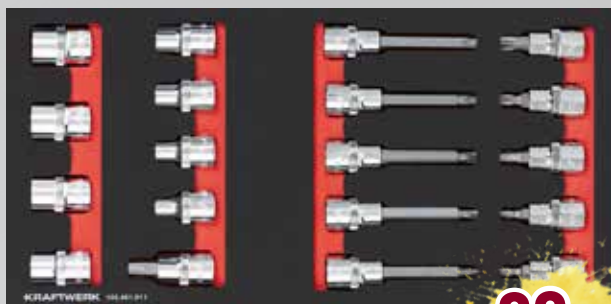

200 x 400 x 45 mm | Δ 1.94 kg



€ 89,-
~~€ 99,-~~

Art. 105.401.011

PRO LINE 1/2" socket inlay, 20x40 cm, 19 pcs.

1/2" TX sockets E-TX: E10 - E12 - E14 - E16 - E18 - E20 - E22 - E24
1/2" TX sockets 55 mm: TX T30 - T40 - T45 - T50 - T55 - T60
1/2" TX sockets 100 mm: TX T30 - T40 - T45 - T50 - T55



20 x 40 cm

NEW PRODUCT



200 x 400 x 45 mm | Δ 1.1 kg



€79,-
~~€94,-~~

Art. 105.401.012

PRO LINE screwdriver set slot PH 20x40 inlay 8 pcs.

MADE IN GERMANY

PRO LINE slotted screwdriver 4 - 8 mm
PRO LINE PH screwdriver PH: PH1 - PH2

Three component handle

Smooth, seamless handle for maximum confort

Handle with anti-roll design

Hole on screwdriver head

Screw symbols on the handle cap

Precision tip guarantees high fitting accuracy and durability equipped with high quality magnets

Continuous hard core on handle

Blade made of special chrome vanadium alloy

Above DIN/ISO requirements

Optimal power transmission

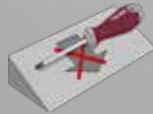

BTG
Back to Germany

NEW PRODUCT

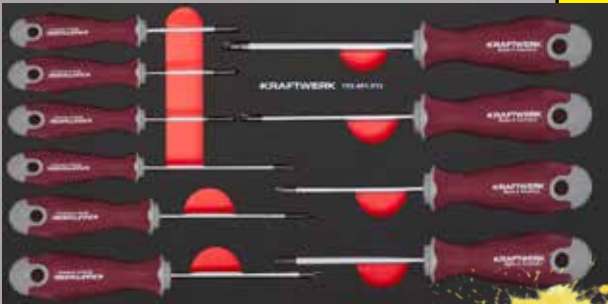

200 x 400 x 45 mm | Δ 1.1 kg



€99,-
~~€119,-~~

Art. 105.401.013

PRO LINE screwdriver set TX 20x40 inlay 10 pcs.

MADE IN GERMANY

PRO LINE TX screwdriver TX7 - TX40

Three component handle

Smooth, seamless handle for maximum confort

Handle with anti-roll design

Hole on screwdriver head

Screw symbols on the handle cap

Precision tip guarantees high fitting accuracy and durability equipped with high quality magnets

Continuous hard core on handle

Blade made of special chrome vanadium alloy

Above DIN/ISO requirements

Optimal power transmission

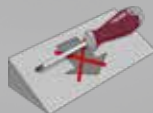

BTG
Back to Germany



20 × 40 cm



200 × 400 × 40 mm | Δ 2.16 kg

€ 99,-
€ 115,-

Art. 105.401.015

PRO LINE striking tool inlay, 20 × 40 cm, 11 pcs.

German engineer hammer, hickory: 500 g
Soft face hammer, hickory, 35 mm PU - nylon inlays: 360 g
Flat chisel, 18 - 22 mm
Pin punches, 2 - 3 - 4 - 5 - 6 - 8 mm
Center punch: No. 2



200 × 400 × 40 mm | Δ 1.08 kg

€ 49,-
€ 56,-

Art. 105.401.016

PRO LINE cutting tool inlay, 20 × 40 cm, 21 pcs.

Snap-off knife, 9 mm
Replacement blades, (10-pcs) 9 mm
Snap-off knife, 18 mm
Replacement blades, (5-pcs) 18 mm
Professional hacksaw, 300 mm



200 × 400 × 40 mm | Δ 1.5 kg

€ 119,-
€ 132,-

Art. 105.401.017

PRO LINER plier inlay 20 × 40 4 pcs.

Combination plier: 180 mm / 7"
Diagonal cutter, 160 mm / 6.1/4"
Flat round plier: 205 mm / 8"
Water pump plier: 240 mm / 9.1/2"



200 × 400 × 40 mm | Δ 1.2 kg

€ 179,-
€ 207,-

Art. 105.401.018

PRO LINE ratcheting combination wrenches inlay, 20 × 40 cm, 12 pcs.

Ratcheting combination wrenches, 72 teeth, 8 - 18 mm
Ratcheting combination wrench, 75 teeth, 19 mm
Ratcheting angle 5°
Straight version
15° jaw position
Bright chrome plated
Chrome vanadium
DIN 3113/ISO 3319

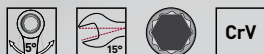

20 × 40 cm



200 × 400 × 40 mm | Δ 1.55 kg

€ 69,-
~~€ 83,-~~

Art. 105.401.023

PRO LINE Locking pliers/sheet metal shears inlay, 20 × 40 cm, 4 pcs.

- Sheet metal shears, 250 mm/ 10"
- Locking pliers, 175 mm/ 7"
- Locking pliers, 250 mm/ 10"
- Vise grip, 150 mm/ 6"



200 × 400 × 40 mm | Δ 1.18 kg

€ 88,-
~~€ 98,-~~

Art. 105.401.026

PRO LINE plier/shear inlay, 20 × 40 cm, 4 pcs.

- Pincers, 200 mm
- Cable stripper, 160 mm
- Cable stripper and crimping pliers Ergokraft
- Universal shears 150 mm



200 × 400 × 78 mm | Δ 3.99 kg

€ 359,-
~~€ 399,-~~

Art. 105.401.027

PRO LINE 1/2" impact wrench inlay, 20 × 40 cm, 17 pcs.

- Impact wrench, 920 Nm
- Impact sockets: 10 - 24 mm
- Impact sockets, for rims, 17 - 19 - 21 - 22 - 24 mm
- Extension, 125 mm
- CrMo



200 × 400 × 60 mm | Δ 2.8 kg

€ 119,-
~~€ 135,-~~

Art. 105.401.028

PRO LINE EVA 1/2" impact socket inlay 20 × 40 cm, 20 pcs.

- 1/2" impact sockets: 10 - 36 mm
- 1/2" impact extension: 125 mm



20 x 40 cm



200 x 400 x 67 mm | Δ 4.26 kg

€ 149,-
€ 176,-



Art. 105.401.029

PRO LINE EVA 1/2" impact socket inlay, 20x40 cm, 15 pcs.

1/2" deep impact sockets: 13 - 36 mm

1/2" impact extension: 125 mm



200 x 400 x 40 mm | Δ 0.83 kg

€ 79,-
€ 89,-



Art. 105.401.031

PRO LINE EVA T-handle screwdriver hexagon socket inlay, 20x40 cm, 7 pcs.

Hexagon ballpoint T-handle screwdriver

Width across flats: 3 - 10 mm

With ergonomic 2-component handle



200 x 400 x 40 mm | Δ 3.233 kg

€ 179,-
€ 210,-



Art. 105.401.032

PRO LINE EVA 1/2" socket wrench inlay, 20x40 cm, 33 pcs.

Short version 55 mm

Hexagon socket: 5 - 6 - 7 - 8 - 10 - 12 mm

Socket TX: T30 - T40 - T45 - T50 - T55 - T60

Socket multi-tooth: M5 - M6 - M8 - M10 - M12 - M14

Long version 100 mm

Hexagon socket: 6 - 7 - 8 - 10 - 12 mm

Socket TX: T30 - T40 - T45 - T50 - T55

Socket multi-tooth: M5 - M6 - M8 - M10 - M13

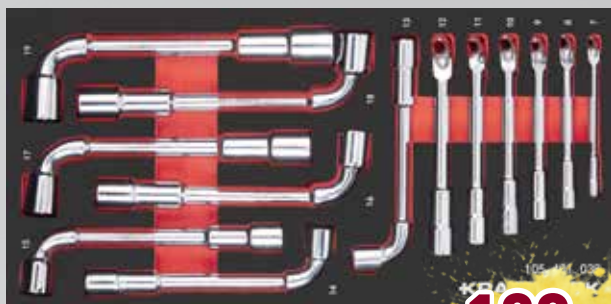

200 x 400 x 40 mm | Δ 2.613 kg

€ 129,-
€ 153,-



Art. 105.401.038

PRO LINE EVA pipe head wrench 20x40 cm, 13 pcs.

Elbow milled open wrench, double-hex x hex

7 - 8 - 9 - 10 - 11 - 12 - 13 - 14 - 15 - 16 - 17 - 18 - 19 mm

20 x 40 cm

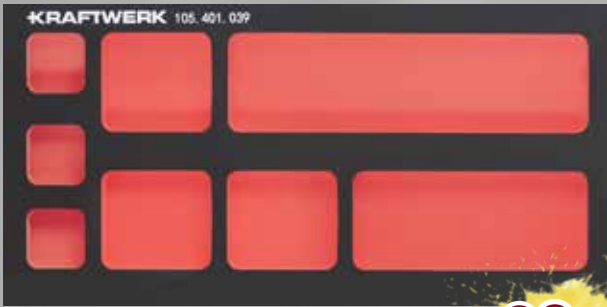

200 x 400 x 40 mm | Δ 0.18 kg

€ 29,-
€ 36,-

Art. 105.401.039

PRO LINE EVA small parts inlay, 20x40 cm
8 Subdivisions



200 x 400 x 40 mm | Δ 2.466 kg

€ 289,-
€ 330,-



Art. 105.401.041

PRO LINE EVA ratchet combination wrench inlay, 20x40 cm, 14 pcs.

Width wrench: 8 - 9 - 10 - 11 - 12 - 13 - 14 - 15 - 16 - 17 - 18 - 19 - 22 - 24 mm
Switch lever for right and left rotation
High quality 72 tooth ratchet mechanism
5° return angle
Straight design
15° jaw position
Bright chrome plated
Chrome Vanadium



200 x 400 x 40 mm | Δ 0.6 kg

€ 89,-
€ 99,-



Art. 105.401.043

PRO LINE EVA T-handle screwdriver TX inlay, 20x40 cm, 7 pcs.

TX T-handle screwdriver: TX T10 - T40
With ergonomic 2 component handle



200 x 400 x 40 mm | Δ 2.8 kg

€ 179,-
€ 199,-



Art. 105.401.045

PRO LINE EVA open-ended double-ended wrench inlay, 20x40 cm, 13 pcs.

Ratchet wrench with hinge: 8 - 10 - 11 - 12 - 13 - 14 mm
Open-ended double box wrenches metric: 9 x 11 - 10 x 12 - 13 x 14 - 15 x 17 mm
Open-ended double box wrenches INCH: 3/8 "x7/16" - 1/2 "x9/16" - 5/8 "x11/16"

20 × 40 cm



200 × 400 × 40 mm | Δ 1.2 kg

**NEW
PRODUCT**

€ 159,-
~~€ 219,-~~

Art. 105.401.046

PRO LINE EVA measuring tool inlay, 10 pcs.

- Caliper 150 mm [also suitable with digital caliper Art. No. 2972]
- Steel rule 300 mm
- Feeler blade gauge 0.05-0.8 mm
- Outside micrometer 0-25 mm
- Protractor
- Flat angle
- Telescopic magnetic finder
- Rolling meter 5m
- Double meter wood



200 × 400 × 40 mm | Δ 1.73 kg

€ 129,-
~~€ 144,-~~

Art. 105.401.051

PRO LINE EVA "S" L-key wrenches inlay, 20 × 40 cm, 28 pcs.

- L-Key wrenches, 1.5 - 2 - 2.5 - 3 - 4 - 5 - 6 - 7 - 8 - 10 mm
- TX L-key wrenches, T10 - T15 - T20 - T25 - T27 - T30 - T40 - T45 - T50
- TX L-key wrenches with hole, TS10 - TS15 - TS20 - TS25 - TS27 - TS30 - TS40 - TS45 - TS50



60 x 40 cm

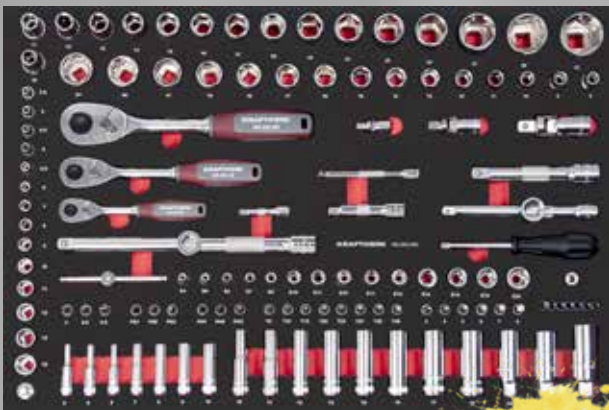

400 x 600 x 40 mm | Δ 7.2 kg

€479,-



Art. 105.502.026

PRO LINE EVA socket wrench inlay, 1/4" + 3/8" + 1/2", 60x40 cm, 125 pcs.

- Ratchet handle, 1/4"
- Sockets, 3.5 - 4 - 4.5 - 5 - 5.5 - 6 - 7 - 8 - 9 - 10 - 11 - 12 - 13 - 14 mm
- Sockets, deep, 4 - 5 - 6 - 7 - 8 - 9 - 10 mm
- Bit sockets, slotted 4 - 5.5 - 6.5 mm
- Bit sockets, PH1 - PH2 - PH3
- Bit sockets, PZ1 - PZ2 - PZ3
- Bit sockets, TX T8 - T10 - T15 - T20 - T25 - T27 - T30 - T40
- Bit sockets, TX-TR T10 - T15 - T20 - T25 - T27 - T30 - T40
- Bit sockets, hex 3 - 4 - 5 - 6 - 7 - 8 mm
- Bit sockets, E-TX E4 - E5 - E6 - E7 - E8 - E10 - E11
- Universal joint
- Extension, 50 and 100 mm
- Sliding handle with adapter
- Drive handle
- Bit adapter
- Ratchet handle, 3/8"
- Sockets, 8 - 9 - 10 - 11 - 12 - 13 - 14 - 15 - 16 - 17 - 18 - 19 - 21 - 22 - 24 mm
- Sockets, deep, 10 - 11 - 12 - 13 - 14 - 15 - 17 - 19 mm
- Sockets, E-TX E10 - E11 - E12 - E14 - E16 - E18 - E20
- Spark plug sockets, 16 - 18 - 21 mm
- Universal joint
- Extension, 75 and 250 mm
- Sliding handle adapter
- Adapter, 3/8" to 1/4"
- Ratchet handle, 1/2"
- Sockets, 10 - 11 - 12 - 13 - 14 - 15 - 16 - 17 - 18 - 19 - 21 - 22 - 24 - 27 - 30 - 32 mm
- Universal joint
- Extension, 125 and 250 mm
- Sliding handle adapter



400 x 600 x 40 mm | Δ 2.16 kg

€289,-
€325,-

Art. 105.502.027

PRO LINE EVA pliers inlay, 60x40 cm, 11 pcs.

- Pliers wrench 250mm
- Side cutting nippers 160 mm
- Lever side cut.nipper 200 mm
- Long nose pliers 205 mm
- Long nose pliers 45° 205 mm
- Circlips pliers A2
- Circlips pliers A21
- Circlips pliers J2
- Circlips pliers J21
- Wire stripping pliers 160 mm
- Combination pliers 180 mm



400 x 600 x 40 mm | Δ 7.04 kg

€529,-
€595,-



Art. 105.502.028

PRO LINE EVA wrench and torque wrench tray, 60x40 cm, 44 pcs.

- Torque wrench Ergokraft, item no. 3235, 1/2", 4-200 Nm
- Combination wrenches, 5.5 - 32 mm
- Adjustable wrench Ergokraft, 150 mm / 6"
- Adjustable wrench Ergokraft, 200 mm / 8"
- Spherical head hex keys, 1.5 - 1 mm 9 pcs.
- Key wrenches, TX T1 - T5 9 pcs.

Art. 105.503.028

PRO LINE EVA wrench tray, 60x40 cm, 43 pcs.

Without Art. 3235, torque wrench 1/2", 4 - 200 Nm

€495,-

60 × 40 cm

**NEW
PRODUCT**



Art. 105.502.030

PRO LINE EVA 3/4" socket spanner inlay 60x40 cm, 21 pcs.

3/4" extendable ratchet: 500 - 800 mm, 42 teeth

3/4" sockets: 19 - 50 mm

Optional with digital torque adapter 100-500 Nm (Art. 4081-34)

Optional with digital torque adapter 200-1000 Nm (Art. 4081-341)

€489,-
~~€549,-~~

400 × 600 × 40 mm | Δ 15 kg

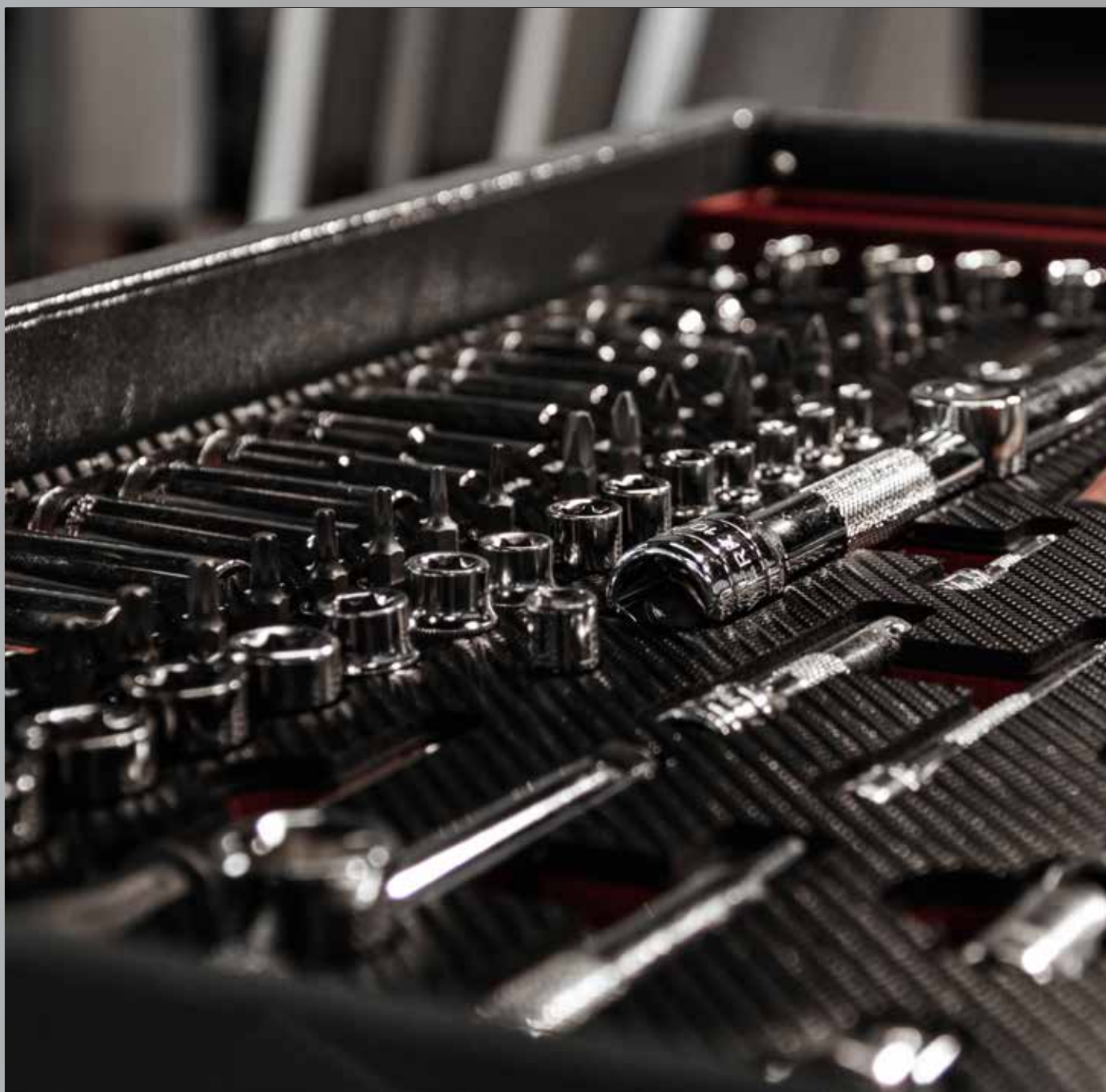





TOOL TROLLEY

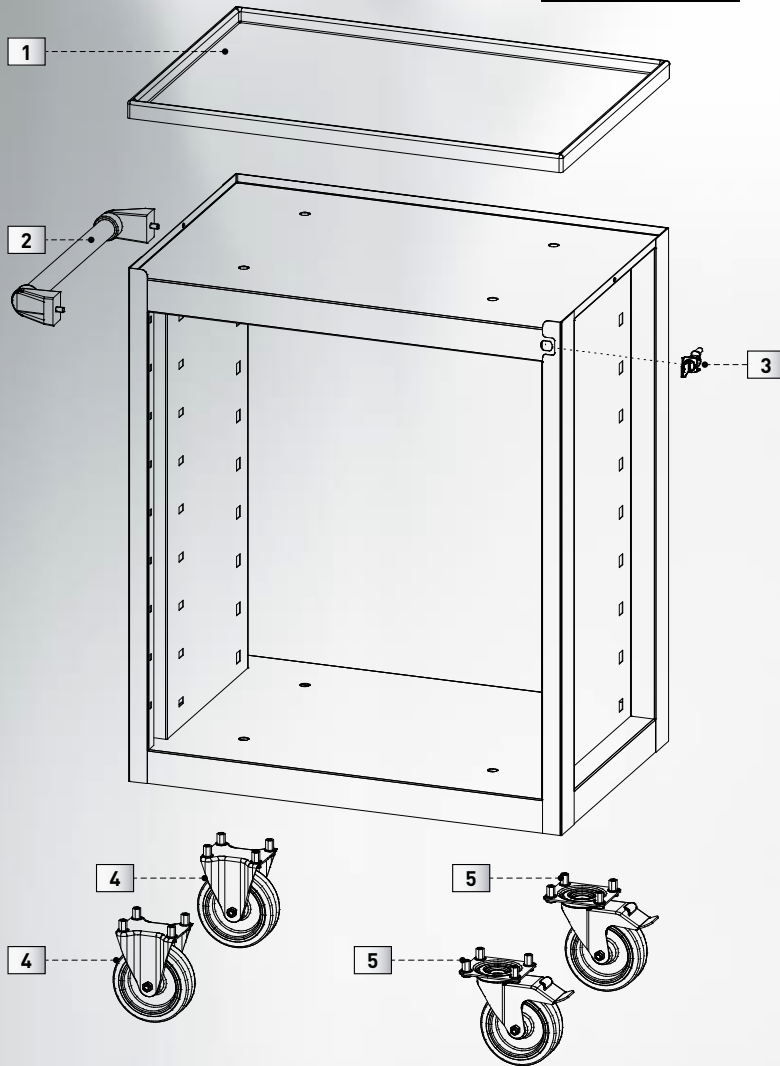

DRAWERS

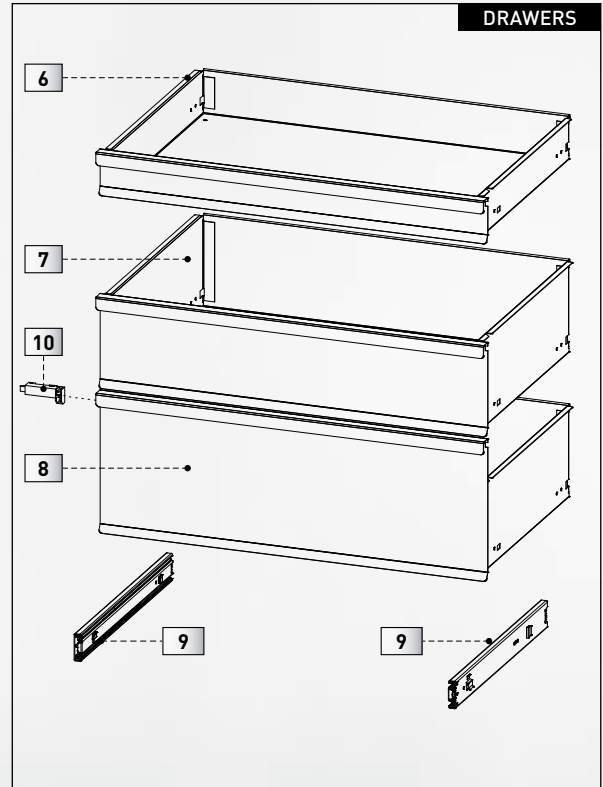

No.	Art.	Description	Pcs.	€
1	143.998.204	PS (polystyrene) cover	1	44,-
2	143.998.103	Handle for tool trolley LT700	1	25,70
3	191.504.001	Lock for Mobile Tool Cabinet BT700/BT900/BT1100	1	20,90
4	143.998.002	Rigid castor for Mobile Tool Cabinet BT700/ BT900/ BT1100	1	37,50
5	143.998.001	Swivel castor with brake for Mobile Tool Cabinet BT700/BT900/BT1100	1	45,60
6	191.503.004	Drawer workshop trolley LT700 H 75 mm without rail	1	166,97
7	191.503.005	Drawer workshop trolley LT700 150 mm without rail	1	179,90
8	191.503.006	Drawer workshop trolley LT700 225 mm	1	192,80
9	191.117.010	Rail pair for LT700/BT700s without anti-tilt function	2	12,50
10	3908-016	Plastic drawer lock	1	2,10

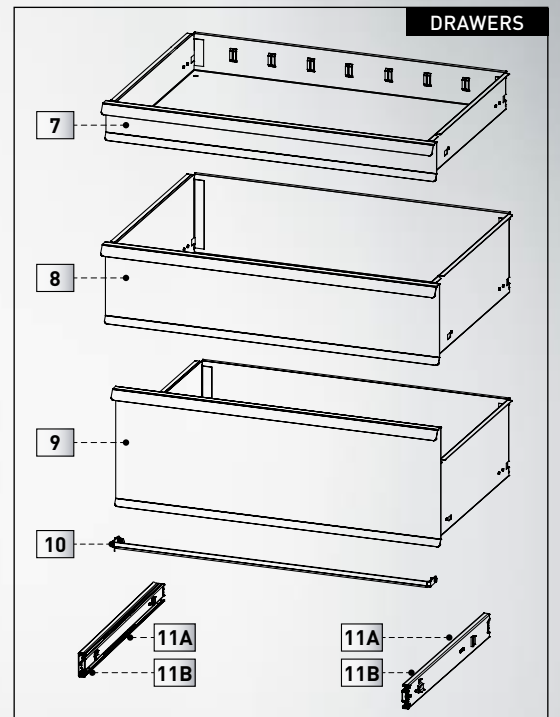
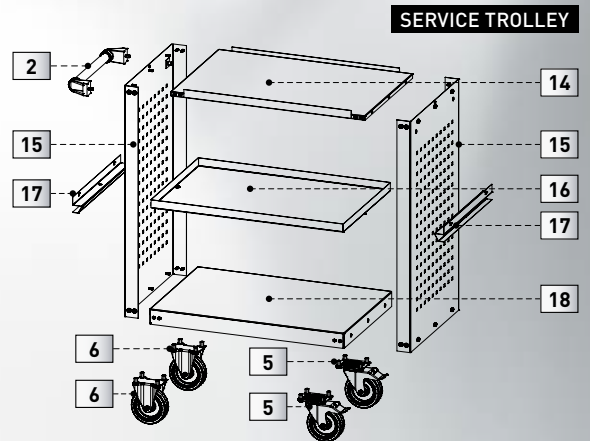
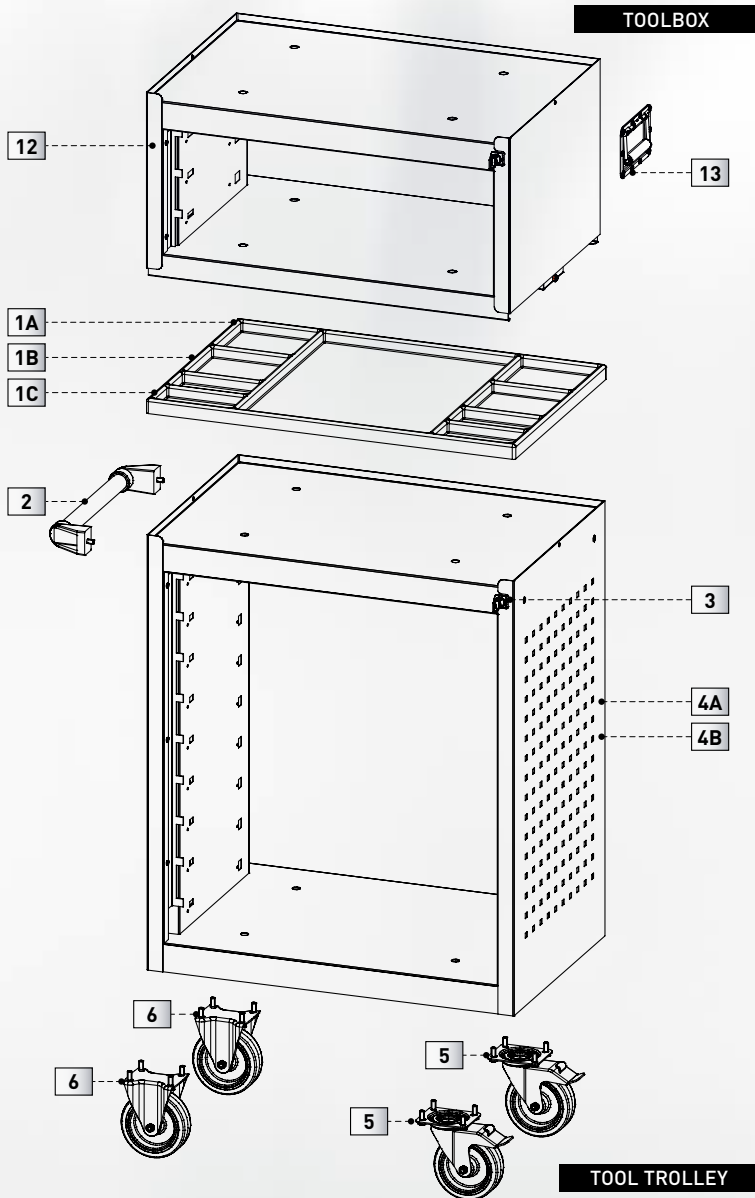

No.	Art.	Description	Pcs.	€
1A	143.998.201	PS Cover for Mobile Tool Cabinet BT700s/BT700	1	44,-
1B	191.501.001	Rubber mat for Mobile Tool Cabinet BT700s/BT700	1	33,-
1C	191.505.001	Wooden top for Mobile Tool Cabinet BT700s/BT700	1	219,-
2	143.998.101	Cabinet handle for tool trolley BT700s/BT700/BT900/BT1100	1	25,70
3	191.504.001	Lock for Mobile Tool Cabinet BT700s/BT700/BT900/BT1100	1	20,90
4A	191.502.011	Body for Mobile Tool Cabinet BT700s	1	176,57
4B	191.502.001	Body for Mobile Tool Cabinet BT700	1	188,42
5	143.998.001	Swivel castor with brake for Mobile Tool Cabinet BT700s/BT700/BT900/BT1100	1	45,60
6	143.998.002	Rigid castor for Mobile Tool Cabinet BT700s/BT700/BT900/BT1100	1	37,50
7	191.503.001	Drawer for Mobile Tool Cabinet BT700s/BT700/BT1100 75mm height	1	166,97
8	191.503.002	Drawer for Mobile Tool Cabinet BT700s/BT700/BT1100 150mm height	1	179,88
9	191.503.003	Drawer for Mobile Tool Cabinet BT700s/BT700/BT1100 225mm height	1	192,80
10	191.504.002	Unlocking bar for drawer BT700s/BT700/ BT1100	1	11,61
11A	191.117.010	Rail for BT700s without anti-tilt function	2	12,50
11B	191.117.011	Rail for BT700/BT900/BT1100 with anti-tilt function	2	25,-
12	191.507.001	Carcass to top 40x60	1	115,18
13	191.508.001	Handle to top BASIC trolley	1	33,90
14	191.507.006	Top floor for service trolley BT700	1	50,48
15	191.507.003	Side panel for service trolley BT700/ BT900	1	76,43
16	191.507.005	Middle floor for service trolley BT700	1	50,48
17	191.507.010	List for medium shelf service trolley BT700/BT900	1	33,70
18	191.507.004	Bottom shelf for service trolley BT700	1	50,48

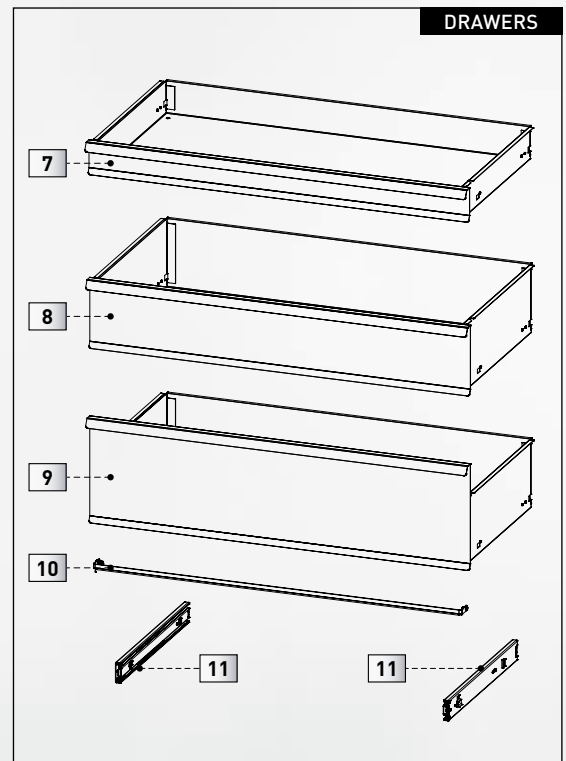
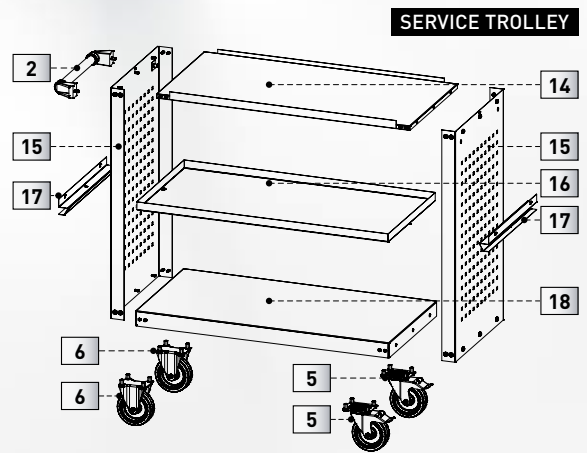
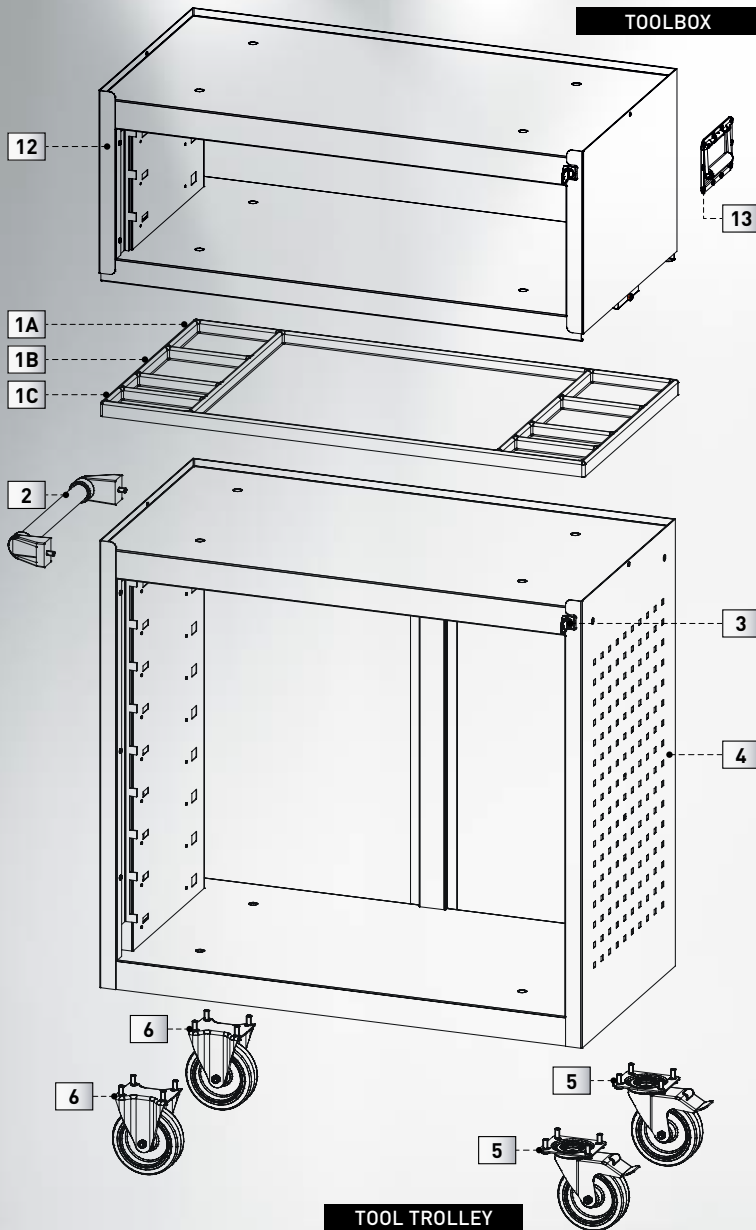

No.	Art.	Description	Pcs.	€
1A	191.117.010	PS Cover for Mobile Tool Cabinet BT900	1	12,50
1B	191.501.002	Rubber mat for Mobile Tool Cabinet BT900	1	41,-
1C	191.505.002	Wooden top for Mobile Tool Cabinet BT900	1	249,-
2	143.998.101	Cabinet handle for tool trolley BT700s/BT700/BT900/BT1100	1	25,70
3	191.504.001	Lock for Mobile Tool Cabinet BT700s/BT700/BT900/BT1100	1	20,90
4	191.502.002	Body for Mobile Tool Cabinet BT900	1	235,82
5	143.998.001	Swivel castor with brake for Mobile Tool Cabinet BT700s/BT700/BT900/BT1100	1	45,60
6	143.998.002	Rigid castor for Mobile Tool Cabinet BT700s/BT700/BT900/BT1100	1	37,50
7	191.503.011	Drawer for Mobile Tool Cabinet BT900 75 mm height	1	179,88
8	191.503.012	Drawer for Mobile Tool Cabinet BT900 150 mm height	1	192,80
9	191.503.013	Drawer for Mobile Tool Cabinet BT900 225 mm height	1	205,72
10	191.504.003	Unlocking bar for drawer BT900	1	11,60
11	191.117.011	Rail for BT700/BT900/BT1100 with anti-tilt function	2	25,-
12	191.507.002	Carcase to Top 40x80	1	128,10
13	191.508.001	Handle to top BASIC trolley	1	33,90
14	191.507.009	Top floor for service trolley BT900	1	63,40
15	191.507.003	Unlocking bar for drawer BT900	1	76,43
16	191.507.008	Middle floor for service trolley BT900	1	63,40
17	191.507.010	List for medium shelf service trolley BT700/ BT900	1	33,70
18	191.507.007	Bottom shelf for service trolley BT900	1	63,40

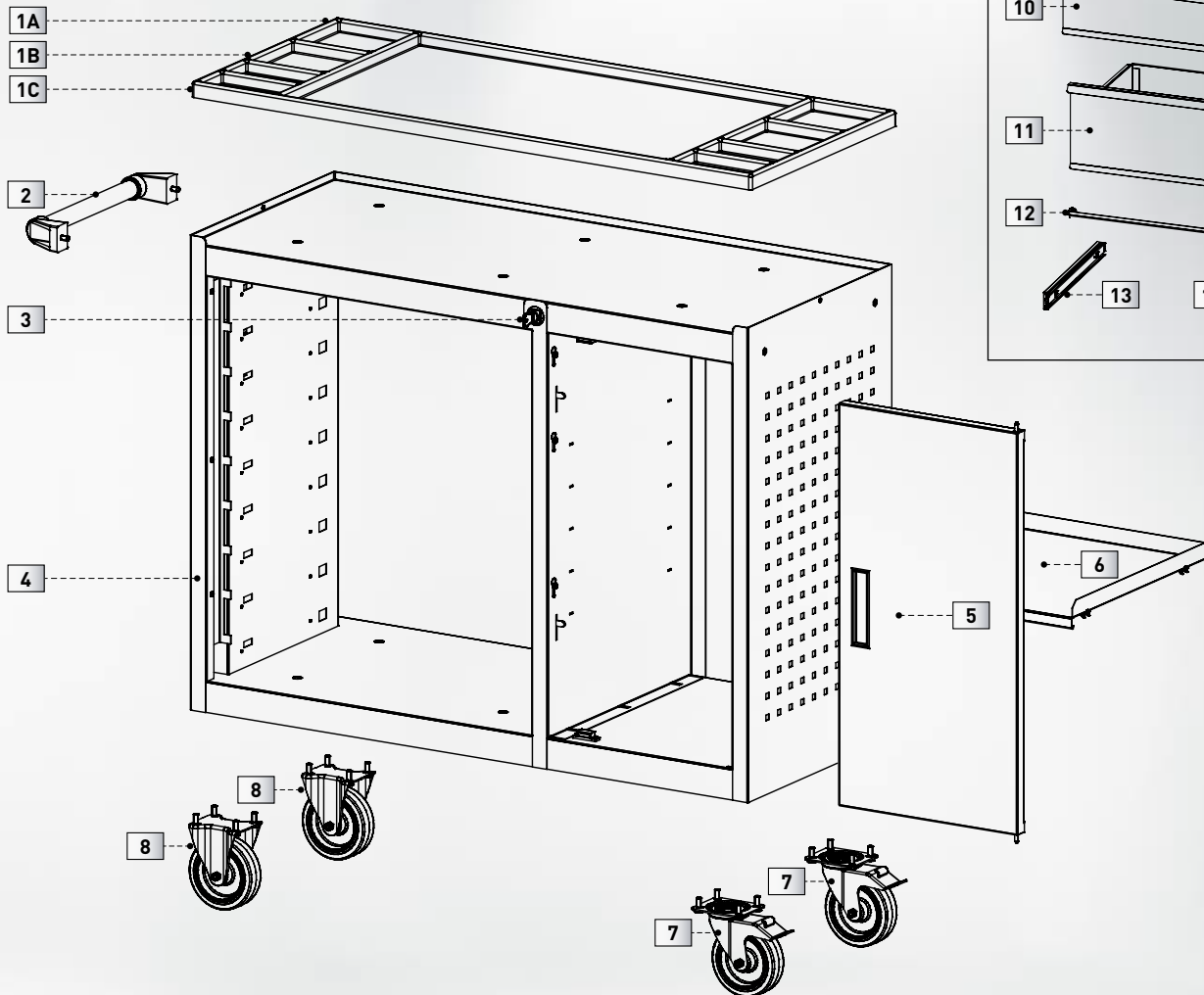
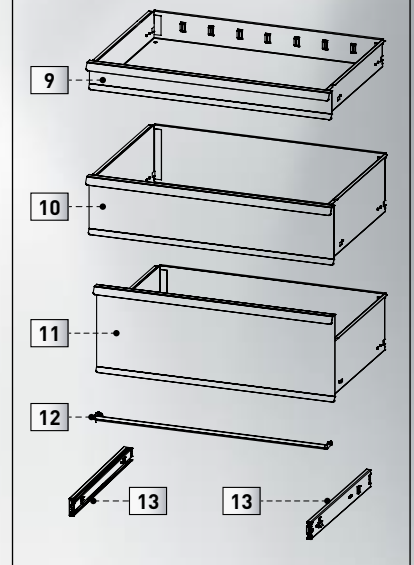
TOOL TROLLEY**DRAWERS**

No.	Art.	Description	Pcs.	€
1A	143.998.203	PS Cover for Mobile Tool Cabinet BT1100	1	62,-
1B	191.501.003	Rubber mat for Mobile Tool Cabinet BT1100	1	45,-
1C	191.505.003	Wooden top for Mobile Tool Cabinet BT1100	1	279,-
2	143.998.101	Cabinet handle for tool trolley BT700s/BT700/BT900/BT1100	1	25,70
3	191.504.001	Lock for Mobile Tool Cabinet BT700s/BT700/BT900/BT1100	1	20,90
4	191.502.003	Body for Mobile Tool Cabinet BT1100	1	283,22
5	191.506.001	Door for Mobile Tool Cabinet BT1100	1	117,32
6	191.506.011	Storage compartment for Mobile Tool Cabinet BT1100	1	50,48
7	143.998.001	Swivel castor with brake for Mobile Tool Cabinet BT700s/BT700/BT900/BT1100	1	45,60
8	143.998.002	Rigid castor for Mobile Tool Cabinet BT700s/BT700/BT900/ BT1100	1	37,50
9	191.503.001	Drawer for Mobile Tool Cabinet BT700s/BT700/BT1100 75 mm height	1	166,97
10	191.503.002	Drawer for Mobile Tool Cabinet BT700s/BT700/BT1100 150 mm height	1	179,88
11	191.503.003	Drawer for Mobile Tool Cabinet BT700s/BT700/BT1100 225 mm height	1	192,80
12	191.504.002	Unlocking bar for drawer BT700s/BT700/BT1100	1	11,61
13	191.117.011	Rail for BT700/BT900/BT1100 with anti-tilt function	2	25,-

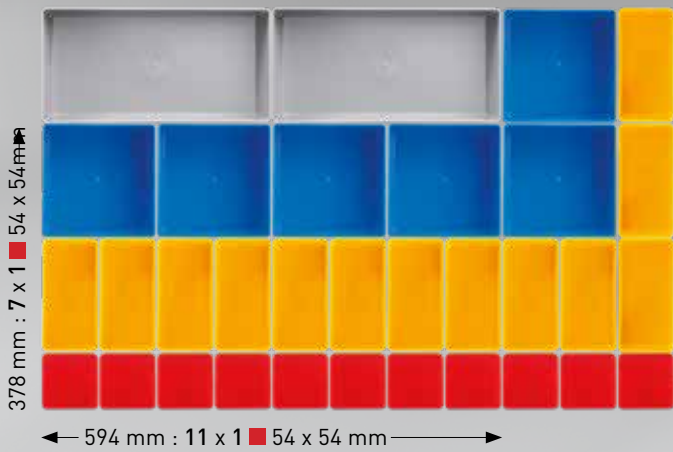
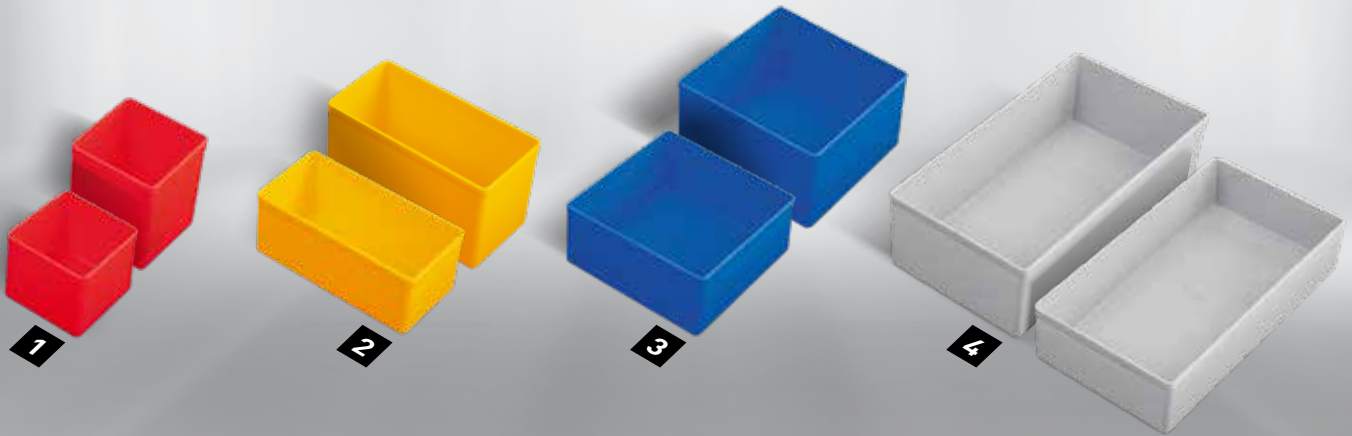

Art.	Description	€
198.000.018	inlay box No. 1-45 1 B 54 x T 54 x H 45 mm	1,10
198.000.022	inlay box No. 1-63 1 B 54 x T 54 x H 63 mm	1,40
198.000.019	inlay box No. 2-45 2 B 108 x T 54 x H 45 mm	1,50
198.000.023	inlay box No. 2-63 2 B 108 x T 54 x H 63 mm	1,90
198.000.020	inlay box No. 3-45 3 B 108 x T 108 x H 45 mm	2,30
198.000.024	inlay box No. 3-63 3 B 108 x T 108 x H 63 mm	2,80
198.000.021	inlay box No. 4-45 4 B 108 x T 216 x H 45 mm	3,40
198.000.025	inlay box No. 3-63 4 B 108 x T 216 x H 63 mm	4,60



Subject to changes of specifications, prices and availability.

Prices €
(excl. V.A.T.)

01.05.2023 - 31.01.2024
(Extension of the term possible)

Your specialized dealer: