

# KRAFTWERK®













FAVORITE TOOLS SINCE 1979

## Manual de Instruções

### Lâmpada LED IN.VIEW 250, recarrgável

Art. 32071

PT

 <b>3 h</b>	 Li-Ion 3.7 V 2600 mAh
 3 W COB LED <b>3 h</b>	 1 W SMD LED <b>10 h</b>
 3 W COB LED 250 lumen 115 Lux (1m)	 1 W SMD LED 70 lumen 165 Lux (1m)
 <b>6000 K</b>	 -10°C - 40°C
 <b>IK07</b>	 <b>110°</b>
 <b>IP20</b>	 1x3 W COB LED 2x1 W SMD LED 3x off

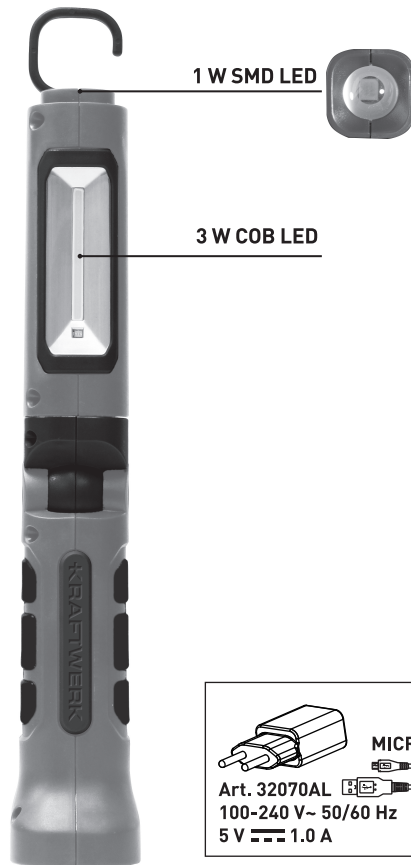

**IMPORTANT! RETAIN FOR FUTURE REFERENCE: READ CAREFULLY!**

## **TECHNICAL SPECIFICATIONS**

Artigo	32071
Classe de protecção	III
Grau de protecção	IP20
Protecção contra impactos	IK07
Tensão nominal	100-240 V~ 50/60 Hz
Tensão de saída	5 V $\text{---}$ 1 A (Max.)
LED	3 W COB, 1 W SMD
Lúmen	250 lm (3 W) , 70 lm (1 W)
Lux	115 lx (3 W / 1 m), 25 lx (1 W / 1 m)
CRI	>80
Kelvin	6000 K
Tempo de recarga	3 h
Tempo de funcionamento	3 h (3 W), 10 h (1 W)
Bateria	Li-ion 3.7 V $\text{---}$ 2600 mAh
Temperatura de operação	-10°C ~ +40°C
Dimensões	290 x 66 x 49 mm
Peso	332 g

## **PROPER INTENDED USE:**

The handlamp is suitable for indoor and outdoor lighting applications.

## **WARNING / CHARGING INSTRUCTION / BATTERY TIPS**

- Avoid looking directly into the beam of light, as this will result in dazzling.
- Do not use the lamp near a naked flame.
- Before using the lamp for the first time, the battery must be fully charged.
- Recharge frequently.
- Always replace the battery with an original battery.
- Do not leave the battery without charge for an extended period.
- Deep discharge risks damaging the battery.
- The light source of this lamp is not replaceable; when the light source reaches its end of life the whole lamp shall be replaced.

## **CLEANING**

Do not use solvents, corrosive cleaners or the like. Use a dry or slightly moist cloth for cleaning **ONLY**.



Waste electrical products should not be disposed of together with household waste. Please recycle where designated facilities exist. Check with your local authority or retailer for recycling advice.

- The battery must be removed from the appliance before it is scrapped.
- The appliance must be disconnected from the main power supply when removing the battery.
- The battery must be disposed of safely.

## **WARRANTY**

We do not take responsibility for any damage caused by misuse or any use that is not in compliance with the safety standards described herein.

## **CUSTOMER SERVICES**

Contact your local importer or your specialized dealer to obtain address of our service department.

---

**FROM DATE OF PURCHASE RECEIPT  
2 YEAR GUARANTEE  
ON MATERIAL OR PRODUCTION DEFECTS**

# **KRAFTWERK®**

FAVORITE TOOLS SINCE 1979

**KRAFTWERK Europe AG**  
Mettlenbachstrasse 23  
CH-8617 Mönchaltorf  
Switzerland  
Tel. +41-44 949 40 50

**KRAFTWERK Sàrl.**  
25, rue du Stade  
F – 67870 Bischoffsheim  
France  
Tel. +33-388 48 64 50

**[www.kraftwerktools.com](http://www.kraftwerktools.com)**