

KRAFTWERK®













FAVORITE TOOLS SINCE 1979

Instruction Manual

LED hand lamp IN.VIEW 250, rechargeable

Art. 32071

EN

 3 h	 Li-Ion 3.7 V 2600 mAh
 3 W COB LED 3 h	 1 W SMD LED 10 h
 3 W COB LED 250 lumen 115 Lux (1m)	 1 W SMD LED 70 lumen 165 Lux (1m)
 6000 K	 -10°C - 40°C
 IK07	 110°
 IP20	 1x3 W COB LED 2x1 W SMD LED 3x off

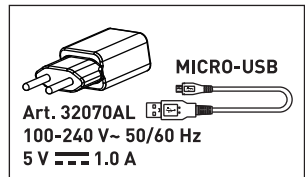
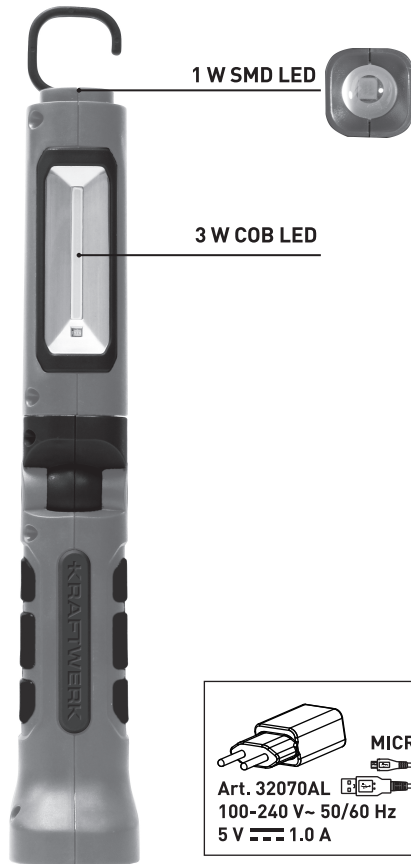

IMPORTANT! RETAIN FOR FUTURE REFERENCE: READ CAREFULLY!

TECHNICAL SPECIFICATIONS

Model	32071
Protection class	III
Protection degree	IP20
Impact protection	IK07
Nominal voltage	100-240 V~ 50/60 Hz
Output voltage	5 V $\overline{\text{---}}$ 1 A (Max.)
LED	3 W COB, 1 W SMD
Lumen	250 lm (3 W) , 70 lm (1 W)
Lux	115 lx (3 W / 1 m), 25 lx (1 W / 1 m)
CRI	>80
Kelvin	6000 K
Charging time	3 h
Operating time	3 h (3 W), 10 h (1 W)
Battery	Li-ion 3.7 V $\overline{\text{---}}$ 2600 mAh
Operating temperature	-10°C ~ +40°C
Dimensions L/B/H	290 x 66 x 49 mm
Net weight	332 g

PROPER INTENDED USE:

The handlamp is suitable for indoor and outdoor lighting applications.

WARNING / CHARGING INSTRUCTION / BATTERY TIPS

- Avoid looking directly into the beam of light, as this will result in dazzling.
- Do not use the lamp near a naked flame.
- Before using the lamp for the first time, the battery must be fully charged.
- Recharge frequently.
- Always replace the battery with an original battery.
- Do not leave the battery without charge for an extended period.
- Deep discharge risks damaging the battery.
- The light source of this lamp is not replaceable; when the light source reaches its end of life the whole lamp shall be replaced.

CLEANING

Do not use solvents, corrosive cleaners or the like. Use a dry or slightly moist cloth for cleaning **ONLY**.



Waste electrical products should not be disposed of together with household waste. Please recycle where designated facilities exist. Check with your local authority or retailer for recycling advice.

- The battery must be removed from the appliance before it is scrapped.
- The appliance must be disconnected from the main power supply when removing the battery.
- The battery must be disposed of safely.

WARRANTY

We do not take responsibility for any damage caused by misuse or any use that is not in compliance with the safety standards described herein.

CUSTOMER SERVICES

Contact your local importer or your specialized dealer to obtain address of our service department.

**FROM DATE OF PURCHASE RECEIPT
2 YEAR GUARANTEE
ON MATERIAL OR PRODUCTION DEFECTS**

KRAFTWERK®

FAVORITE TOOLS SINCE 1979

KRAFTWERK Europe AG
Mettlenbachstrasse 23
CH-8617 Mönchaltorf
Switzerland
Tel. +41-44 949 40 50

KRAFTWERK Sàrl.
25, rue du Stade
F – 67870 Bischoffsheim
France
Tel. +33-388 48 64 50

www.kraftwerktools.com