

KRAFTWERK®

FAVORITE TOOLS SINCE 1979



GENERAL COLLECTION

www.kraftwerktools.com

KRAFTWERK®

FAVORITE TOOLS SINCE 1979

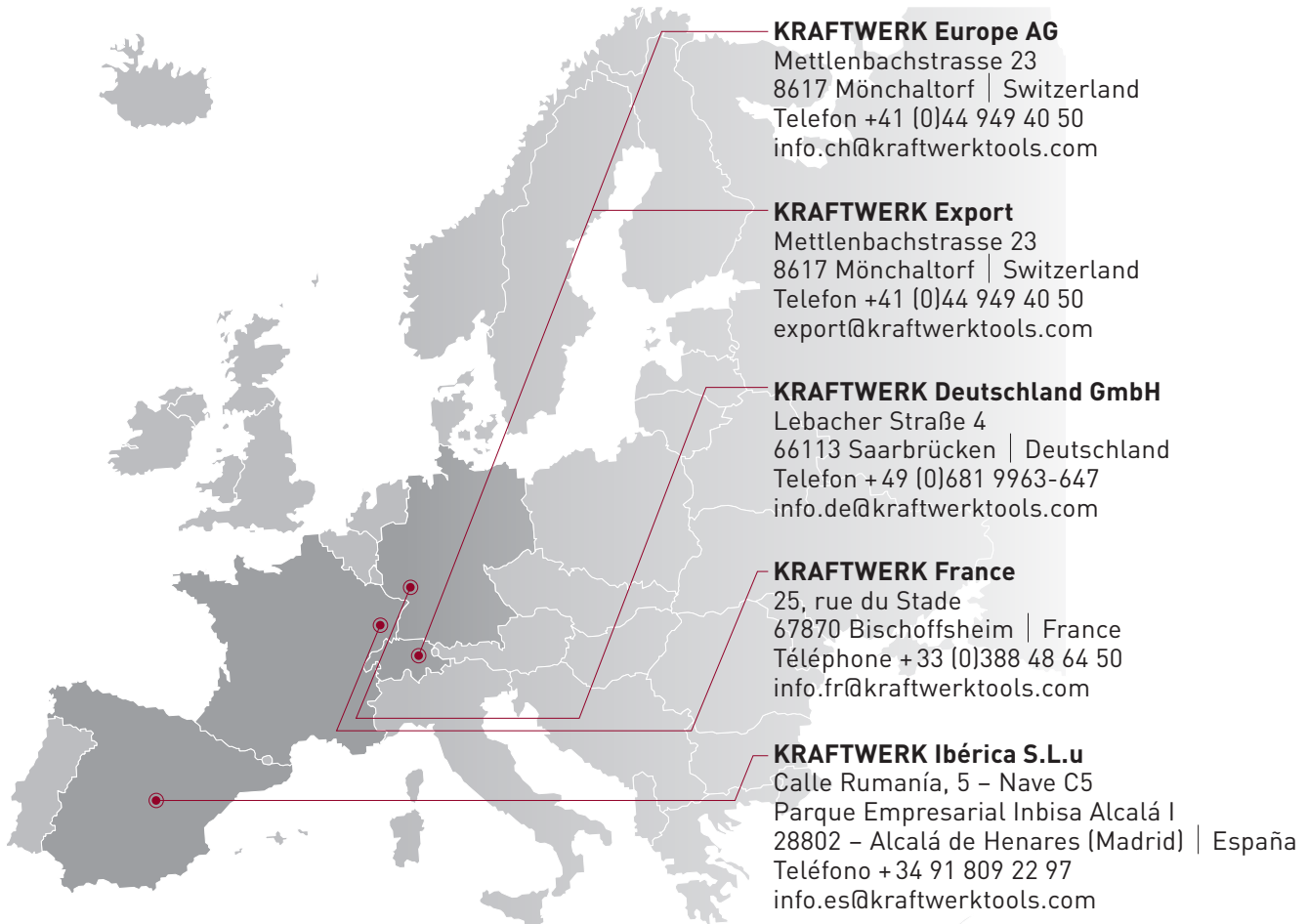

KRAFTWERK Europe AG

Mettlenbachstrasse 23
8617 Mönchaltorf | Switzerland
Telefon +41 (0)44 949 40 50
info.ch@kraftwerktools.com

KRAFTWERK Export

Mettlenbachstrasse 23
8617 Mönchaltorf | Switzerland
Telefon +41 (0)44 949 40 50
export@kraftwerktools.com

KRAFTWERK Deutschland GmbH

Lebacher Straße 4
66113 Saarbrücken | Deutschland
Telefon +49 (0)681 9963-647
info.de@kraftwerktools.com

KRAFTWERK France

25, rue du Stade
67870 Bischoffsheim | France
Téléphone +33 (0)388 48 64 50
info.fr@kraftwerktools.com

KRAFTWERK Ibérica S.L.u

Calle Rumanía, 5 – Nave C5
Parque Empresarial Inbisa Alcalá I
28802 – Alcalá de Henares (Madrid) | España
Teléfono +34 91 809 22 97
info.es@kraftwerktools.com

Follow us
Síguenos
Siga-nos



facebook.com/kraftwerktools



youtube.com/kraftwerktools



#kraftwerktools

www.kraftwerktools.com



5-103

1



105-217

2



219-255

3



257-327

4



329-369

5



371-385

6



387-399

7



401-409

8



411-433

9



Chemical resistant ABS top compartment with storage partitions.

*Superficie de trabajo en **ABS** con compartimento para piezas pequeñas, **resistente a productos químicos**.*

Topo em **ABS** com compartimentos, resistente aos produtos químicos.

1



One-finger operating and gently moving, **fully opening** ball bearing guided drawers, removable.

*Un solo dedo es suficiente para abrir totalmente cada cajón - **apertura total** de los cajones con sistema de rodamientos, extraíble.*

Um dedo apenas para **abrir totalmente** a gaveta, com sistema de rolamentos, removível.

2

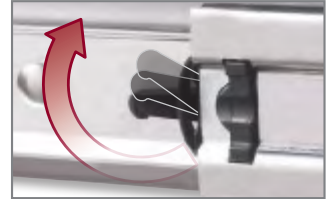

Single-handed, individual drawer locking device under the handle; the drawers are firmly locked also during the drive.

***Pestaña de cierre individual** de los cajones debajo de tiradores. Incluso durante el desplazamiento del carro los cajones quedan cerrados.*

Fechadura lateral individual por gaveta, abertura apenas com uma mão, gavetas devidamente fechadas mesmo durante o transporte.

3

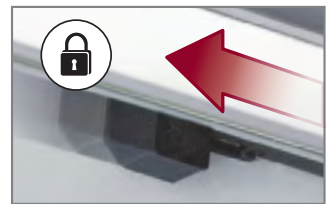

Wide range of accessories for direct mounting on the sturdy double wall construction of the tool cabinets.

Gran variedad de accesorios para montaje directo a la robusta construcción de doble pared de los carros.

Grande variedade de acessórios para instalação directa em parede dupla.

4

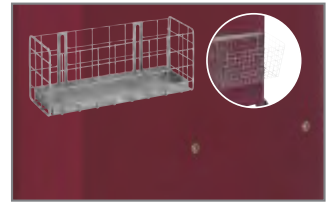

Handle strip with guide for **individual contents inscription**.

*Porta etiquetas para una **perfecta identificación del contenido**.*

Porta etiquetas para a **perfeita identificação do conteúdo**.

5



Central security locking system. Open drawers can also be pushed back in to closed cabinet.

Sistema de cierre central. Los cajones se pueden empujar hasta el final incluso en la posición cerrada.

Sistema de fechadura central. As gavetas abertas podem ser fechadas mesmo na posição de fechado.

6



High performance ball bearing guided wheels for optimal manoeuvre. Swivel rollers with brake-system.

***Ruedas de alta calidad con rodamientos** para una mejor maniobra. Ruedas pivote con sistema de frenado.*

Rodas de alta performance com rolamentos para manuseamento ágil. Rodas guia com travão.

7





Tool cabinet
Carro taller
Carro de ferramentas

Art.	
3907-1	6

	L1 / mm	L2 / mm	L3 / mm	⚖️ kg
	646	483	973	215
Top	646	483	25	50
A	533	414	70	25
B	533	414	110	30
C	533	414	230	30



Tool cabinet
Carro taller
Carro de ferramentas

Art.	
3908	8

	L1 / mm	L2 / mm	L3 / mm	⚖️ kg
	646	483	973	265
Top	646	483	25	50
A	533	414	60	25
B	533	414	110	30



Chest top for tool cabinets

Armario para carro

Baú para carro

Art.				
3905	4			
	L1 / mm	L2 / mm	L3 / mm	⚖️ kg
	646	483	973	130
Top	646	483	25	30
A	533	414	48	20
B	533	414	70	25
C	533	414	110	30

Fits for
Apropiado para
Encaixa em



3907-1



3908



EXTRA LARGO

Rolling work bench / extra long tool cabinet

with 12 bearing guided, single locking drawers, 9 of them optimally fitting for min. 27 COMPLETO tool-trays

- Compartment with door and 2 adjustable shelves
- Central locking
- 25 mm thick multiplex ply board, made in Germany
- 4 industrial PP-wheels, 2 fix and 2 steerable, with brakes
- Capacity: 30-35 kg each drawer
- Static carrying capacity: 450-500 kg.

EXTRA LARGO

Banco-carro extra largo

de 12 guías con rodamientos, cerradura individual para cada cajón, 9 cajones adaptados para 27 bandejas COMPLETO

- Compartimento con puerta y 2 estantes ajustables
- Cerradura central
- Superficie de trabajo en multiplex, grosor 25 mm, fabricado en Alemania
- 4 ruedas industriales de Polipropileno, 2 fijas y 2 giratorias, todas con frenos
- Capacidad: 30-35 kg por cajón
- Capacidad de carga estática: 450-500 kg.

EXTRA LARGO

Carro bancada extra largo

com 12 guias de rolamentos, tranca individual para cada gaveta, 9 gavetas adaptadas para 27 bandejas COMPLETO.

- Compartimento com porta e 2 prateleiras ajustáveis
- Fecho centralizado
- Superfície de trabalho em Multiplex, espessura 25 mm
- 4 rodas industriais em polipropileno, 2 fixas e 2 giratórias, todas com travões
- Capacidade: 30-35 kg por gaveta
- Capacidade de carga estática: 450-500 kg.



	L1 / mm	L2 / mm	L3 / mm	⚖️ kg
	1800	459	25	580
Top	1800	459	25	200
A	568	413	66	30
B	568	413	145	30
C	568	413	224	30
D	459	454	638	30
Shelf	459	454	638	10

Art.	⚖️ kg
3936	10

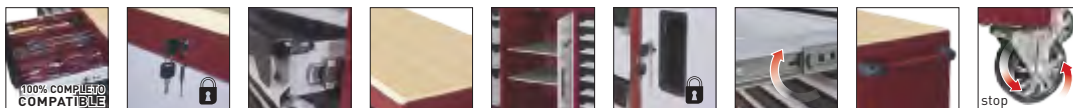

Service workshop trolley

with large tool tray, gently opening and closing due to gas springs, 3 ball bearing drawers, large bottom compartment.

Carro taller

con una gran bandeja, abriendo y cerrando suavemente gracias a los resortes de gas, 3 cajones con rodamientos, amplio compartimento inferior.

Carro multiuso

com bandeja grande, abrindo e fechando suavemente graças a molas de gás, 3 gavetas com guias de rolamentos, grande compartimento inferior.

Art.				
3917	3			
	L1 / mm	L2 / mm	L3 / mm	kg
	792	445	960	160
A	690	410	104	40
B	650	355	45	20
C	650	355	68	30
D	650	355	100	30
E	768	410	65	40



Tool cabinet

without tool-assortment

Carro

sin herramientas

Carro de ferramenta

sem ferramentas

Art.				
3934				
	L1 / mm	L2 / mm	L3 / mm	kg
	688	482	1013	235
Top	688	482	25	50
A	531	407	65	25
B	531	407	145	30



MDF top plate

for tool-cabinet 3934

Tablero MDF

para carro 3934

Painel MDF

para carro 3934

Art.	
3934-99	

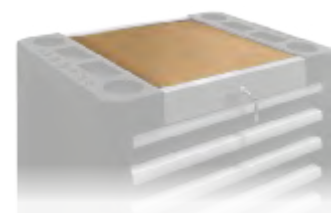

432 x 428 x 16 mm

Tool cabinet
without tool-assortment

Carro
sin herramientas

Carro de ferramenta
sem ferramentas

Art.				
3935				
	L1 / mm	L2 / mm	L3 / mm	⚖️ kg
	1044	482	1013	235
Top	1044	482	25	50
A	886	407	65	25
B	886	407	145	30

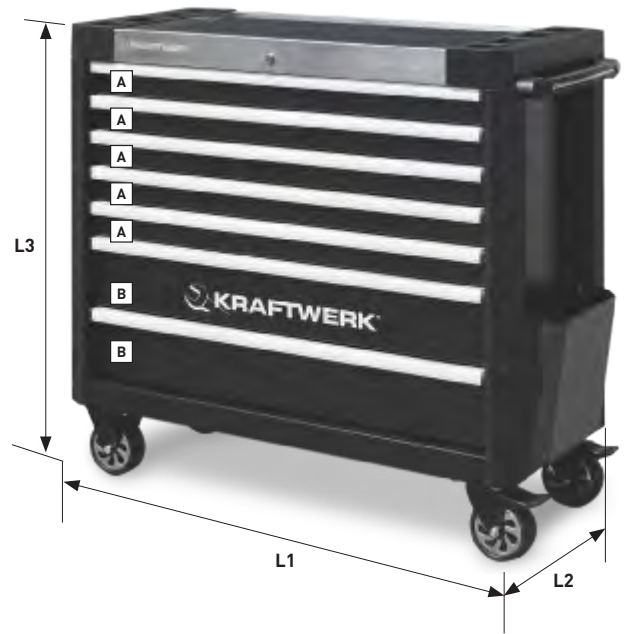

MDF top plate
for tool-cabinet 3935

Tablero MDF
para carro 3935

Painel MDF
para carro 3935

Art.	
3935-99	

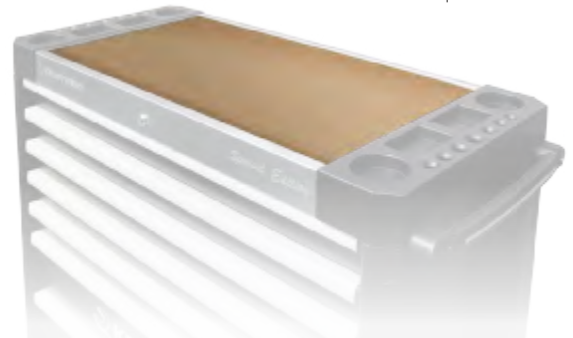

↕ 788 x 428 x 16 mm

Tool cabinet
with bearing guided and single locking, full pull-out drawer with central locking.

Carro taller
con cajones completamente extraíbles, con sistema de rodamientos, bloqueo individual y cerradura central.

Carro de ferramentas
com gavetas extensíveis com guias de rolamentos e trancas individuais e fecho centralizado.

Art.				
2905		5		
	L1 / mm	L2 / mm	L3 / mm	⚖️ kg
	695	475	1012	200
Top	533	408	25	50
A	536	410	60	25
B	536	410	124	30
C	536	410	172	30



Tool cabinet

with bearing guided and single locking, full pull-out drawer with central locking.

Carro taller

con cajones completamente extraíbles, con sistema de rodamientos, bloqueo individual y cerradura central.

Carro de ferramentas

com gavetas extensíveis com guias de rolamentos e trancas individuais e fecho centralizado.

Art.	
2907	7

	L1 / mm	L2 / mm	L3 / mm	kg
	695	475	885	240
Top	533	408	25	50
A	536	410	45	25
B	536	410	60	30
C	536	410	172	30



Top chest for tool cabinets Racing

with bearing guided and single locking, fully pull-out drawer with central locking.

Armario para carros Racing

con cajones completamente extraíbles, con sistema de rodamientos, bloqueo individual y cerradura central.

Baú para carros Racing

com gavetas extensíveis com guias de rolamentos e trancas individuais e fecho centralizado.

Art.	
2904	3

	L1 / mm	L2 / mm	L3 / mm	kg
	695	475	345	115
Top	533	408	25	30
A	536	410	60	25



Fits for
Apropiado para
Encaixa em



2905 **2907**

Rubber mat for drawers
Alfombrilla de goma para cajones
Tapete de borracha para gavetas

Art.	
3918	3907-1 / 3908 / 3905 3934 / 2905 / 2907 / 2904

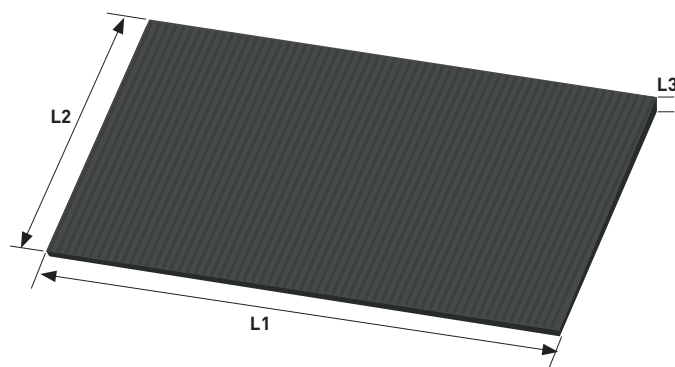

↕ L1 530 × L2 405 × L3 2 mm

Drawer divider insert
 made of galvanized metal sheet

Divisores "U" para cajones
 de acero galvanizado

Divisor em "U" para gaveta
 em chapa de metal galvanizado

Art.	
3919	3907-1 / 3908 / 3905

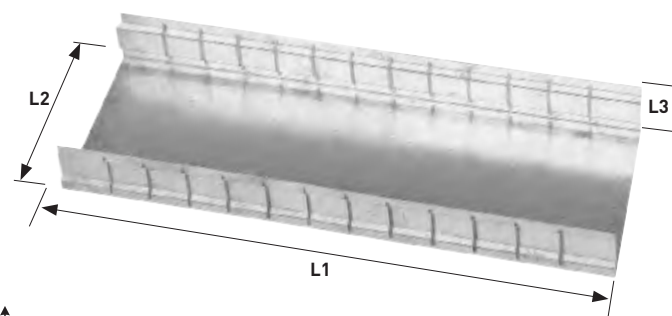

↕ L1 409 × L2 132 × L3 50 mm

Drawer divider
 for 3919, made of galvanized metal sheet

Divisores para cajones
 para 3919, de acero galvanizado

Divisória para gavetas
 para 3919, em chapa de metal galvanizado

Art.	
3920	3907-1 / 3908 / 3905

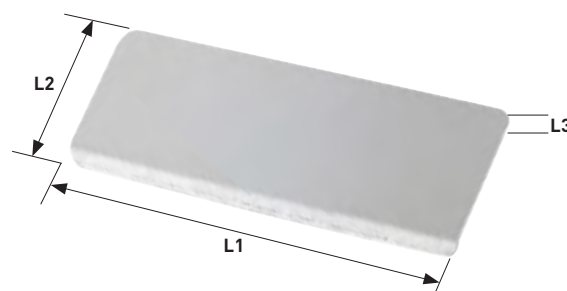

↕ L1 129 × L2 50 × L3 1.2 mm

Drawer compartment, flat
Bandeja fina cajón
Compartimento liso para gaveta

Art.	
3921	3907-1 / 3908 / 3905 / 3934 2905 / 2907 / 2904

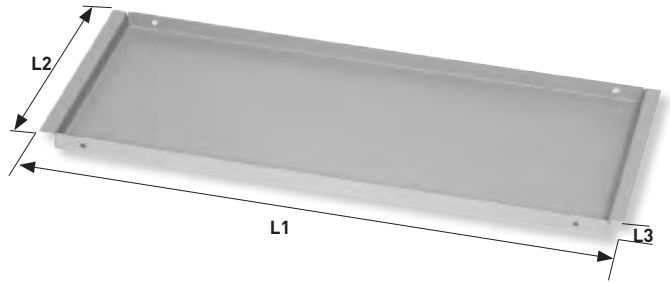

↕ L1 530 × L2 200 × L3 20 mm

Drawer compartment, deep
Bandeja profunda cajón
Compartimento fundo para gaveta

Art.	
3922	3907-1 / 3908 / 3905 2905 / 2907 / 2904

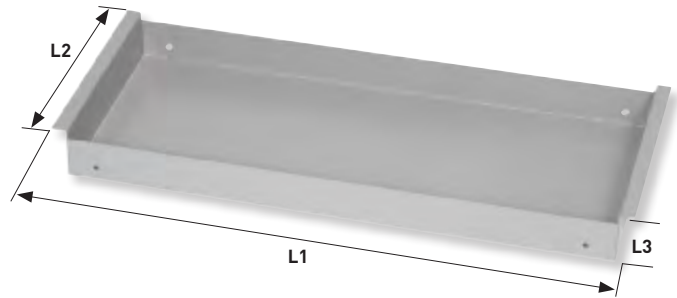

↕ L1 530 × L2 200 × L3 45 mm

Outside basket
with tray
Cubeta
con fondo
Cesto exterior
com fundo

Art.	
3923	3907-1 / 3908

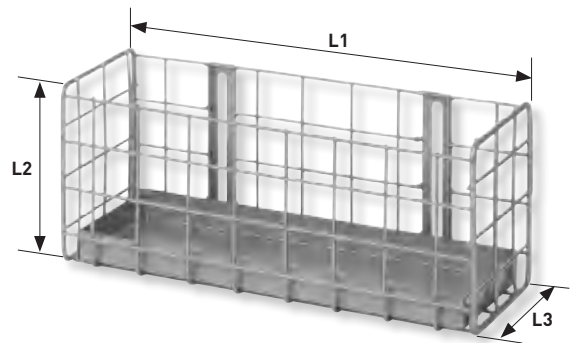

↕ L1 280 × L2 115 × L3 95 mm

Universal basket
with holder
Cubeta universal
con soporte
Cesto universal
com suporte

Art.	
3924	3907-1 / 3908

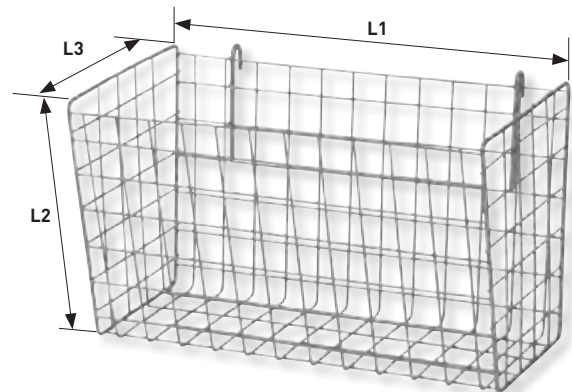
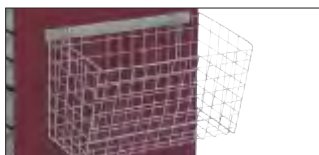

↕ L1 365 × L2 220 × L3 215 mm

Holding device for cleaning cloth rolls
Portarrollos
Suporte para rolos de papel

Art.	
3925	3907-1 / 3908

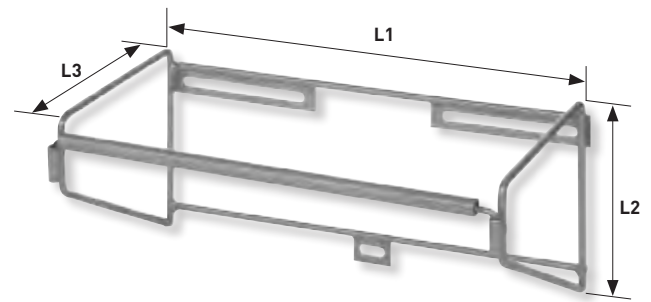

↕ L1 330 × L2 175 × L3 140 mm

Side table
 with integrated roll-holder for notebooks or additional utility space.

Panel lateral abatible
 con portarrollo integrado, para espacio adicional o para portátil.

Mesa lateral
 com porta rolos integrado, para computador portátil ou como espaço adicional.

Art.	
3927	3907-1 / 3908



↕ L1 385 × L2 380 × L3 375 mm

Tray set for small parts for 4920
Juego de bandejas piezas pequeñas para 4920
Jogo de bandejas vazias para pequenas peças para 4920

Art.	
3936ES	3936



9
PCS



↕ 405 × 45 × 42 mm

Side table for the KWR tool-cabinets
for notebooks or documents.

Panel lateral

espacio adicional para documentos o para portátil.

Mesa lateral

para computador portátil, documentos, etc.

Art.	
1927	2905 / 2907



↕ L1 280 × L2 210 mm

Magnetic tray

stainless

Bandeja magnética

inox

Recipiente magnético

em aço inox

Art.	
2950	1200 g



↕ Ø 150 × 40 × 40 mm

Magnetic tray

stainless

Bandeja magnética

inox

Recipiente magnético

em aço inox

Art.	
2951	2 × 1200 g

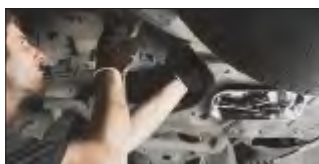

↕ 240 × 140 × 40 mm

Magnetic holder

for sockets and pneumatic tools

Soporte magnético

para herramientas neumáticas

Suporte magnético

para ferramentas pneumáticas

Art.

3929



↕ L 400 x 130 x 150 mm

Protection cover for tool cabinet

Cubierta de protección para carros

Cobertura de protecção para carros

Art.



3930

3907-1 / 3908 / 3934 / 2905 / 2907



↕ 73 x 55 x 89 mm

High quality
Modular elements workshop wall cabinet system

Alta calidad
Muebles modulares para taller

Alta qualidade
Sistema de armários modulares para oficina

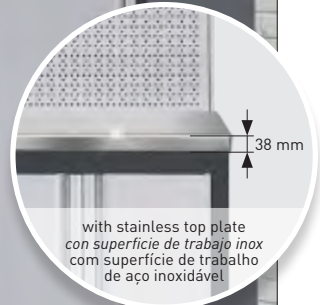
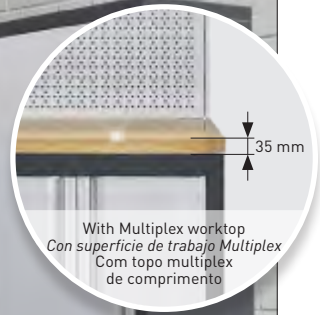

100% Compatible

COMPLETO SERIE 4900
COMPLETO EVA SERIE 4902
COMPLETO EVA3 SERIE 4903

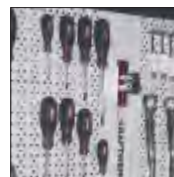

**Modular elements work-
shop wall cabinet system**

Individual compilation. Freestanding construction, no fixtures and no walls necessary, very flexible to install. Each module can be ordered individually. Ball-bearing guided drawers of different heights, suitable for all KRAFTWERK-tool inserts (COMPLETO-hardshells, EVA, EVA3). Central locking system and single locking drawers. Tool wall panels with standard Euro perforation.

**Muebles modulares
para taller**

Para un montaje personalizado en función de su necesidad. Construcción independiente, sin accesorios y muro de sujeción, instalación muy flexible. Cada módulo se puede pedir individualmente. Cajones de diferentes alturas, con guías de rodamientos de bola, apropiados para cualquier inserción KRAFTWERK (COMPLETO, EVA, EVA3) con cierre centralizado y cierre individual para cada cajón. Paneles con perforación estándar EURO.

**Sistema de armários
modulares para oficina**

para montagem personalizada em função das suas necessidades. Construção independente, isenta de fixações e paredes para colocação, com bastante flexibilidade de instalação. Cada módulo pode ser encomendado individualmente. Gavetas com calhas de rolagamentos de diferentes alturas, compatíveis com todos os módulos KRAFTWERK (COMPLETO, EVA, EVA3) e com tranca central bem como sistema de bloqueio individual. Paineis de parede com furação standard Euro.



3-Elements Storage System

- 2 Wall cabinets with gas spring
- 1 Locker with 4 shelves
- 1 2 door base cabinet with 1 shelf
- 1 5 drawer base cabinet
- 2 Hanging panels
- 1 Worktop

Mueble modular - 3 elementos

- 2 cajones abatibles con resortes a gas
- 1 armario alto con 4 baldas
- 1 armario bajo de 2 puertas con 1 balda
- 1 armario bajo con 5 cajones
- 2 paneles perforados de pared
- 1 superficie de trabajo

Móvel modular - 3 elementos

- 2 armários de parede com sistema hidráulico
- 1 armário alto com 4 prateleiras
- 1 estante com 2 portas com 1 prateleira
- 1 armário com 5 gavetas
- 2 painéis de pendurar ferramenta
- 1 topo

Art.	
3964A	With Multiplex worktop <i>Con superficie de trabajo Multiplex</i> Com topo multiplex de comprimento 1361 x 463 x 35 mm
3964AIX	With stainless top plate <i>Con superficie de trabajo en acero inoxidable</i> Com topo em aço inoxidável 1361 x 463 x 38 mm



4-Elements Storage System

- 3 Wall cabinets with gas spring
- 1 Locker with 4 shelves
- 1 2 doors base cabinet with 1 shelf
- 1 4 drawer base cabinet
- 1 5 drawer base cabinet
- 3 Hanging panels
- 1 Worktop

Mueble modular - 4 elementos

- 3 cajones abatibles con resortes a gas
- 1 armario alto con 4 baldas
- 1 armario bajo de 2 puertas con 1 balda
- 1 armario bajo con 4 cajones
- 1 armario bajo con 5 cajones
- 3 paneles perforados de pared
- 1 superficie de trabajo

Móvel modular - 4 elementos

- 3 armários de parede com sistema hidráulico
- 1 armário alto com 4 prateleiras
- 1 estante com 2 portas com 1 prateleira
- 1 armário com 4 gavetas
- 1 armário com 5 gavetas
- 3 painéis de pendurar ferramenta
- 1 topo

Art.

3964B

With Multiplex worktop
Con superficie de trabajo Multiplex
Com topo multiplex de comprimento
2041 x 463 x 35 mm

3964BIX

With stainless top plate
Con superficie de trabajo en acero inoxidable
Com topo em aço inoxidável
2041.5 x 463 x 38 mm



4-Elements Storage System

- 3 Wall cabinets with gas spring
- 1 2 door locker with 4 shelves
- 1 9 drawer base cabinet
- 1 7 drawer rolling base cabinet
- 1 Base cabinet with waste bin/ kitchen roll
- 3 Hanging panels
- 1 Worktop

Mueble modular - 4 elementos

- 3 cajones abatibles con resortes a gas
- 1 armario alto de 2 puertas con 4 baldas
- 1 armario bajo con 9 cajones
- 1 armario bajo con 7 cajones y ruedas
- 1 armario bajo con cubo y portarrollos
- 3 paneles perforados de pared
- 1 superficie de trabajo

Móvel modular - 4 elementos

- 3 armários de parede com sistema hidráulico
- 1 estante com 2 portas com 1 prateleira
- 1 armário com 9 gavetas
- 1 armário amovível com 7 gavetas
- 1 base com caixote de lixo / rolo de papel
- 3 painéis de pendurar ferramentas
- 1 topo

Art.

3964D

With Multiplex worktop
 Con superficie de trabajo Multiplex
 Com topo multiplex de comprimento
 2041 x 463 x 35 mm

3964DIX

With stainless top plate
 Con superficie de trabajo en acero inoxidable
 Com topo em aço inoxidável
 2041.5 x 463 x 38 mm



8-Elements Storage System

- 5 Wall cabinets with roller shutter
- 1 Corner wall cabinet with gas spring
- 1 Locker with 4 shelves
- 1 2 door locker with 4 shelves
- 1 2 door base cabinet with 1 shelf
- 1 1 door corner base cabinet
- 1 8 drawer base cabinet
- 1 4 drawer base cabinet
- 1 7 drawer rolling base cabinet
- 1 Base cabinet with waste bin/kitchen roll
- 4 Hanging panels
- 2 Hanging panels for 3964-16
- 3 Worktops

Mueble modular - 8 elementos

- 5 armarios altos con persiana
- 1 armario alto de esquina con resortes a gas
- 1 armario alto con 4 baldas
- 1 armario alto con 2 puertas y 4 baldas
- 1 armario con 2 puertas y 1 balda
- 1 armario de esquina con puerta
- 1 armario base con 8 cajones
- 1 armario base con 4 cajones
- 1 armario bajo con 7 cajones y ruedas
- 1 armario bajo con cubo y portarollos
- 4 paneles perforados de pared
- 2 paneles perforados de pared para 3964-16
- 3 superficies de trabajo

Móvel modular - 8 elementos

- 5 armários de parede com persiana
- 1 armário de canto com sistema hidráulico
- 1 armário alto com 4 prateleiras
- 1 armário de 2 portas com 4 prateleiras
- 1 armário de 2 portas com 1 prateleira
- 1 armário de canto com porta
- 1 armário com 8 gavetas
- 1 armário com 4 gavetas
- 1 armário amovível com 7 gavetas
- 1 armário com cesto de lixo e suporte para rolo de papel
- 4 painéis perfurados
- 2 painéis perfurados para 3964-16
- 3 topo

Art.

3964E With Multiplex worktop
Con superficie de trabajo Multiplex
Com topo multiplex de comprimento
864 x 864 x 35 mm
1361 x 463 x 35 mm
2041 x 463 x 35 mm

3964EIX With stainless top plate
Con superficie de trabajo en acero inoxidable
Com topo em aço inoxidável
865 x 865 x 38 mm
1361 x 463 x 38 mm
2041.5 x 463 x 38 mm



6-Elements Storage System

- 4 Wall cabinets with gas spring
- 2 Lockers with 4 shelves
- 1 2 door base cabinet with 1 shelf
- 1 4 drawer base cabinet
- 1 5 drawer base cabinet
- 1 9 drawer base cabinet
- 4 Hanging panels
- 2 Worktops

Mueble modular - 6 elementos

- 4 cajones abatibles con resortes a gas
- 2 armarios altos con 4 baldas
- 1 armario bajo de 2 puertas con 1 balda
- 1 armario bajo con 4 cajones
- 1 armario bajo con 5 cajones
- 1 armario bajo con 9 cajones
- 4 paneles perforados de pared
- 2 superficies de trabajo

Móvel modular - 6 elementos

- 4 armários de parede com sistema hidráulico
- 2 armários alto com 4 prateleiras
- 1 estante 2 portas com 1 prateleira
- 1 armário com 4 gavetas
- 1 armário com 5 gavetas
- 1 armário com 9 gavetas
- 4 painéis de pendurar ferramenta
- 2 topo

Art.

3964F

With Multiplex worktop
Con superficie de trabajo Multiplex
Com topo multiplex de comprimento
2x 1361 x 463 x 35 mm

3964FIX

With stainless top plate
Con superficie de trabajo en acero inoxidable
Com topo em aço inoxidável
2x 1361 x 463 x 38 mm

Locker

with 4 shelf boards

Armario alto

con 4 baldas

Armário alto

com 4 prateleiras

Art.	kg
3964-02	40

600 × 458 × 2000 mm



Shelf board

for 3964-02

Balda para armario

para 3964-02

Prateleira

para 3964-02

Art.	kg
3964-02-07	40

590 × 430 × 20 mm



Locker

with 2 doors and 4 shelf boards

Armario de 2 puertas

y con 4 baldas

Cacifo

com duas portas e 4 prateleiras

Art.	kg
3964-12	40

915 × 458 × 2000 mm



Shelf board

for 3964-12

Balda para armario

para 3964-12

Prateleira

para 3964-12

Art.	kg
3964-12-01	40

905 × 430 × 20 mm



Base cabinet

with 2 doors and 1 shelf board

Armario bajo de 2 puertas

con 1 balda

Estante

com 2 portas com 1 prateleira

Art.	kg
3964-03	40

600 × 458 × 910 mm



Base cabinet

with 4 drawers

Armario bajo

con 4 cajones

Armário

com 4 gavetas

Art.
3964-04

	L1 / mm	L2 / mm	L3 / mm	kg
	680	458	910	115
A	560	404	58	25
B	560	404	138	30
C	560	404	207	30



Base cabinet

with 5 drawers

Armario bajo

con 5 cajones

Armário

com 5 gavetas

Art.
3964-05

	L1 / mm	L2 / mm	L3 / mm	kg
	680	458	910	145
A	560	404	58	25
B	560	404	138	30



Base cabinet

with 8 drawers

Armario bajo

con 8 cajones

Armário

com 8 gavetas

Art.
3964-14

	L1 / mm	L2 / mm	L3 / mm	kg
	680	458	910	235
A	560	404	58	25
B	560	404	138	30

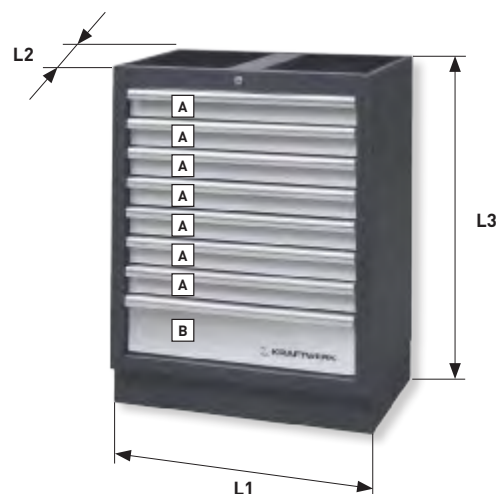

Base cabinet

with 9 drawers

Armario bajo

con 9 cajones

Armário

com 9 gavetas

Art.				
3964-13				

	L1 / mm	L2 / mm	L3 / mm	kg
	680	458	910	225
A	560	404	58	25

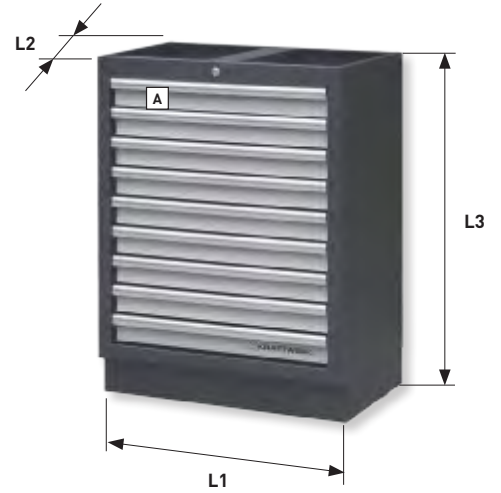

Rolling base cabinet

with 7 drawers

Armario bajo

con 7 cajones y ruedas

Armário amovível

com 7 gavetas

Art.				
3964-15				

	L1 / mm	L2 / mm	L3 / mm	kg
	646	458	862	230
Top	646	458	-	50
A	527	404	58	25
B	527	404	138	30

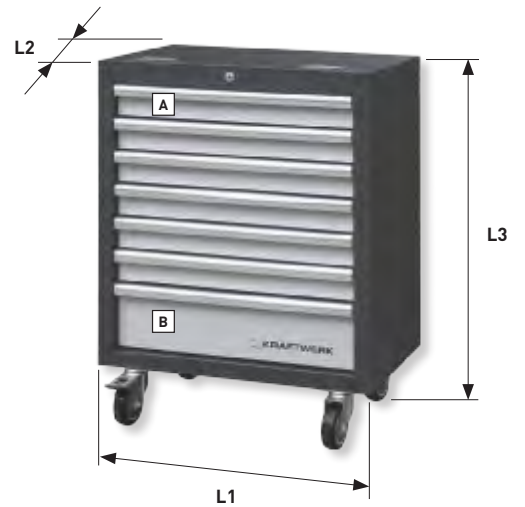

Base cabinet

with waste bin/kitchen roll

Armario bajo

con cubo y portarollos

Base

com caixote de lixo / rolo de papel

Art.				
3964-11				

860 × 458 × 910 mm



Corner base cabinet

with shelf

Mueble bajo de esquina

con 1 balda

Armário e canto

com 1 prateleira

Art.	kg
3964-16	30

860 × 450 mm

864 × 864 × 910 mm



Wall cabinet

with pneumatic spring action

Mueble alto

con resortes a gas

Armários de parede

com sistema hidráulico

Art.	kg
3964-01	15



680 × 281 × 350 mm

Wall cabinets

with roller shutter

Mueble alto

con persiana

Armários de parede

com persiana

Art.	kg
3964-19	15



680 × 281 × 350 mm

Corner wall cabinet

with gas spring

Armario alto de esquina

con resortes a gas

Armário de canto

com elevador a gás

Art.	kg
3964-25	20



865 × 865 × 350 mm



Hanging panel

for 3964-16

Panel perforado de pared

para 3964-16

Painel

para 3964-16

Art.
3964-17



1052 × 798 × 25 mm

Hanging panel

Panel perforado de pared

Painéis de pendurar ferramenta

Art.
3964-06

↕ 1052 × 614.5 × 25 mm



Connect support

for connections of 2 elements

Barra de conexión

para 2 elementos

Suporte de ligação

para dois elementos

Art.
3964-24

↕ 1420 × 65 × 30 mm



Connect support

for connections of 2 elements with cable holes

Conector de paneles perforados de pared

con orificios para cableado

Peça de ligação

para 2 elementos com furo para cabos

Art.
3964-07

↕ 1420 × 65 × 30 mm



Connect support for outer frame

Conector exterior de panel

Peça de ligação

Art.
3964-10

↕ 1420 × 32.5 × 30 mm



Multiplex worktop

for 1 element

Superficie de trabajo Multiplex

para 1 elemento

Topo multiplex de comprimento

para 1 elemento

Art.

3964-08

↕ 680 × 463 × 35 mm



Multiplex worktop

for 2 elements

Superficie de trabajo Multiplex

para 2 elementos

Topo multiplex de comprimento

para 2 elementos

Art.

3964-09

↕ 1361 × 463 × 35 mm



Multiplex worktop

for 3 elements

Superficie de trabajo Multiplex

para 3 elementos

Topo em multiplex

para 3 elementos

Art.

3964-18

↕ 2041 × 463 × 35 mm



Multiplex worktop

for 3964-16

Superficie de trabajo Multiplex

para 3964-16

Topo em multiplex

para 3964-16

Art.

3964-16-99

↕ 864 × 864 × 35 mm



Stainless top plate

for 1 element

Superficie de trabajo en acero inoxidable

para 1 elemento

Topo em aço inoxidável

para 1 elemento

Art.

3964-20

680 × 463 × 38 mm

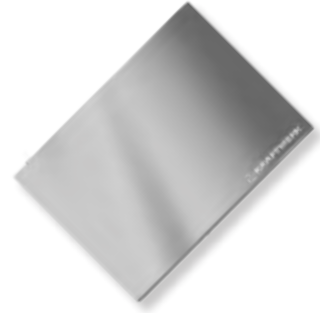

Stainless top plate

for 2 elements

Superficie de trabajo en acero inoxidable

para 2 elementos

Topo em aço inoxidável

para 2 elementos

Art.

3964-21

1361 × 463 × 38 mm



Stainless top plate

for 3 elements

Superficie de trabajo en acero inoxidable

para 3 elementos

Topo em aço inoxidável

para 3 elementos

Art.

3964-22

2041.5 × 463 × 38 mm



Stainless top plate

for 3964-16

Superficie de trabajo en acero inoxidable

para 3964-16

Topo em aço inoxidável

para 3964-16

Art.

3964-23

865 × 865 × 38 mm

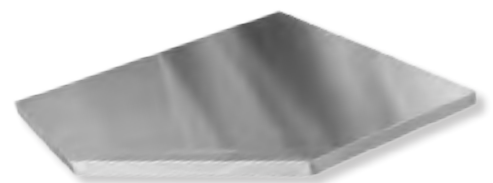

Pointed hook
Gancho
Grampo

Art.	L
90359	150 mm
90354	100 mm

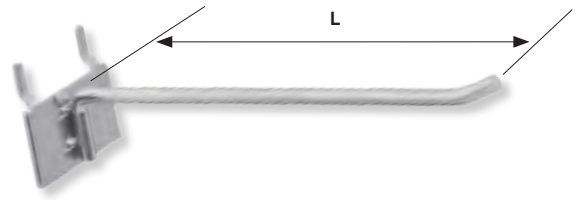

Pointed hook
Gancho
Grampo

Art.	L
90377	60 mm

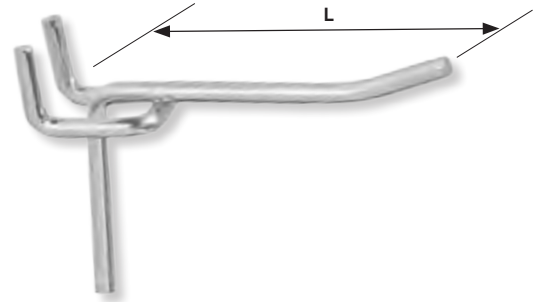

Holding device for cleaning cloth rolls
Portarrollos
Suporte para rolos de papel

Art.
3925

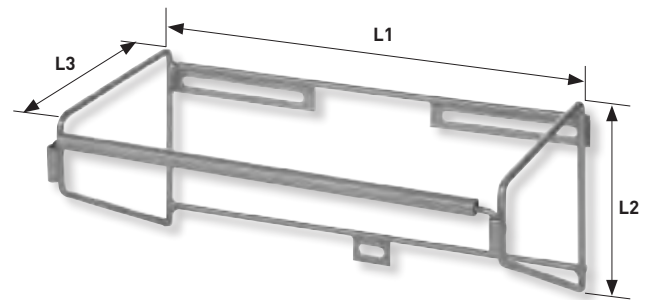

↕ L1 330 × L2 175 × L3 140 mm

Outside basket
with tray
Cubeta
con fondo
Cesto exterior
com fundo

Art.
3923

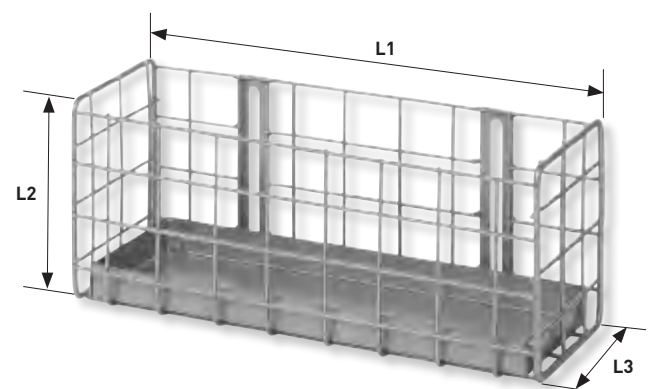

↕ L1 280 × L2 115 × L3 95 mm

Magnetic holder
for sockets and pneumatic tools

Soporte magnético
para herramientas neumáticas

Suporte magnético
para ferramentas pneumáticas

Art.
3929



↕ L 400 x 130 x 150 mm

LED down light

The lights are equipped with magnets and mounting brackets and therefore can be used flexibly. Both light sizes can be connected in series.

Luz LED baja

Las lámparas están equipadas con imanes y por lo tanto, pueden utilizarse de forma flexible. Ambos tamaños de lámpara se pueden conectar en serie si se desea.

Iluminação LED

As lampadas estão equipadas com ímãs e pode ser efectuada uma utilização flexível. Ambos os tamanhos de lampadas podem ser ligados em série, se desejado.

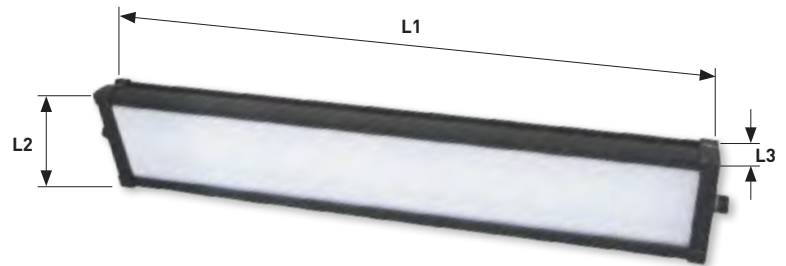
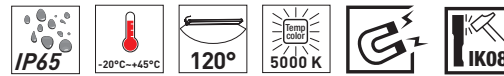

Art.	SMD-LED	LM	W	⚖️ kg
32077-60	120	1800	20	1.2
32077-120	240	3600	40	2.3

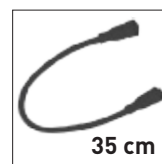

Accessories included
Accesorios incluidos
Acessórios incluídos

	L1 / mm	L2 / mm	L3 / mm
32077-60	590	124	43
32077-120	1200	124	43

Workbenches

with height-adjustable feet, 3 cm thick multiplex worktop, splash-proof, dirt-repellent and widely resistant to oil and grease.

Max. load-bearing capacity 150 kg

Bancos de trabajo

con ajuste de nivel, panel multiplex de 3 cm, resistente a salpicaduras de agua y polvo y muy resistente a aceites y grasas.

Carga máxima: 150 kg

Banco de trabalho

Com regulação de nível, tampo multiplex com 3 cm de espessura, à prova de salpicos, repelente de sujidade e resistente a óleos e massas.

Capacidade máxima de carga 150 kg

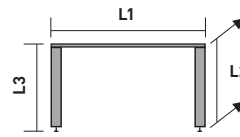

Art.
7526
7527

	L1 / mm	L2 / mm	L3 / mm	Δ kg
7526	1600	600	880 - 930	150
7527	1600	800	880 - 930	150

Workbench

in solid sheet steel construction with 20 mm strong beech wood Multiplex-worktop with protective linseed oil varnish. 3 ball bearing guided drawers. KRAFTWERK-tool inserts (COMPLETO-hard shells, EVA, EVA3) fit comfortably in the lower, long drawer. The tool wall panel and a wall cabinet offer plenty of storage space for tools.

Banco de trabajo

con estructura robusta de acero, superficie de trabajo Multiplex de 20 mm en madera de haya con protección de barniz de aceite de linaza. Las inserciones con herramientas KRAFTWERK (COMPLETO, EVA, EVA3) se colocan fácilmente en el cajón largo inferior. El panel perforado y el mueble abatible superior ofrecen mucho espacio para almacenar herramientas.

Bancada de trabalho

construção em aço sólido com tampo em faia de 20mm multiplex com protecção envernizada de óleo de linhaça. 3 gavetas com guias de rolamentos. Os módulos de ferramentas KRAFTWERK (COMPLETO, EVA, EVA3) são facilmente armazenados na última gaveta. O armário de parede e o painel de parede oferecem bastante espaço para ferramenta.



Art.
3962

	L1 / mm	L2 / mm	L3 / mm	Δ kg
	1145	635	1585	80
L4	457	423	93	20
L5	921	483	93	30

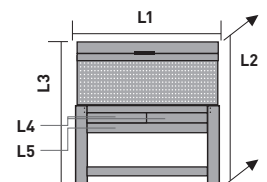



Tool-assortment

basic for 2 drawers

Surtido herramientas

básico para 2 cajones

Sortido de ferramentas

básico para 2 gavetas

Art.	
4909	4900-01B, 4900-03B, 4900-13B, 4900-04B, 4900-56B, 4900-07B

↔ L1 402 × L2 173 × L3 48 mm

Tool-assortment

with tool cabinet

Surtido herramientas

con carros

Sortido de ferramentas

com carro

	Art.
1	3907-4909
2	3908-4909
3	3905-4909
4	3934-4909
5	2905-4909
6	2907-4909
7	2904-4909



COMPLETO SERIE 4900



Tool-assortment

for 3 drawers

Surtido herramientas

para 3 cajones

Sortido de ferramentas

para 3 gavetas

Art.	
4911	4900-01B, 4900-03B, 4900-04B, 4900-13B, 4900-14B, 4900-07B, 4900-56B, 4900-10B, 4900-11B

↔ L1 402 × L2 173 × L3 48 mm

Tool-assortment

with tool cabinet

Surtido herramientas

con carro taller

Sortido de ferramentas

com carro

	Art.
1	3907-4911
2	3908-4911
3	3905-4911
4	3934-4911
5	2905-4911
6	2907-4911
7	2904-4911



Tool-assortment

with 24 inlays

Surtido herramientas

con 24 bandejas

Sortido de ferramentas

com 24 caixas



Art. 4920



Art. 4920F

Art.	
4920	4900-01B, 4900-02B, 4900-03B, 4900-38B, 4900-20B, 4900-19B, 4900-16B, 4900-22B, 4900-15B, 4900-13B, 4900-14B, 4900-40B, 4900-04B, 4900-05B, 4900-59B, 4900-11B, 4900-12B, 4900-73B, 4900-33B, 4900-57B1, 4900-09B, 4900-66B, 4900-10B, 4900-21B,
	4900-01B, 4900-02B, 4900-03B, 4900-38B, 4900-20B, 4900-19B, 4900-16B, 4900-22B, 4900-18B, 4900-13B, 4900-14B, 4900-40B, 4900-04B, 4900-05B, 4900-59B, 4900-11B, 4900-12B, 4900-73B, 4900-33B, 4900-57B1, 4900-09B, 4900-66B, 4900-10B, 4900-21B,

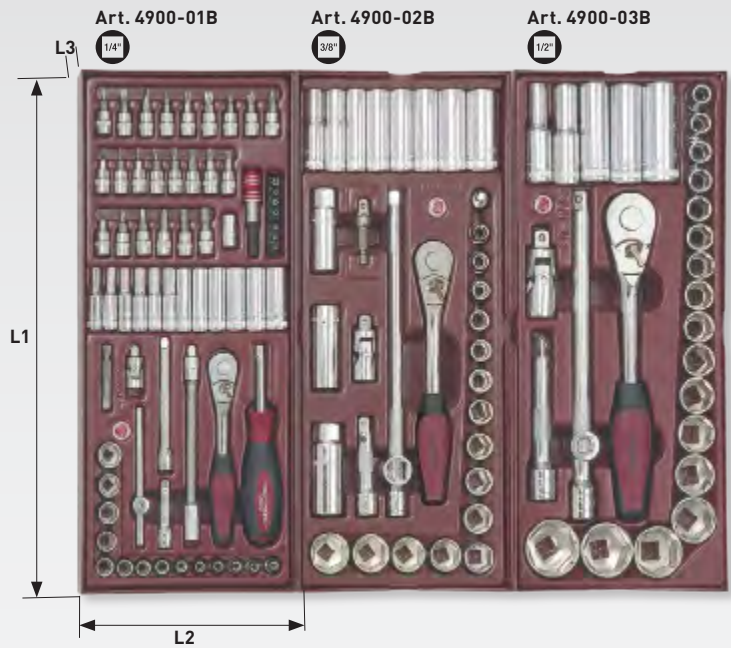

↔ L1 402 x L2 173 x L3 48 mm

Art. 4900-38B



Art. 4900-20B



Art. 4900-19B

Art. 4900-16B

Art. 4900-22B

Art. 4900-15B

(only / solamente / unico 4920)



COMPLETO SERIE 4900

Art. 4900-13B



Art. 4900-14B



Art. 4900-40B



Art. 4900-04B



Art. 4900-05B



Art. 4900-59B



Art. 4900-11B



Art. 4900-12B



Art. 4900-73B



Art. 4900-33B



Art. 4900-57B1



Art. 4900-09B



HIGHTECH 3C

4GRIP

Art. 4900-66B



Art. 4900-10B



Art. 4900-21B



Art. 4900-18B
(only / solamente / unico 4920F)



Tool-assortment
with tool-cabinet

Surtido herramientas
con carro

Sortido de ferramentas
com carro





561
PCS

Art. 4920

563
PCS

Art. 4920F



Art.		
3936-4920	12	
3936-4920F	12	

only / solamente /
unico 3936-4920



solo / solamente /
unico 3936-4920F

Art. 3936ES

9
PCS

COMPLETO SERIE 4900





















Socket wrench tray
Bandeja llaves vaso
Conjunto de chaves de caixa



Art.

4900-01B

↔ L1 402 × L2 173 × L3 48 mm

- | | | | | | |
|---|----|---|---|---|-----------------------------|
|  | 15 | 3.5-4-4.5-5-5.5-6-7-8-9-10-11-12-13-14 mm |  | 2 | 50 mm / 100 mm |
|  | 12 | 4-4.5-5-5.5-6-7-8-9-10-11-12-13 mm |  | | 150 mm |
|  | 3 | 4-5-5-6.5 mm |  | | 115 mm |
|  | 3 | PH 1-2-3 |  | | 1/4" 1/4" |
|  | 3 | PZ 1-2-3 |  | 7 | T10-T15-T20-T25-T27-T30-T40 |
|  | 8 | T8-T10-T15-T20-T25-T27-T30-T40 |  | | 1/4" 1/4" |
|  | 6 | 3-4-5-6-7-8 mm |  | | 1/4" 1/4" |
|  | | 1/4" 1/4" |  | | |
|  | | 1/4" 1/4" |  | | |
-  Art. 3200











Socket wrench tray
Bandeja llaves vaso
Conjunto de chaves de caixa



Art.

4900-02B

↔ L1 402 × L2 173 × L3 48 mm

- | | | |
|---|----|---|
|  | 15 | 8-9-10-11-12-13-14-15-16-17-18-19-21-22-24 mm |
|  | 8 | 10-11-12-13-14-15-17-19 mm |
|  | 3 | 16 mm / 18 mm / 21 mm |
|  | | 3/8" 3/8" |
|  | 2 | 75 mm / 250 mm |
|  | | 1/2" 3/8" |
|  | | 3/8" 1/4" |
|  | | 1/4" 3/8" |

 Art. 3210



Socket wrench tray
Bandeja llaves vaso
Conjunto de chaves de caixa



Art.
4900-03B

↔ L1 402 × L2 173 × L3 48 mm

- 17 10-11-12-13-14-15-16-17-18
19-21-22-24-27-30-32-34 mm
- 5 10-13-17-19-22 mm
- 1/2" 1/2"
- 2 125 mm / 250 mm
- 3/8" 1/2"
- 45 Art. 3220



inch
Socket wrench- and hex key tray inch
Bandeja llaves de vaso pulgadas
Conjunto de chaves de caixa em polegadas



Art.
4900-29B

↔ L1 402 × L2 173 × L3 48 mm

- 9 1/4" 3/16"-7/32"-1/4"-9/32"-5/16"
11/32"-3/8"-7/16"-1/2"
- 9 3/16"-7/32"-1/4"-9/32"-5/16"
11/32"-3/8"-7/16"-1/2"
- 1/4" 1/4"
- 2 50 mm / 100 mm
- 3/8" 1/4"
- 8 3/8" 9/16"-5/8"-11/16"-3/4"
13/16"-7/8"-15/16"-1"
- 3 9/16"-11/16"-3/4"
- 2 5/8"-13/16"
- 3/8" 3/8"
- 2 75 mm / 250 mm
- 1/2" 3/8"
- 72 Art. 4019
- 52 1/16"-5/64"-3/32"-1/8"-5/32"
3/16"-1/4"-5/16"-3/8"



Bit-socket tray
Bandeja vasos-punta
Conjunto de chaves de caixa com bit



Art.
4900-38B

↔ L1 402 × L2 173 × L3 48 mm

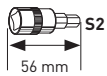

- 6 ⚙ T30-T40-T45-T50-T55-T60
- 6 ● 5-6-7-8-10-12 mm
- 6 ● M5-M6-M8-M10-M12-M14

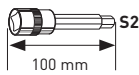

- 5 ⚙ T30-T40-T45-T50-T55
- 5 ● 6-7-8-10-12 mm
- 5 ● M5-M6-M8-M10-M12



Special bit-socket tray
Bandeja vasos-punta especiales
Conjunto de chaves de caixa com bit especial



AUTOMOTIVE

Art.
4900-58B

↔ L1 402 × L2 173 × L3 48 mm



- 9 ⚙ T20-T25-T27-T30-T40-T45-T50-T55-T60
- 7 ● 4-5-6-7-8-10-12 mm
- 5 ● M5-M6-M8-M10-M12

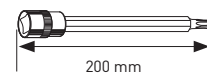

- 3 ⚙ T30-T40-T45



- 9 ⚙ T20-T25-T27-T30-T40-T45-T50-T55-T60
- 7 ● 4-5-6-7-8-10-12 mm
- 5 ● M5-M6-M8-M10-M12

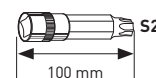

- ⚙ T70

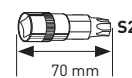

- ⚙ T80



- 3/8" ○ 5/16"
- 1/2" ○ 5/16"

38
PGS

Pass through socket wrench tray
Bandeja vasos pasantes
Conjunto de chaves de caixa de aperto



Art.

4900-49B

↔ L1 402 × L2 173 × L3 48 mm

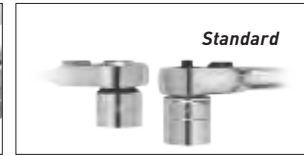
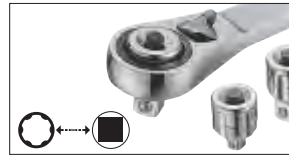

- | | | | | | | |
|--|----|-------|--|----------------------------------|--|-------------------|
| | 9 | 13 mm | | 3.5-4-4.5-5-5.5-6-7-8-9 mm | | 13 mm × 1/4" |
| | 10 | 20 mm | | 10-11-12-13-14-15-16-17-18-19 mm | | 20 mm × 3/8" |
| | 8 | 30 mm | | 20-21-22-24-27-30-32-34 mm | | 30 mm × 1/2" |
| | | 13 mm | | 75 mm | | 13 mm × 1/4" |
| | | 20 mm | | 75 mm | | |
| | 2 | 30 mm | | 75 mm / 155 mm | | |
| | | | | | | 13 mm Art. 590000 |
| | | | | | | 20 mm Art. 600000 |
| | | | | | | 30 mm Art. 610000 |

1/4" 3/8" 1/2" 5/16" **CrMo** **71** PGS

Special socket- and bit tray
Bandeja llaves vaso y puntas
Conjunto especial de chaves de impacto e bit



Art.

4900-20B

↔ L1 402 × L2 173 × L3 48 mm

- | | | | | | |
|--|----|------------------------------------|--|----|--|
| | 6 | E4-E6-E7-E8-E10-E11 | | 3 | 8-10-12 mm |
| | 7 | E10-E11-E12-E14-E16-E18-E20 | | 2 | PH 3-4 |
| | 5 | E16-E18-E20-E22-E24 | | 2 | PZ 3-4 |
| | 11 | 9-10-11-13-14-17-19-21-22-23-24 mm | | 6 | T40-T45-T47-T50-T55-T60 |
| | 5 | 17-19-21-22-24 mm | | 12 | T10-T15-T20-T25-T27-T30
T40-T45-T50-T55-T60-T70 |
| | | 3/8" 5/16" | | 5 | 6-8-10-12-14 mm |
| | | 1/2" 5/16" | | 4 | M6-M8-M10-M12 |

COMPLETO SERIE 4900

AUTOMOTIVE



Universal impact socket set
Juego universal de llaves de vaso impacto
Jogo universal de chaves impacto



Art.	
4900-70B	1/2"

↔ L1 402 × L2 173 × L3 48 mm

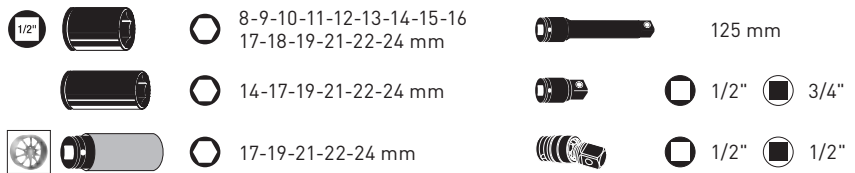

Impact wrench tray
Bandeja con herramienta neumática
Bandeja de chave de impacto



AUTOMOTIVE

Art.		
4900-71B	1/2"	3833
4900-71B1	1/2"	3834

↔ L1 402 × L2 173 × L3 48 mm

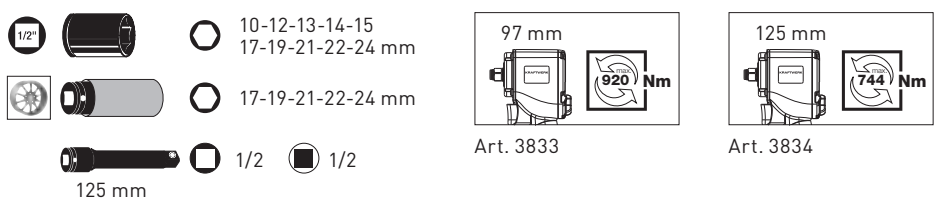

31
PGS

Combination wrench and ballpoint hex/TX key tray

*Bandeja llaves combinadas/
macho hexagonales bola/TX*

Conjunto de chaves de boca-luneta/sextavadas interior



Art.

4900-13B

↔ L1 402 × L2 173 × L3 48 mm



DIN 3113

Art. 3508	8 mm	Art. 3514	14 mm
Art. 3509	9 mm	Art. 3515	15 mm
Art. 3510	10 mm	Art. 3516	16 mm
Art. 3511	11 mm	Art. 3517	17 mm
Art. 3512	12 mm	Art. 3518	18 mm
Art. 3513	13 mm	Art. 3519	19 mm



DIN 2936 S2



Art. 3602
1.5-2-2.5-3-4-5-6-7-8-10 mm

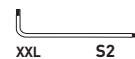

XXL S2

Art. 3607
T10-T15-T20-T25-T27
T30-T40-T45-T50

8
PGS

Combination wrench tray

Bandeja llaves combinadas

Conjunto de chaves de boca-luneta



Art.

4900-14B

↔ L1 402 × L2 173 × L3 48 mm

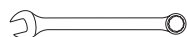

DIN 3113

Art. 3505	5.5 mm
Art. 3506	6 mm
Art. 3507	7 mm
Art. 3520	20 mm
Art. 3521	21 mm
Art. 3522	22 mm
Art. 3523	23 mm
Art. 3524	24 mm

COMPLETO SERIE 4900

15
PCS



inch

COMBINATION CLICKRAFT

Combination wrench tray inch
*Bandeja llaves combinadas
pulgadas*
Conjunto de chaves de boca-
luneta em polegadas



Art.

4900-30B

↕ L1 402 × L2 173 × L3 48 mm

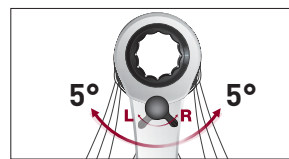

A 5/16"		C 7/16"		Art. 3587	1/4"	Art. 3594	11/16"
B 3/8"	Art. 3404-51612	D 1/2"		Art. 3588	5/16"	Art. 3595	3/4"
A 9/16"		C 11/16"		Art. 3589	3/8"	Art. 3596	13/16"
B 5/8"	Art. 3404-91634	D 3/4"		Art. 3590	7/16"	Art. 3597	7/8"
				Art. 3591	1/2"	Art. 3598	15/16"
				Art. 3592	9/16"	Art. 3599	1"
				Art. 3593	5/8"		

19
PCS



COMBINATION CLICKRAFT

Ratchet combination wrench tray
*Bandeja llaves combinadas
con carraca*
Conjunto de chaves de boca-
luneta com roquete



Art.

4900-17B

↕ L1 402 × L2 173 × L3 48 mm

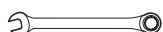

Art. 3405	5.5 mm
Art. 3406	6 mm
Art. 3407	7 mm
Art. 3408	8 mm
Art. 3409	9 mm
Art. 3410	10 mm
Art. 3411	11 mm
Art. 3412	12 mm
Art. 3413	13 mm

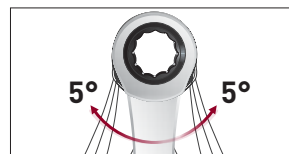

Art. 3414	14 mm	Art. 3691	1/4"	10 mm
Art. 3415	15 mm	Art. 3692	3/8"	13 mm
Art. 3416	16 mm	Art. 3693	1/2"	19 mm
Art. 3417	17 mm			
Art. 3418	18 mm	Art. 2694	1/4"	10 mm
Art. 3419	19 mm			





Double ratchet combination wrench tray

Bandeja llaves combinadas con doble carraca

Conjunto de chaves de boca-luneta com roquete duplo

**COMBINATION +
DOUBLE RATCHET
CLICKRAFT**



Art.

4900-40B

↔ L1 402 × L2 173 × L3 48 mm



Art. 3405	5.5 mm	Art. 3401-08	8 mm
Art. 3406	6 mm	Art. 3401-09	9 mm
Art. 3407	7 mm	Art. 3401-10	10 mm
		Art. 3401-11	11 mm
		Art. 3401-12	12 mm
		Art. 3401-13	13 mm
		Art. 3401-14	14 mm
		Art. 3401-15	15 mm
		Art. 3401-16	16 mm
		Art. 3401-17	17 mm
		Art. 3401-18	18 mm
		Art. 3401-19	19 mm

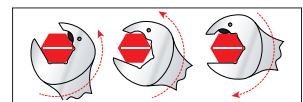

Optional / Opcional / Opcional

Art. 3691	1/4"	10 mm	
Art. 3692	3/8"	13 mm	
Art. 3693	1/2"	19 mm	
Art. 2694	1/4"	10 mm	



90° Ratchet combination wrench tray, extra long

Bandeja llaves combinadas 90° con carraca

Conjunto de chaves de boca-luneta com roquete 90°

**LARGO 90
CLICKRAFT**



Art.

4900-28B

↔ L1 402 × L2 173 × L3 48 mm



Art. 4405-08	8 mm	Art. 4405-14	14 mm
Art. 4405-09	9 mm	Art. 4405-15	15 mm
Art. 4405-10	10 mm	Art. 4405-16	16 mm
Art. 4405-11	11 mm	Art. 4405-17	17 mm
Art. 4405-12	12 mm	Art. 4405-18	18 mm
Art. 4405-13	13 mm	Art. 4405-19	19 mm

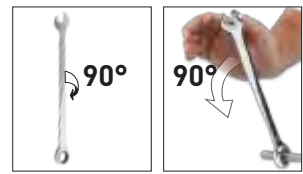

COMPLETO SERIE 4900

REVERSIBLE CLICKRAFT



Reversible ratchet combination wrench tray
Bandeja llaves combinadas reversibles con carraca
 Conjunto de chaves de boca-luneta com roquete reversível



Art.

4900-47B

↕ L1 402 × L2 173 × L3 48 mm

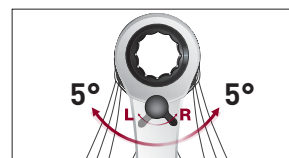

Art. 3404-08	8 mm	Art. 3404-15	15 mm
Art. 3404-09	9 mm	Art. 3404-16	16 mm
Art. 3404-10	10 mm	Art. 3404-17	17 mm
Art. 3404-11	11 mm	Art. 3404-18	18 mm
Art. 3404-12	12 mm	Art. 3404-19	19 mm
Art. 3404-13	13 mm	Art. 3404-22	22 mm
Art. 3404-14	14 mm	Art. 3404-24	24 mm



Flexible ratchet combination wrench tray
Bandeja llaves combinadas flexibles con carraca
 Conjunto de chaves de boca-luneta com roquete flexível

FLEX CLICKRAFT



Art.

4900-46B

↕ L1 402 × L2 173 × L3 48 mm

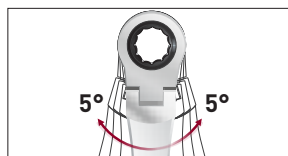

Art. 3403-08	8 mm	Art. 3403-15	15 mm
Art. 3403-09	9 mm	Art. 3403-16	16 mm
Art. 3403-10	10 mm	Art. 3403-17	17 mm
Art. 3403-11	11 mm	Art. 3403-18	18 mm
Art. 3403-12	12 mm	Art. 3403-19	19 mm
Art. 3403-13	13 mm	Art. 3403-22	22 mm
Art. 3403-14	14 mm	Art. 3403-24	24 mm

12
PGS 

ANGLE CLICKRAFT

Angle ratchet combination
wrench tray

*Bandeja llaves combinadas
angulares con carraca*

Conjunto de chaves de boca-
luneta com roquete angular



Art.

4900-41B





↔ L1 402 × L2 173 × L3 48 mm



	
Art. 3402-08	8 mm
Art. 3402-09	9 mm
Art. 3402-10	10 mm
Art. 3402-11	11 mm
Art. 3402-12	12 mm
Art. 3402-13	13 mm

Art. 3402-14	14 mm
Art. 3402-15	15 mm
Art. 3402-16	16 mm
Art. 3402-17	17 mm
Art. 3402-18	18 mm
Art. 3402-19	19 mm

Optional / Opcional / Opcional

	Art. 3691	● 1/4" ■ 10 mm	
	Art. 3692	● 3/8" ■ 13 mm	
	Art. 3693	● 1/2" ■ 19 mm	
	Art. 2694	● 1/4" ○ 10 mm	

10
PGS

Double open wrench tray

Bandeja llaves fijas

Conjunto de chaves de boca



Art.

4900-16B

↔ L1 402 × L2 173 × L3 48 mm



DIN 3110

Art. 3560	6 × 7 mm	Art. 3565	16 × 17 mm
Art. 3561	8 × 9 mm	Art. 3566	18 × 19 mm
Art. 3562	10 × 11 mm	Art. 3567	21 × 22 mm
Art. 3563	12 × 13 mm	Art. 3568	24 × 27 mm
Art. 3564	14 × 15 mm	Art. 3569	30 × 32 mm

11
PCS

Double offset wrench tray
Bandeja llaves dobles
Conjunto de chaves de luneta



Art.
4900-15B

↔ L1 402 × L2 173 × L3 48 mm

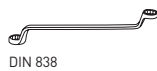

DIN 838

Art. 3480	6 × 7 mm	Art. 3486	18 × 19 mm
Art. 3481	8 × 9 mm	Art. 3487	20 × 22 mm
Art. 3482	10 × 11 mm	Art. 3488	21 × 23 mm
Art. 3483	12 × 13 mm	Art. 3489	24 × 27 mm
Art. 3484	14 × 15 mm	Art. 3491	30 × 32 mm
Art. 3485	16 × 17 mm		

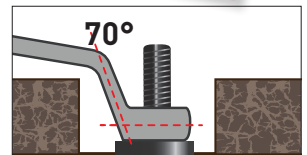

13
PCS



Flare nut wrench/stubby ratchet combination wrench tray
Bandeja llaves racores/ llaves combinadas cortas con carraca
Conjunto de chaves de luneta abierta/chaves boca-luneta com roquete flexível, curtas



**STUBBY FLEX
CLICKRAFT**

Art.
4900-22B

↔ L1 402 × L2 173 × L3 48 mm

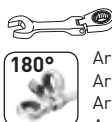
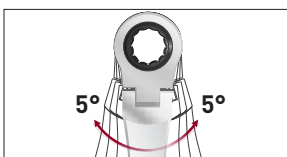

Art. 3403-08S	8 mm	Art. 3580-00	9 × 11 mm
Art. 3403-10S	10 mm	Art. 3580-01	10 × 12 mm
Art. 3403-11S	11 mm	Art. 3580-02	13 × 14 mm
Art. 3403-12S	12 mm	Art. 3580-03	15 × 17 mm
Art. 3403-13S	13 mm	Art. 3580-04	3/8" × 7/16"
Art. 3403-14S	14 mm	Art. 3580-05	1/2" × 9/16"
		Art. 3580-06	5/8" × 11/16"



13
PGS

Elbow milled open wrench trays

Bandeja llaves pipa

Conjunto de chaves de cachimbo

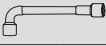

Art.	
4900-18B	
4900-48B	

↔ L1 402 × L2 173 × L3 48 mm

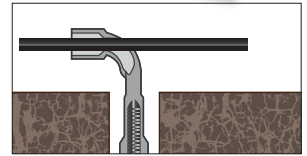
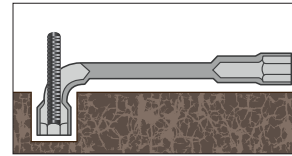

4900-18B

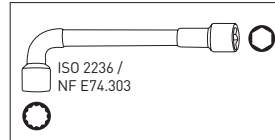

Art. 2598-08	8 mm
Art. 2598-09	9 mm
Art. 2598-10	10 mm
Art. 2598-11	11 mm
Art. 2598-12	12 mm
Art. 2598-13	13 mm
Art. 2598-14	14 mm

Art. 2598-15	15 mm
Art. 2598-16	16 mm
Art. 2598-17	17 mm
Art. 2598-18	18 mm
Art. 2598-19	19 mm
Art. 2598-22	22 mm

4900-48B

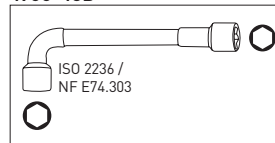

Art. 2597-08	8 mm
Art. 2597-09	9 mm
Art. 2597-10	10 mm
Art. 2597-11	11 mm
Art. 2597-12	12 mm
Art. 2597-13	13 mm
Art. 2597-14	14 mm

Art. 2597-15	15 mm
Art. 2597-16	16 mm
Art. 2597-17	17 mm
Art. 2597-18	18 mm
Art. 2597-19	19 mm
Art. 2597-22	22 mm

14
PGS

Straight box wrench tray

Bandeja llaves tubo

Conjunto de chaves de tubos sextavadas



Art.
4900-23B

↔ L1 402 × L2 173 × L3 48 mm



DIN 896

Art. 2599-06076	× 7 mm
Art. 2599-08098	× 9 mm
Art. 2599-101110	× 11 mm
Art. 2599-121312	× 13 mm
Art. 2599-141514	× 15 mm
Art. 2599-161716	× 17 mm

Art. 2599-1819	18 × 19 mm
Art. 2599-2022	20 × 22 mm
Art. 2599-2123	21 × 23 mm
Art. 2599-2427	24 × 27 mm
Art. 2599-2528	25 × 28 mm
Art. 2599-3032	30 × 32 mm

	Art. 2599-1012	210 mm
---	----------------	--------

	Art. 2599-3457	165 mm
---	----------------	--------

9
PCS

Double flexible socket wrench tray

Bandeja llaves flexibles doble vaso

Conjunto de chaves de caixa duplas flexíveis



Art.

4900-27B

↔ L1 402 × L2 173 × L3 48 mm



- Art. 2590-0809 8 × 9 mm
- Art. 2590-1011 10 × 11 mm
- Art. 2590-1213 12 × 13 mm
- Art. 2590-1415 14 × 15 mm
- Art. 2590-1617 16 × 17 mm
- Art. 2590-1819 18 × 19 mm

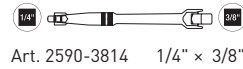
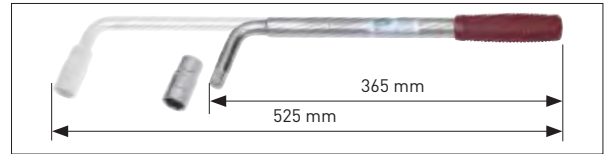

Art. 2590-3814 1/4" × 3/8"

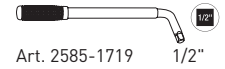

Art. 2585-1719 1/2"



17 × 19 mm



PB Swissgrip screwdriver tray
Bandeja destornilladores
PB Swissgrip
Conjunto de chaves de parafusos PB Swissgrip

Art.

4900-60B

↕ L1 402 × L2 173 × L3 48 mm



- Art. PB 8100 5 1.2 × 8 mm
- Art. PB 8100 4-140 1.0 × 6.5 mm
- Art. PB 8100 3-120 0.8 × 5.5 mm
- Art. PB 8100 2-100 0.6 × 4.0 mm
- Art. PB 8100 1- 90 0.5 × 3.5 mm
- Art. PB 8190 1- 80 PH1 × 80
- Art. PB 8190 2-100 PH2 × 100/6
- Art. PB 8451 10 × 30 mm
- Art. PB 1750 110-250 V

PB SWISS TOOLS

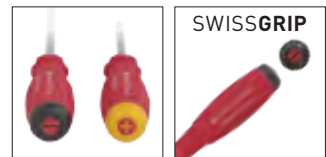

T10-T15-T20-T25-T27-T30-T40



Screwdriver tray
Bandeja destornilladores
Conjunto de chaves de parafusos

Art.

4900-04B

↕ L1 402 × L2 173 × L3 48 mm



ERGOKRAFT

- Art. 4110-1 0.6 × 3 mm
- Art. 4110-2 0.8 × 4 mm
- Art. 4110-3 1.0 × 5 mm
- Art. 4110-4 1.1 × 6 mm
- Art. 4110-5 1.2 × 8 mm
- Art. 4112-2 1.1 × 6 mm
- Art. 4117-2 PH 2
- Art. 2138 100-250 V
- Art. 4115-1 PH 1
- Art. 4115-2 PH 2
- Art. 2139 12 V

COMPLETO SERIE 4900

ERGOKRAFT



Screwdriver tray
Bandeja destornilladores
Conjunto de chaves de parafusos





Art.

4900-05B

↔ L1 402 × L2 173 × L3 48 mm

- | | | | |
|---|---|--------------|-----|
|  | ★ | Art. 4125-08 | T8 |
| | | Art. 4125-10 | T10 |
| | | Art. 4125-15 | T15 |
| | | Art. 4125-20 | T20 |
| | | Art. 4125-25 | T25 |
| | | Art. 4125-27 | T27 |
| | | Art. 4125-30 | T30 |
| | | Art. 4125-40 | T40 |

- | | | | |
|--|---|--------------|---------------|
|  | ○ | Art. 3177-20 | 0.45 × 2.0 mm |
| | | Art. 3177-24 | 0.5 × 2.4 mm |
| | | Art. 3177-30 | 0.6 × 3.0 mm |
| | | Art. 3177-35 | 0.65 × 3.5 mm |

- | | | | |
|--|---|-------------|------|
|  | + | Art. 3177-0 | PH 0 |
| | | Art. 3177-1 | PH 1 |



Impact screwdriver tray
Bandeja destornilladores de golpe
Conjunto de chaves de parafusos impacto



Art.

4900-54B

↔ L1 402 × L2 173 × L3 48 mm

- | | | | | |
|---|---|-------------|---------------|---------|
|  | ○ | Art. 4140-3 | 5.5 × 100 mm | 5.5 mm |
| | | Art. 4140-4 | 6.5 × 125 mm | 6.5 mm |
| | | Art. 4140-5 | 8.0 × 150 mm | 8.0 mm |
| | | Art. 4140-6 | 10.0 × 175 mm | 10.0 mm |

- | | | | | |
|---|---|-------------|--------------|--------|
|  | + | Art. 4145-1 | PH1 × 75 mm | 5.0 mm |
| | | Art. 4145-2 | PH2 × 100 mm | 6.0 mm |

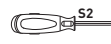
- | | | | | |
|---|---|-------------|--------------|--------|
|  | + | Art. 4150-1 | PZ1 × 75 mm | 5.0 mm |
| | | Art. 4150-2 | PZ2 × 100 mm | 6.0 mm |

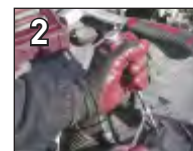
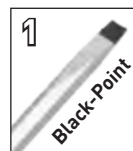



Socket nut driver tray

Bandeja de destornilladores de tuercas

Conjunto de Cháves de caixa de punho



ERGOKRAFT

Art.

4900-31B

↕ L1 402 × L2 173 × L3 48 mm



- | | |
|---------------|--------|
| Art. 4127-055 | 5.5 mm |
| Art. 4127-06 | 6 mm |
| Art. 4127-07 | 7 mm |
| Art. 4127-08 | 8 mm |
| Art. 4127-10 | 10 mm |
| Art. 4127-11 | 11 mm |
| Art. 4127-12 | 12 mm |
| Art. 4127-13 | 13 mm |



Ballpoint hex T-screwdriver tray

Bandeja destornilladores hexagonales bola en T

Conjunto de chaves sextavadas interior



ERGOKRAFT

Art.

4900-25B

↕ L1 402 × L2 173 × L3 48 mm

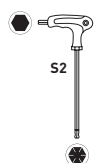

- | | |
|--------------|-------|
| Art. 3636-3 | 3 mm |
| Art. 3636-4 | 4 mm |
| Art. 3636-5 | 5 mm |
| Art. 3636-6 | 6 mm |
| Art. 3636-7 | 7 mm |
| Art. 3636-8 | 8 mm |
| Art. 3636-10 | 10 mm |



TX T-screwdriver tray

Bandeja destornilladores TX en T

Conjunto de chaves T TX

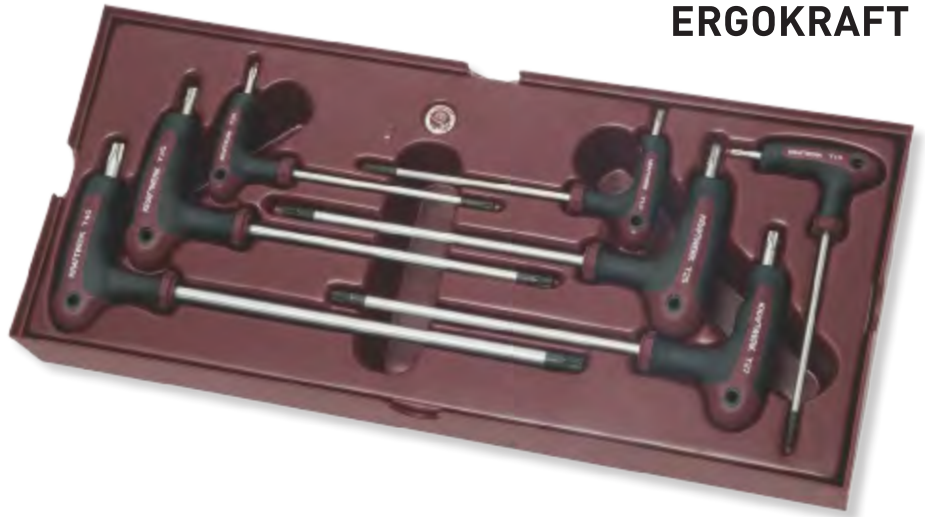

Art.
4900-26B

↔ L1 402 × L2 173 × L3 48 mm

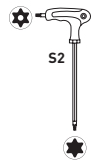

Art. 3637-10	T10
Art. 3637-15	T15
Art. 3637-20	T20
Art. 3637-25	T25
Art. 3637-27	T27
Art. 3637-30	T30
Art. 3637-40	T40



Hexagon T-handle wrench tray

Bandeja llaves T hexagonales

Conjunto de chaves T sextavadas interior



Art.
4900-35B

↔ L1 402 × L2 173 × L3 48 mm

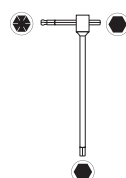

Art. 2593-02	2 mm
Art. 2593-025	2.5 mm
Art. 2593-03	3 mm
Art. 2593-04	4 mm
Art. 2593-05	5 mm
Art. 2593-06	6 mm
Art. 2593-07	7 mm
Art. 2593-08	8 mm
Art. 2593-10	10 mm

9
PCS

TX T-handle wrench tray
Bandeja llaves T TX
Conjunto de chaves T TX



Art.

4900-36B

↔ L1 402 × L2 173 × L3 48 mm

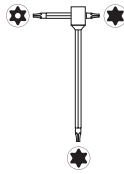

- | | |
|--------------|-----|
| Art. 2594-10 | T10 |
| Art. 2594-15 | T15 |
| Art. 2594-20 | T20 |
| Art. 2594-25 | T25 |
| Art. 2594-27 | T27 |
| Art. 2594-30 | T30 |
| Art. 2594-40 | T40 |
| Art. 2594-45 | T45 |
| Art. 2594-50 | T50 |

85
PCS

Universal special tool and bit-ratchet/-driver tray
Bandeja herramientas y puntas especiales
Conjunto especial de bit e roquetes/punhos



Art.

4900-19B

↔ L1 402 × L2 173 × L3 48 mm



- 6 4-4.5-5.5-6-6.5-8 mm
- 4 PH 1-2-3-4
- 4 PZ 1-2-3-4
- 8 T8-T10-T15-T20
T-25-T27-T30-T40
- 8 T8-T10-T15-T20
T-25-T27-T30-T40
- 6 3-4-5-6-7-8 mm
- 6 2-2.5-3-4-5-6 mm
- 6 5/64"-3/32"-7/64"
1/8"-9/64"-5/32"
- 3 Nos. 6-8-10
- 4 Nos. 1-2-3-4
- 4 Nos. 4-6-8-10

- 1/4" 1/4"
- 1/4" 1/4"
- 1/4" 1/4"
- Art. 3766 150 mm
- Art. 3767 300 mm
- 90 mm
- Art. 3634
- Art. 3798

- 5/16" 30 mm
- 4 6-8-10-12 mm
- 4 PH 1-2-3-4
- 4 T30-T40-T45-T50
- 3/8" 5/16"
- 5/16" 3/8"
- 90 mm
- 150 mm
- Art. 2035S





Electrician hex key wrench and socket wrench set VDE
with fully isolated reversible ratchet handle 1000V





Bandeja llaves hexagonales y llaves de vaso electricista VDE
con carraca reversible completamente aislado 1000V

Conjunto de chaves sextavadas em "L" e chaves de caixa de electricistas VDE
com roquete manual reversível completamente isolado 1000V

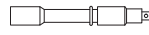

Art.
4900-61B

↔ L1 402 × L2 173 × L3 48 mm

	8	8-10-12-13-14-17-19-22 mm	
	Art. 3136-025	2.5 × 126 mm	
	Art. 3136-03	3.0 × 126 mm	
	Art. 3136-04	4.0 × 160 mm	
	Art. 3136-05	5.0 × 160 mm	
	Art. 3136-06	6.0 × 200 mm	
	Art. 3136-08	8.0 × 200 mm	
	Art. 207150V	3/8" × 150 mm	
	Art. 3210V	200 mm	



Electrician socket nut driver set VDE

Bandeja de destornilladores stecker electricista VDE

Conjunto de chaves de caixa de punho de electricistas VDE



Art.
4900-62B

↔ L1 402 × L2 173 × L3 48 mm

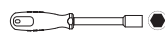
	Art. 3138-07	7.0 × 125 mm
	Art. 3138-08	8.0 × 125 mm
	Art. 3138-09	9.0 × 125 mm
	Art. 3138-10	10.0 × 125 mm
	Art. 3138-11	11.0 × 125 mm
	Art. 3138-12	12.0 × 125 mm
	Art. 3138-13	13.0 × 125 mm
	Art. 3138-14	14.0 × 125 mm



8
PCS

**Electrician screwdriver set
VDE**

*Bandeja de destornilladores
electricista VDE*



**Conjunto de chaves de para-
fusos de electricista VDE**



Art.

4900-63B

↔ L1 402 × L2 173 × L3 48 mm

	Art. 3132-1	2.5 × 75 mm
	Art. 3132-4	4.0 × 100 mm
	Art. 3132-5	5.5 × 125 mm
	Art. 3132-6	6.5 × 150 mm
	Art. 3135-0	PH0 × 60 mm
	Art. 3135-1	PH1 × 80 mm
	Art. 3135-2	PH2 × 100 mm
	Art. 2138	100-250 V



1000 V
IEC 60900

10
PCS

**Electrician TX screwdriver set
VDE**

with bore hole at the tip, for normal TX
screws and tamperproof TX screws

*Bandeja de destornilladores
TX electricista VDE*

*con punta perforada, para tornillos con
sin punta de seguridad*

**Conjunto de chaves TX de
electricistas VDE**

com furo, para parafusos normais e de
segurança



Art.

4900-64B

↔ L1 402 × L2 173 × L3 48 mm

	Art. 3133-06	T6 × 100 mm
	Art. 3133-07	T7 × 100 mm
	Art. 3133-08	T8 × 100 mm
	Art. 3133-10	T10 × 100 mm
	Art. 3133-15	T15 × 100 mm
	Art. 3133-20	T20 × 100 mm
	Art. 3133-25	T25 × 125 mm
	Art. 3133-27	T27 × 125 mm
	Art. 3133-30	T30 × 150 mm
	Art. 3133-40	T40 × 175 mm



1000 V
IEC 60900

10
PCS

Electrician hex key wrench and hex screwdriver set VDE

Bandeja llaves y destornilladores hexagonales machos electricista VDE

Conjunto de chaves em "L" e chaves de parafusos sextavadas de electricistas VDE



Art.
4900-65B



1000 V
IEC 60900

↔ L1 402 × L2 173 × L3 48 mm

	Art. 3134-025	2.5 × 100 mm
	Art. 3134-03	3.0 × 100 mm
	Art. 3134-04	4.0 × 125 mm
	Art. 3134-05	5.0 × 150 mm
	Art. 3134-06	6.0 × 175 mm
	Art. 3134-08	8.0 × 200 mm

	Art. 3136-03	3.0 × 126 mm
	Art. 3136-04	4.0 × 160 mm
	Art. 3136-05	5.0 × 160 mm
	Art. 3136-06	6.0 × 200 mm

6
PCS

Electrician pliers and cutting tool set VDE

Bandeja alicates y herramientas de corte electricista VDE

Conjunto de alicates e de ferramentas de corte de electricistas VDE



Art.
4900-67B

↔ L1 402 × L2 173 × L3 48 mm

	Art. 3281-180V DIN ISO 5746	180 mm
	Art. 3282-160V DIN ISO 5749	160 mm
	Art. 3285-200V DIN ISO 5745	200 mm
	Art. 2251V	
	Art. 3321V	
	4pcs. Art. 3321-4V	



1000 V
IEC 60900

4
PGS

HIGHTECH

Electrician pliers tray VDE
Bandeja alicates electricista VDE

Conjunto de alicates de electricistas VDE



Art.

4900-43B

↔ L1 402 × L2 173 × L3 48 mm



Art. 4211-180
DIN ISO 5746

180 mm **K C H**



Art. 4212-160
DIN ISO 5749

160 mm **K C H**



Art. 4215-205
DIN ISO 5745

200 mm **C H**



Art. 4219-160
DIN ISO 5232

160 mm



220 N/mm² 1800 N/mm²



1000 V
IEC 60900

4
PGS

Electrician pliers tray VDE
Bandeja alicates electricista VDE

Conjunto de alicates de electricistas VDE



Art.

4900-42B

↔ L1 402 × L2 173 × L3 48 mm



Art. 3281-180V
DIN ISO 5746

180 mm



Art. 3282-160V
DIN ISO 5749

160 mm



Art. 3285-200V
DIN ISO 5745

205 mm



Art. 3289-160V
DIN ISO 5232

160 mm



1000 V
IEC 60900

4
PCS

Industrial pliers tray
with 3 component handles

Bandeja alicates industriales
con mangos de 3 componentes

Conjunto de alicates industriais

com punhos de 3 componentes

Art.

4900-33B

↔ L1 402 × L2 173 × L3 48 mm

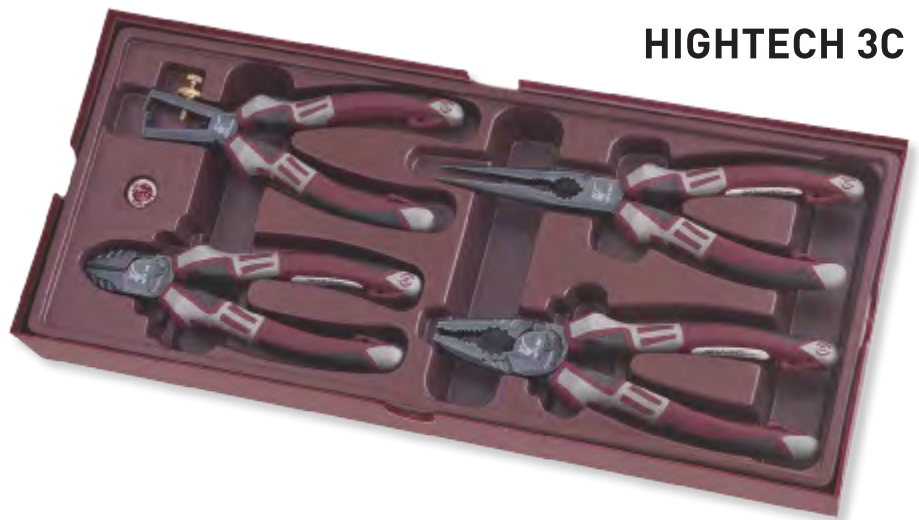

Art. 4271-180
DIN ISO 5746

180 mm **K C H**



Art. 4272-160
DIN ISO 5749

160 mm **K C H**

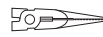

Art. 4275-205
DIN ISO 5745

205 mm **C H**



Art. 4279-160
DIN ISO 5232

160 mm



220 N/mm² 1800 N/mm²

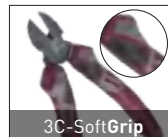

3C-SoftGrip

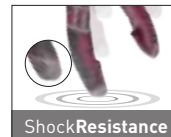

ShockResistance



TitaniumFinish

4
PCS

Pliers tray

Bandeja alicates

Conjunto de alicates

Art.

4900-07B

↔ L1 402 × L2 173 × L3 48 mm



Art. 3281-180
DIN ISO 5746

180 mm



Art. 3282-160
DIN ISO 5749

160 mm



Art. 3285-200
DIN ISO 5745

200 mm



Art. 3289-160
DIN ISO 5232

160 mm

5
PCS

Universal pliers tray
Bandeja universal alicates
Conjunto universal de alicates



Art.	
4900-57B1	4224-250
4900-57B2	4223-240
4900-57B3	4222-250

↔ L1 402 × L2 173 × L3 48 mm

HIGHTECH

4900-57B1 / Art. 4224-250



Art. 4276-205 205 mm
DIN ISO 5745

HIGHTECH 3C

Art. 3292-250 max. 250/10"

CrMo

Art. 3290-230 230 mm
ERGOKRAFT 1.5 - 6 mm² 1.5 - 4.6 mm²

VICTORINOX

4900-57B2 / Art. 4223-240



Art. 4276-205 205 mm
DIN ISO 5745

HIGHTECH 3C

Art. 3292-250 max. 250/10"

CrMo

Art. 3290-230 230 mm
ERGOKRAFT 1.5 - 6 mm² 1.5 - 4.6 mm²

VICTORINOX

4900-57B3 / Art. 4222-250

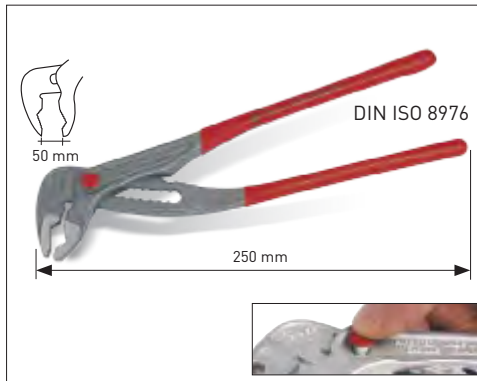

Art. 4276-205 205 mm
DIN ISO 5745

HIGHTECH 3C

Art. 3292-250 max. 250/10"

CrMo

Art. 3290-230 230 mm
ERGOKRAFT 1.5 - 6 mm² 1.5 - 4.6 mm²

VICTORINOX

4
PCS

Universal pliers tray
Bandeja universal alicates
Conjunto universal de alicates



Art.
4900-08B

↔ L1 402 × L2 173 × L3 48 mm

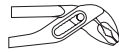

Art. 2221-250 250 mm
DIN ISO 8976

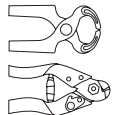

Art. 2216-200 200 mm
DIN ISO 9243

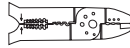

Art. 2262-07 7-1/2" 195 mm

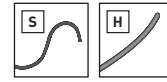

Art. 2225 240 mm 1.5 - 6 mm² 1.5 - 4.6 mm²

4
PCS

Circlips pliers tray
Bandeja alicates arandelas
Conjunto de alicates de freios



Art.
4900-09B

↔ L1 402 × L2 173 × L3 48 mm

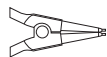

Art. 2212-A2
DIN ISO 5254A



Ø 19-60 mm

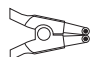

Art. 2213-A21
DIN ISO 5254B

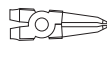

Art. 2214-J2
DIN ISO 5256C

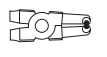

Art. 2215-J21
DIN ISO 5256D



5
PGS

Adjustable wrench and pliers tray

Bandeja llaves ajustables y alicates

Conjunto de chaves crescentes e de alicates



Art.

4900-21B

↕ L1 402 × L2 173 × L3 48 mm



ERGOKRAFT

Art. 3572 150 mm / 6" ○ 0-13 mm
Art. 3573 200 mm / 8" ○ 0-25 mm
DIN 3117 / ISO 6787



ERGOKRAFT M2

Art. 2243 250 mm HRC 58-60



Art. 3292-175 175 mm / 7" CrMo



Art. 3292-150 150 mm / 6" CrMo

11
PGS

Files tray

Bandeja limas

Conjunto de limas

ERGOKRAFT



Art.

4900-10B

↕ L1 402 × L2 173 × L3 48 mm



Art. 4320-1 320 mm
DIN 7261



Art. 4320-2 320 mm
DIN 7261



Art. 4320-3 320 mm
DIN 7261



Art. 4320-4 320 mm
DIN 7261



Art. 4320-5 320 mm
DIN 7261

▮ ▯ ▰ ▱ ▲ △ Art. 4321









22
PCS

Cutting tool tray
Bandeja herramientas corte
Conjunto de ferramentas de corte



Art.
4900-11B



↔ L1 402 × L2 173 × L3 48 mm

 ERGOKRAFT	Art. 3310	9 mm	 ERGOKRAFT	Art. 3308-1	
 12x	Art. 3313	9 mm	 HSS-Bimetall	Art. 3316-24	300 mm
 ERGOKRAFT	Art. 3312	18 mm	 ERGOKRAFT	Art. 2240	
 5x	Art. 3314	18 mm			
	Art. 3305	300 mm			

11
PCS

Striking tool tray
Bandeja herramientas golpe
Conjunto de martelos e punções



Art.		
4900-56B	Art. 2305	500 g
4900-66B	Art. 2319	500 g



↔ L1 402 × L2 173 × L3 48 mm

4900-56B / Art. 2305



4900-66B / Art. 2319

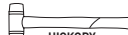
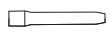

 HICKORY	Art. 2336	Ø 35 mm
	Art. 3380-18	18 mm
	Art. 3380-22	22 mm
	DIN 6451/53	
	Art. 1350-2	2 mm
	Art. 1350-3	3 mm
	Art. 1350-4	4 mm
	Art. 1350-5	5 mm
	Art. 1350-6	6 mm
	Art. 1350-8	8 mm
	DIN 6450 Form C	
	Art. 1358-2	No. 2
	DIN 7250	

9
PCS

Measuring tool tray
Bandeja herramienta medición
Conjunto de medição



Art.
4900-12B

↔ L1 402 × L2 173 × L3 48 mm

- | | | | |
|--|----------------|--|-------------|
| | Art. 4701-0519 | 5 m × 19 mm | |
| | Art. 2970 | 150 mm × 0.05 mm | 6" × 1/128" |
| | Art. 2975 | 0-25 mm × 0.01 mm | |
| | Art. 2976 | 300 mm × 28 mm | |
| | Art. 2977 | 200 mm | |
| | Art. 2978 | 100 mm × 70 mm | |
| | Art. 2974 | 0.05-0.1-0.15-0.2-0.3-0.4-0.5-0.6-0.7-0.8 mm | |
| | Art. 3196 | 130-630 mm / 2000 g | |
| | Art. 4996 | | |

HSS-G **40**
PCS

Drill bit and tap + die tray
Bandeja brocas-machos-terrajás
Conjunto de ferramentas de corte



Art.
4900-34B

↔ L1 402 × L2 173 × L3 48 mm

- | | | | | | | |
|--|------------|-----------------|--|--|------------|-----------------------|
| | Art. 23030 | M3 | | | Art. 11904 | 1-1.5-2-2.5-3-3.5-4 |
| | Art. 23040 | M4 | | | DIN 338 N | 4.5-5-5.5-6-6.5-7-7.5 |
| | Art. 23050 | M5 | | | | 8-8.5-9-9.5-10 mm |
| | Art. 23060 | M6 | | | | |
| | Art. 23080 | M8 | | | | |
| | Art. 23100 | M10 | | | Art. 11033 | 3.3 mm |
| | Art. 23120 | M12 | | | Art. 11042 | 4.2 mm |
| | | | | | Art. 11068 | 6.8 mm |
| | Art. 24200 | 0.25-6 mm / 60° | | | Art. 11102 | 10.2 mm |
| | | | | | DIN 338 N | |
| | Art. 24015 | M2-M12 | | | Art. 25030 | M3 |
| | DIN 1814 | | | | Art. 25040 | M4 |
| | | | | | Art. 25050 | M5 |
| | Art. 24110 | M3-M10 | | | Art. 25060 | M6 |
| | DIN 1814 | | | | Art. 25080 | M8 |
| | | | | | Art. 25100 | M10 |
| | | | | | Art. 25120 | M12 |
| | | | | | DIN 371 | |

HSS-G **42**
PCS

Drill bit and tap + die tray
Bandeja brocas-machos-terrajás
Conjunto de ferramentas de corte

Art.
4900-59B

↔ L1 402 × L2 173 × L3 48 mm



- Art. 26030 M3
- Art. 26040 M4
- Art. 26050 M5
- Art. 26060 M6
- Art. 26080 M8
- Art. 26100 M10
- Art. 26120 M12
- DIN / ISO 261



- Art. 11904 DIN 338 N 1-1.5-2-2.5-3-3.5-4-4.5-5-5.5-6-6.6-7-7.5-8-8.5-9-9.5-10 mm

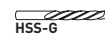

- Art. 11033 3.3 mm
- Art. 11042 4.2 mm
- Art. 11068 6.8 mm
- Art. 11102 10.2 mm
- DIN 338 N



- Art. 24200 0.25-6 mm / 60°



- Art. 25030 M3
- Art. 25040 M4
- Art. 25050 M5
- Art. 25060 M6
- Art. 25080 M8
- Art. 25100 M10
- Art. 25120 M12
- DIN 371



- Art. 24010 M3-M12
- DIN 225



- Art. 24015 M2-M12
- DIN 1814



- Art. 24110 M3-M10
- DIN 1814



- Art. 3240S 0.5 mm

HSS-G **77**
PCS

Threaded coil-insert repair tray
Bandeja reparación roscas
Conjunto de reparaçã de roscas

Art.
4900-51B

↔ L1 402 × L2 173 × L3 48 mm



- M4-M12, M6-M20
- 3/18"-1/2", 1/4"-3/4"



- M5×0.8, M6×1.0,
- M8×1.25, M10×1.5,
- M12×1.75, M14×1.25

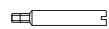

- M5×0.8, M6×1.0,
- M8×1.25, M10×1.5,
- M12×1.75, M14×1.25



- M5×0.8, M6×1.0,
- M8×1.25, M10×1.5,
- M12×1.75, M14×1.25



- 16 M5-0.8
- 12 M6-1.0
- 10 M8-1.25
- 6 M10-1.5
- 5 M12-1.75
- 4 M14-1.25



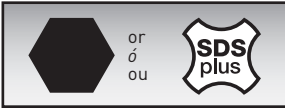





HSS
bimetal
M42+8%Co

Hole saw tray
Bandeja coronas perforadas
Conjunto de serras cranianas







Art.		
4900-39B		✓
4900-39BS		

↕ L1 402 × L2 173 × L3 48 mm

16
PCS

15
PCS

	Art. 19001		Art. 19005	14-30 mm / 3/8"
	Art. 19002		Art. 19006	32-76 mm / 7/16"
	Art. 19003			300 mm / 3/8"
	Art. 19190	19 mm	Art. 19380	38 mm
	Art. 19200	20 mm	Art. 19440	44 mm
	Art. 19220	22 mm	Art. 19510	51 mm
	Art. 19250	25 mm	Art. 19570	57 mm
	Art. 19290	29 mm	Art. 19680	68 mm
	Art. 19320	32 mm	Art. 19760	76 mm
	Art. 19350	35 mm		

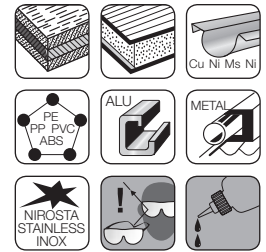

Modular workshop LED light tray

- extra strong 3 W COB LED lamp head
- extremely flat light head with 10 SMD LED 3 W for illuminating narrow space conditions
- flash light head with zoom function
- gooseneck light head
- 2 rechargeable exchangeable batteries
- vacuum suction lamp holder
- charging base battery-indicator, USB-mini charging cable and adapter for 100-240 V as well as 12-24 V car-/truck-adapter

Bandeja lámparas modulares LED taller

- lámpara extra fuerte de cabeza 3 W COB LED
- lámpara extraplana de cabeza con 10 SMD LED 3W, para iluminar en sitios de difícil acceso
- lámpara de bolsillo con función zoom
- lámpara flexo cuello de cisne
- 2 baterías recargables e intercambiables
- soporte de ventosa para lámparas
- indicador de carga de batería, cable de carga USB-mini, adaptadores 100-240 V y 12-24 V.

Conjunto modular de gambiarras LED para oficinas

- Gambiarra de cabeça articulada extra forte COB LED 3W
- Gambiarra de cabeça ultra fina com 10 SMD LED 3W para iluminação de locais de acesso difícil
- Cabeça da lanterna com função zoom
- Gambiarra "pescoço de cisne"
- 2 baterias recarregáveis e alternáveis
- Suporte ventosa para gambiarras
- Base carregadora com indicador de bateria, cabo mini carregador USB 100-240 V e adaptador para automóvel e camião 12-24 V.

11
PCS



Art. 4900-73B

421 x 200 x 68 mm

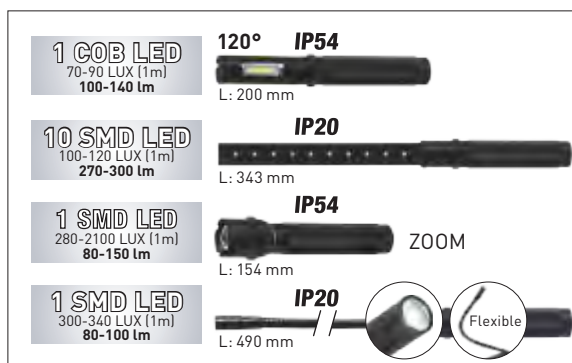
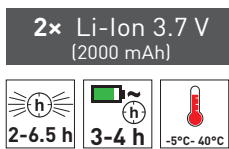

Art.

4900-73B

Tire pressure sensor tool tray

suitable for TPMS, for removing and mounting tyre pressure control systems. Optimal composition for all car models.

Bandeja útil con sensor para la presión de neumáticos

adecuado para TPMS, para extraer y montar los sistemas de control de presión de neumáticos. Composición óptima para todos los modelos.

Gaveta para ferramenta de sensores de pressão de pneus

compatível com TPMS, para remoção e montagem de sistemas de controlo da pressão dos pneus. Composição otimizada para todos os modelos.

1/4" 15 PCS

AUTOMOTIVE



2 11-12 mm

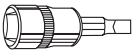

3 T10-T15-T20
4.5 mm



50 mm



Art. 3231

2.5-12 Nm / 20-105 Lb.in

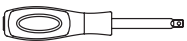

1/4" 1/4"



140 mm

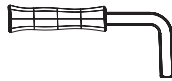

1/4" 100 mm



1/4"



1/4" 4 mm 0 Lb.in 150 mm
0.5-3.5 Nm / 4.5-30 Lb.in 150 mm



2 0.25-0.45 Nm / 2.2-4 Lb.in 120 mm



2 mm

421 x 200 x 68 mm

Art.

4900-74B

Adhesive weight pliers set

Juego herramientas para eliminar adhesivos

Conjunto de alicates para pesos de rodas

5 PCS

AUTOMOTIVE



Art. 4257-240 240 mm



Art. 3843 225 mm



Art. 3843RE Ø 100 x 15 mm



EN



SP



PT



421 x 200 x 68 mm

Art.

4900-75B

Special tray for small parts
Bandeja piezas pequeñas
Bandeja vazia para pequenas peças

Art.
4900-37B

↕ L1 402 × L2 173 × L3 48 mm



ABS injection tray
 empty
Bandeja en ABS
 vacía
Bandeja em ABS
 vazia

Art.
4900E

↕ L1 402 × L2 173 × L3 48 mm

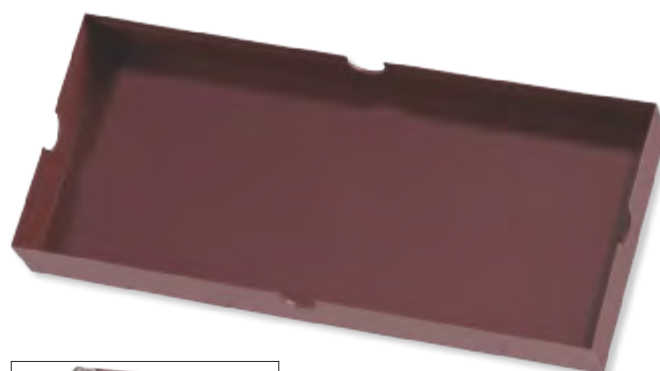

ABS blow mould case
 for COMPLETEO trays, empty
Estuche en ABS
 para conjuntos COMPLETEO, vacío
Mala em ABS
 vazia para conjuntos COMPLETEO

Art.
4900K

↕ L1 421 × L2 200 × L3 68 mm





COMPLETO EVA3 SERIE 4903

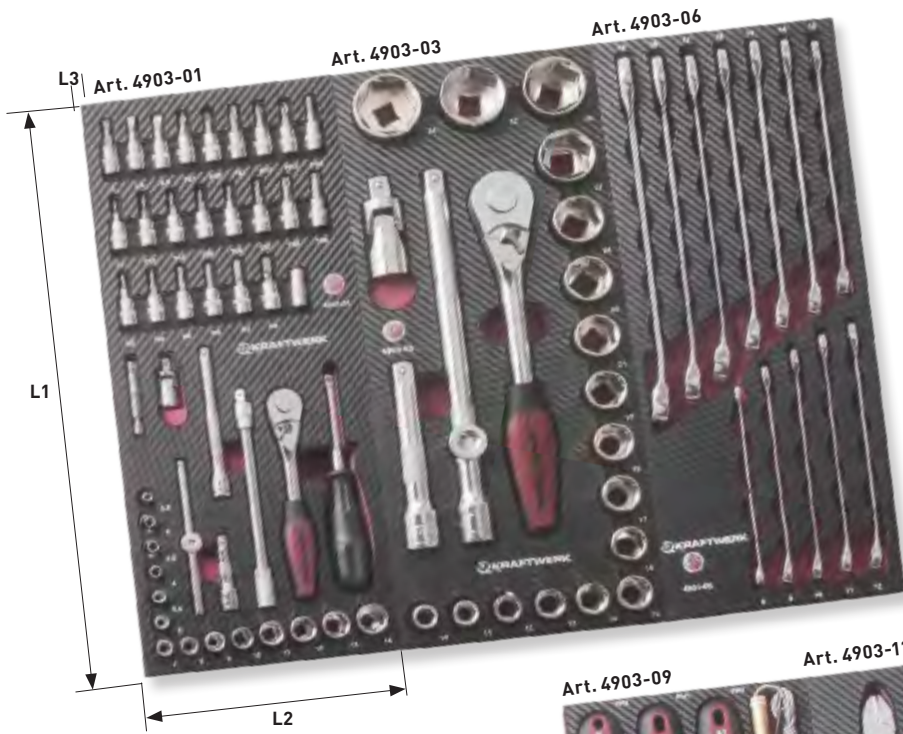

Tool-assortment

basic for 2 drawers

Surtido herramientas

básico para 2 cajones

Sortido de ferramentas

básico para 2 gavetas

Art.	
4931	4903-01, 4903-03, 4903-06, 4903-09, 4903-11, 4903-13

↔ L1 394 × L2 168 × L3 30 mm

Tool-assortment

with tool-cabinet

Surtido herramientas

con carros

Sortido de ferramentas

com carro

	Art.
1	3907-4931
2	3908-4931
3	3905-4931
4	3934-4931
5	2905-4931
6	2907-4931
7	2904-4931





Socket wrench tray
Bandeja con llaves de vaso
Gaveta com chaves de caixa

Art.
4903-01

↕ 394 x 168 x 30 mm



- | | | | | | |
|--|----|---|--|----|----------------|
| | 14 | 3.5-4-4.5-5-5.5-6-7-8-9-10-11-12-13-14 mm | | 2 | 50 mm / 100 mm |
| | 3 | 4-5.5-6.5 mm | | | 150 mm |
| | 3 | PH 1-2-3 | | | 115 mm |
| | 3 | PZ 1-2-3 | | | ○ 1/4" ■ 1/4" |
| | 8 | T8-T10-T15-T20-T25-T27-T30-T40 | | | ● 1/4" ■ 1/4" |
| | 6 | 3-4-5-6-7-8 mm | | | |
| | | ○ 1/4" ○ 1/4" | | | |
| | | ○ 1/4" ■ 1/4" | | | |
| | | | | 45 | Art. 3200 |



Socket wrench tray
Bandeja con llaves de vaso
Gaveta com chaves de caixa

Art.
4903-02

↕ 394 x 168 x 30 mm



- | | | |
|--|----|---|
| | 15 | 8-9-10-11-12-13-14-15-16-17-18-19-21-22-24 mm |
| | 8 | 10-11-12-13-14-15-17-19 mm |
| | 2 | 16 mm / 21 mm |
| | | ○ 3/8" ■ 3/8" |
| | 2 | 75 mm / 250 mm |
| | | ○ 1/2" ■ 3/8" |
| | | ○ 3/8" ■ 1/4" |
| | | ● 1/4" ■ 3/8" |

45 Art. 3210

COMPLETO EVA3 SERIE 4903













Socket wrench tray
Bandeja con llaves de vaso
Gaveta com chaves de caixa

Art.
4903-03

↕ 394 x 168 x 30 mm



-  17 10-11-12-13-14-15-16-17-18
19-21-22-24-27-30-32-34 mm
-   1/2"  1/2"
-  2 125 mm / 250 mm
-   3/8"  1/2"
-  (45)  Art. 3220











Bit-socket tray
Bandeja con vasos-punta
Gaveta com pontas

Art.
4903-04

↕ 394 x 168 x 30 mm



-  S2 5  5-6-7-8-10 mm
-  55 mm 5  M5-M6-M8-M10-M12
-  S2 5  6-7-8-10-12 mm
-  100 mm 4  M5-M6-M8-M10

1/2" S2 quality 19 PCS

Socket and bit-socket tray
Bandeja con vasos y vasos-punta
Gaveta com chaves de caixa e pontas



Art.
4903-05

↕ 394 x 168 x 30 mm

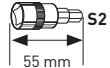
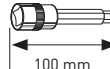
-  8 ⚙ E10-E12-E14-E16-E18-E20-E22-E24
-  S2 6 ⚙ T30-T40-T45-T50-T55-T60
55 mm
-  S2 5 ⚙ T30-T40-T45-T50-T55
100 mm

12 PCS

Combination wrench tray
Bandeja con llaves combinadas
Gaveta com chaves variadas



Art.
4903-06

↕ 394 x 168 x 30 mm

- 
- DIN 3113
- Art. 3508 8 mm
- Art. 3509 9 mm
- Art. 3510 10 mm
- Art. 3511 11 mm
- Art. 3512 12 mm
- Art. 3513 13 mm
- Art. 3514 14 mm
- Art. 3515 15 mm
- Art. 3516 16 mm
- Art. 3517 17 mm
- Art. 3518 18 mm
- Art. 3519 19 mm

8
PCS

Combination wrench tray
Bandeja con llaves combinadas
Gaveta com chaves variadas

Art.
4903-07

↕ 394 x 168 x 30 mm

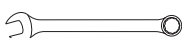

DIN 3113	
Art. 3505	5.5 mm
Art. 3506	6 mm
Art. 3507	7 mm
Art. 3520	20 mm
Art. 3521	21 mm
Art. 3522	22 mm
Art. 3523	23 mm
Art. 3524	24 mm

8
PCS

Double offset ring wrench tray
Bandeja con llaves acodadas
Gaveta com chaves luneta variadas

Art.
4903-08

↕ 394 x 168 x 30 mm

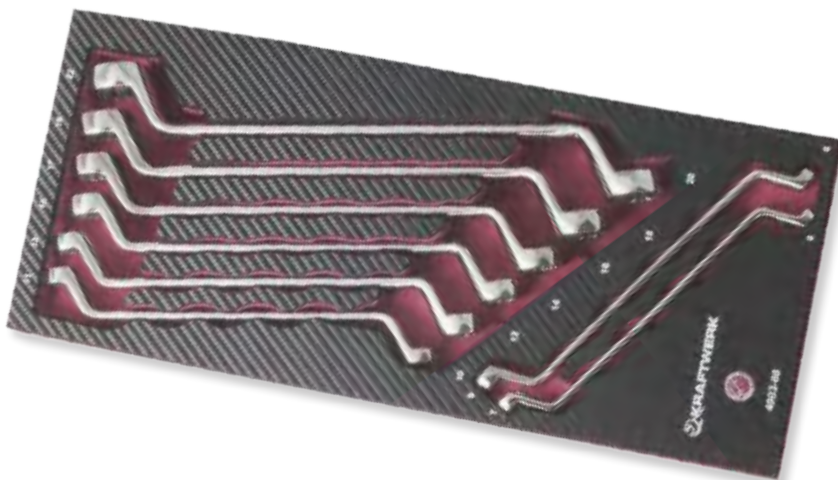

DIN 838		
Art. 3480	6 x 7 mm	Art. 3484 14 x 15 mm
Art. 3481	8 x 9 mm	Art. 3485 16 x 17 mm
Art. 3482	10 x 11 mm	Art. 3486 18 x 19 mm
Art. 3483	12 x 13 mm	Art. 3487 20 x 22 mm

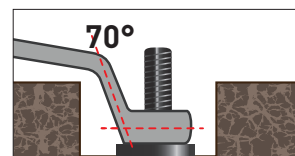



Combination wrench tray
Bandeja con llaves combinadas
Gaveta com chaves variadas

Art.
4903-16

↕ 394 x 168 x 30 mm



**COMBINATION
CLICKRAFT**



DIN 3113	
Art. 3408	8 mm
Art. 3409	9 mm
Art. 3410	10 mm
Art. 3411	11 mm
Art. 3412	12 mm
Art. 3413	13 mm
Art. 3414	14 mm
Art. 3415	15 mm
Art. 3416	16 mm
Art. 3417	17 mm
Art. 3418	18 mm
Art. 3419	19 mm

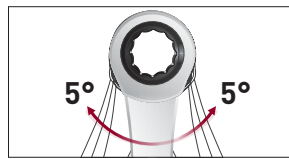

Double ratchet combination wrench tray
Bandeja llaves combinadas con doble carraca
Gaveta de chaves de boca-luneta com roquete duplo

Art.
4903-17

↕ 394 x 168 x 30 mm



**COMBINATION +
DOUBLE RATCHET
CLICKRAFT**

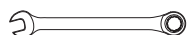

DIN 3113	
Art. 3401-08	8 mm
Art. 3401-09	9 mm
Art. 3401-10	10 mm
Art. 3401-11	11 mm
Art. 3401-12	12 mm
Art. 3401-13	13 mm
Art. 3401-14	14 mm
Art. 3401-15	15 mm
Art. 3401-16	16 mm
Art. 3401-17	17 mm
Art. 3401-18	18 mm
Art. 3401-19	19 mm

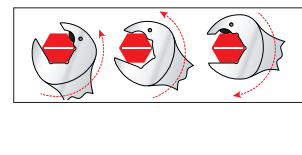
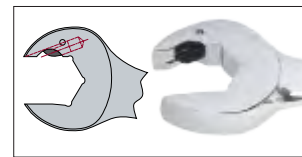
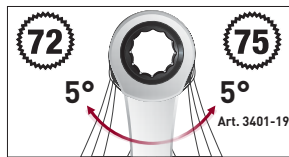

COMPLETO EVA3 SERIE 4903

REVERSIBLE CLICKRAFT

12
PCS



Reversible ratchet combination
wrench tray

*Bandeja llaves combinadas
reversibles con carraca*

Gaveta de chaves de boca-
luneta com roquete reversível



Art.

4903-18

↕ 394 x 168 x 30 mm

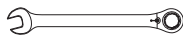

DIN 3113

Art. 3404-08	8 mm
Art. 3404-09	9 mm
Art. 3404-10	10 mm
Art. 3404-11	11 mm
Art. 3404-12	12 mm
Art. 3404-13	13 mm
Art. 3404-14	14 mm
Art. 3404-15	15 mm
Art. 3404-16	16 mm
Art. 3404-17	17 mm
Art. 3404-18	18 mm
Art. 3404-19	19 mm

CAP STOP

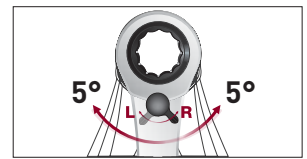

Art. 3404-19

13
PCS

Elbow milled open wrench trays

Bandeja llaves pipa

Conjunto de chaves de cachimbo



Art.

4903-29

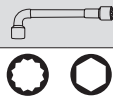

↕ 394 x 168 x 30 mm

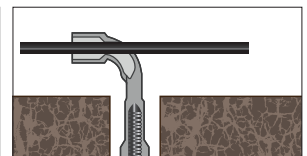
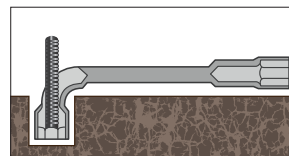



Art. 2597-07	7 mm
Art. 2597-08	8 mm
Art. 2597-09	9 mm
Art. 2597-10	10 mm
Art. 2597-11	11 mm
Art. 2597-12	12 mm
Art. 2597-13	13 mm

Art. 2597-14	14 mm
Art. 2597-15	15 mm
Art. 2597-16	16 mm
Art. 2597-17	17 mm
Art. 2597-18	18 mm
Art. 2597-19	19 mm

4
PGS

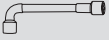
Elbow milled open wrench trays
Bandeja llaves pipa
Conjunto de chaves de cachimbo

Art.	
4903-30	

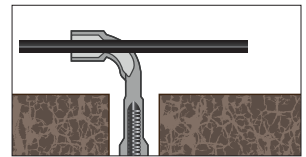
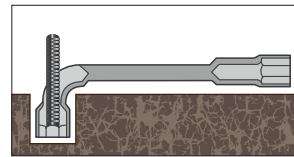

↕ 394 x 168 x 30 mm



- Art. 2597-20 20 mm
- Art. 2597-21 21 mm
- Art. 2597-22 22 mm
- Art. 2597-24 24 mm

3
PGS

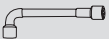
Elbow milled open wrench trays
Bandeja llaves pipa
Conjunto de chaves de cachimbo

Art.	
4903-31	

↕ 394 x 168 x 30 mm

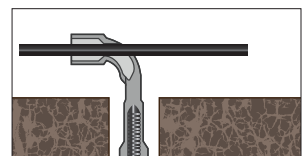
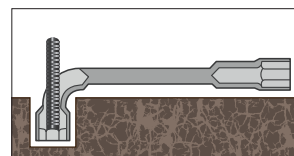

- Art. 2597-27 27 mm
- Art. 2597-30 30 mm
- Art. 2597-32 32 mm

COMPLETO EVA3 SERIE 4903

ERGOKRAFT









Screwdriver tray
Bandeja con destornilladores
Gaveta com chaves

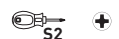

Art.
4903-09

↕ 394 x 168 x 30 mm

- | | | | |
|--|--|--|--|
|  S2 | Art. 4110-2 0.8 x 4 mm |  S2 | Art. 4112-2 1.1 x 6 mm |
| | Art. 4110-3 1.0 x 5 mm |  S2 |  + Art. 4117-2 PH 2 |
| | Art. 4110-4 1.1 x 6 mm | | |
| | Art. 4110-5 1.2 x 8 mm | | |
|  S2 |  + Art. 4115-1 PH 1 |  | Art. 2139 12 V |
| | Art. 4115-2 PH 2 | | |





Screwdriver tray
Bandeja con destornilladores
Gaveta com chaves

ERGOKRAFT



Art.
4903-10

↕ 394 x 168 x 30 mm

- | | |
|--|---|
|  S2 |  Art. 4125-08 T8 |
| | Art. 4125-10 T10 |
| | Art. 4125-15 T15 |
| | Art. 4125-20 T20 |
| | Art. 4125-25 T25 |
| | Art. 4125-27 T27 |
| | Art. 4125-30 T30 |
| | Art. 4125-40 T40 |



Impact screwdriver tray
Bandeja destornilladores de golpe

Gaveta de chaves de parafusos impacto



Art.
4903-19

↔ 394 x 168 x 30 mm



	S2		
Art. 4140-3	5.5 × 100 mm	5.5 mm	
Art. 4140-4	6.5 × 125 mm	6.5 mm	
Art. 4140-5	8.0 × 150 mm	8.0 mm	
Art. 4140-6	10.0 × 175 mm	10.0 mm	

	S2		
Art. 4145-1	PH1 × 75 mm	5.0 mm	
Art. 4145-2	PH2 × 100 mm	6.0 mm	

	S2		
Art. 4150-1	PZ1 × 75 mm	5.0 mm	
Art. 4150-2	PZ2 × 100 mm	6.0 mm	

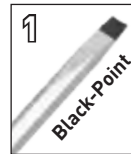

PB Swissgrip screwdriver tray
Bandeja destornilladores PB Swissgrip

Gaveta de chaves de parafusos PB Swissgrip



Art.
4903-20

↔ 394 x 168 x 30 mm

	Art. PB 8100 5	1.2 × 8 mm
	Art. PB 8100 4-140	1.0 × 6.5 mm
	Art. PB 8100 3-120	0.8 × 5.5 mm
	Art. PB 8100 2-100	0.6 × 4.0 mm
	Art. PB 8100 1- 90	0.5 × 3.5 mm

	Art. PB 8190 1- 80	PH1 × 80
	Art. PB 8190 2-100	PH2 × 100/6

	Art. PB 8451	10 × 30 mm
--	--------------	------------

	Art. PB 1750	110-250 V
--	--------------	-----------

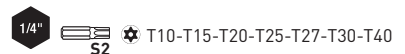

COMPLETO EVA3 SERIE 4903

S2
quality

29
PCS

Allen key tray
Bandeja de llaves acodadas
Bandeja de chave Allen



Art.

4903-27

↕ 394 x 168 x 30 mm



● Art. 3604

1.5-2-2.5-3-4-5-6-7-8-10 mm



★ Art. 3608

T10-T15-T20-T25-T27
T30-T40-T45-T50



★ Art. 3609

T10-T15-T20-T25-T27
T30-T40-T45-T50



Art. 3574 250 mm / 10" ○ 0-30 mm
DIN 3117 / ISO 6787

S2
quality

7
PCS

Ballpoint T-screwdriver tray
Bandeja destornilladores bola en T
Gaveta de chaves T sextavadas interior

ERGOKRAFT



Art.

4903-21

↕ 394 x 168 x 30 mm

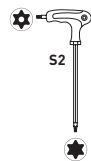

Art. 3636-3

T3

Art. 3636-4

T4

Art. 3636-5

T5

Art. 3636-6

T6

Art. 3636-7

T7

Art. 3636-8

T8

Art. 3636-10

T10

S2
quality

7
PCS

TX T-screwdriver tray
Bandeja destornilladores TX en T
Gaveta de chaves T TX

ERGOKRAFT



Art.

4903-22

↕ 394 x 168 x 30 mm

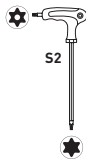

Art. 3637-10	T10
Art. 3637-15	T15
Art. 3637-20	T20
Art. 3637-25	T25
Art. 3637-27	T27
Art. 3637-30	T30
Art. 3637-40	T40

4
PCS

Hightech pliers tray
Bandeja de alicates hightech
Bandeja de alicates HIGHTECH

HIGHTECH 3C

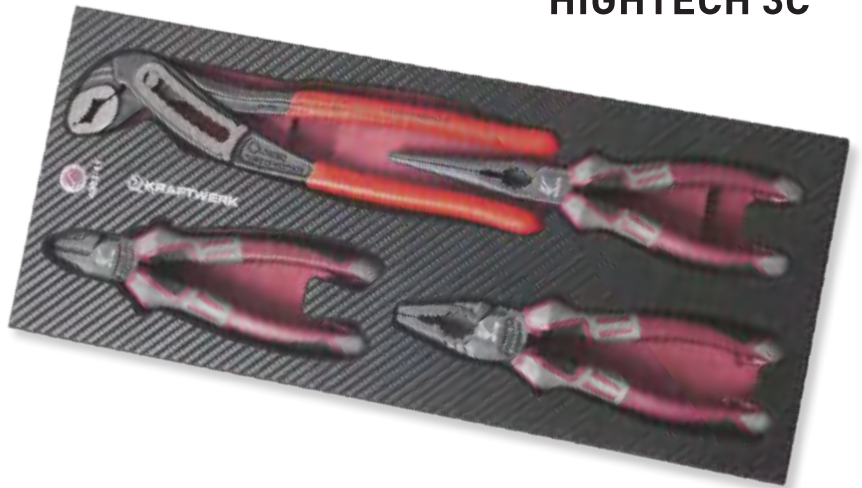

Art.

4903-15

↕ 394 x 168 x 30 mm



Art. 4271-180
DIN ISO 5746

180 mm **K C H**



Art. 4272-160
DIN ISO 5749

160 mm **K C H**



Art. 4275-205
DIN ISO 5745

205 mm **C H**



Art. 4223-240
DIN ISO 8976

240 mm

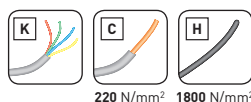

220 N/mm² 1800 N/mm²

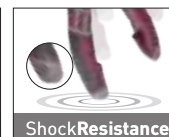
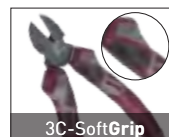

4
PCS

Pliers tray
Bandeja con alicates
Gaveta com alicates



Art.

4903-11

↕ 394 x 168 x 30 mm



Art. 3281-180 180 mm
DIN ISO 5746



Art. 3282-160 160 mm
DIN ISO 5749



Art. 3285-200 200 mm
DIN ISO 5745



Art. 3290-250 250 mm
DIN ISO 8976

4
PCS

Locking clamps/tin snip tray
Bandeja surtido tenazas
Bandeja de alicates de pressão e tesoura



Art.

4903-25

↕ 394 x 168 x 30 mm



Art. 2243 250 mm HRC 58-60



Art. 3292-175 175 mm / 7" CrMo



Art. 3292-250 250 mm / 10" CrMo



Art. 3292-150 150 mm / 6" CrMo

4
PGS

Locking clamps/tin snip tray
Bandeja surtido tenazas
Bandeja de alicates de pressão e tesoura



Art.
4903-26

↕ 394 x 168 x 30 mm



Art. 2243 250 mm HRC 58-60



Art. 3292-175 175 mm / 7" CrMo



Art. 3292-251 250 mm / 10" CrMo



Art. 3292-150 150 mm / 6" CrMo

4
PGS

Pliers/Scissor tray
Bandeja pinzas/tijeras
Bandeja de alicates/tesoura



Art.
4903-28

↕ 394 x 168 x 30 mm



Art. 3289-160C 160 mm
DIN ISO 5232



Art. 2216-200C 200 mm
DIN ISO 9343



Art. 3290-230C



Art. 2240C 150 mm

4
PCS

Circlip pliers tray
Bandeja con alicates de arandelas
Gaveta com alicates de freios



Art.

4903-12

↕ 394 x 168 x 30 mm

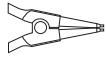

Art. 2212-A2
DIN ISO 5254A



Ø 19-60 mm

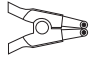

Art. 2213-A21
DIN ISO 5254B

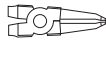

Art. 2214-J2
DIN ISO 5256C



Art. 2215-J21
DIN ISO 5256D



18
PCS

Cutting tool tray
Bandeja herramientas corte
Gaveta de ferramentas de corte



Art.

4903-23

↕ 394 x 168 x 30 mm



ERGOKRAFT

Art. 3310 9 mm



10x

Art. 3313 9 mm



ERGOKRAFT

Art. 3312 18 mm



5x

Art. 3314 18 mm



Art. 3305 300 mm

11
PGS

ERGOKRAFT





Files tray
Bandeja limas
Gaveta de limas



Art.

4903-24

↔ 394 x 168 x 30 mm

-  Art. 4320-1 320 mm
DIN 7261
-  Art. 4320-2 320 mm
DIN 7261
-  Art. 4320-3 320 mm
DIN 7261
-  Art. 4320-4 320 mm
DIN 7261
-  Art. 4320-5 320 mm
DIN 7261

|||○□◁▽ Art. 4321

11
PGS

Hammer and punch tray
Bandeja con herramientas de golpe
Gaveta com martelo e escopro





Art.

4903-13

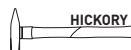
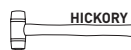
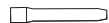
↔ 394 x 168 x 30 mm

-  **HICKORY** Art. 2305 500 g
DIN 1041
-  **HICKORY** Art. 2336 ∅ 35 mm
-  Art. 3380-18 18 mm
Art. 3380-22 22 mm
DIN 6451/53

-  Art. 1350-2 2 mm x 115 mm
Art. 1350-3 3 mm x 125 mm
Art. 1350-4 4 mm x 150 mm
Art. 1350-5 5 mm x 165 mm
Art. 1350-6 6 mm x 180 mm
Art. 1350-8 8 mm x 180 mm
DIN 6450 Form C
-  Art. 1358-2 No. 2 x 120 mm
DIN 7250

COMPLETO EVA3 SERIE 4903

AUTOMOTIVE



Impact wrench tray

Bandeja con herramienta neumática

Bandeja de chave de impacto



Art.		
4903-33	1/2"	3833
4903-34	1/2"	3834

↕ 394 x 168 x 30 mm

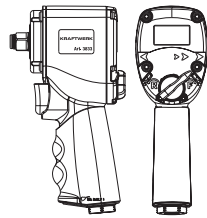

Art. 3833

1/2"	1149	920	678	9500	1500	<9.0	100.2
1.65	97	1/4"	3/8"	133	BSP	6.2	

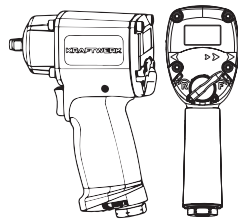

Art. 3834

1/2"	744	140-680	9000	1200	<3.6	90
1.6	125	1/4"	10	164	BSP	6.2-7



Art. 381170-0		17 mm
Art. 381190-0		19 mm
Art. 381210-0		21 mm
Art. 381220-0		22 mm
Art. 381240-0		24 mm
Art. 387125		125 mm
Art. 382100		10 mm
Art. 382120		12 mm
Art. 382130		13 mm
Art. 382140		14 mm
Art. 382150		15 mm
Art. 382170		17 mm
Art. 382190		19 mm
Art. 382210		21 mm
Art. 382220		22 mm
Art. 382240		24 mm

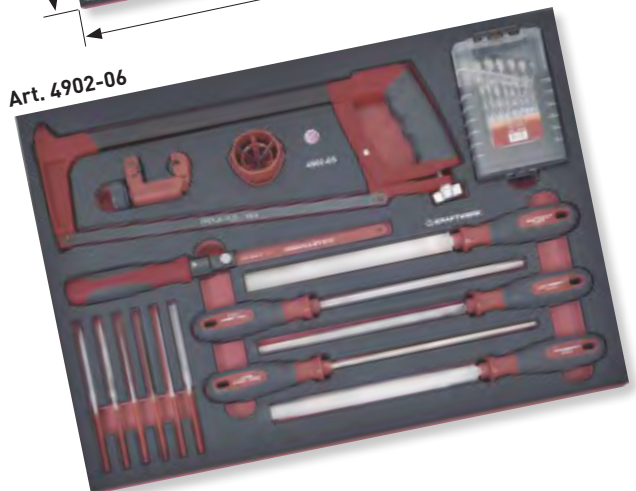
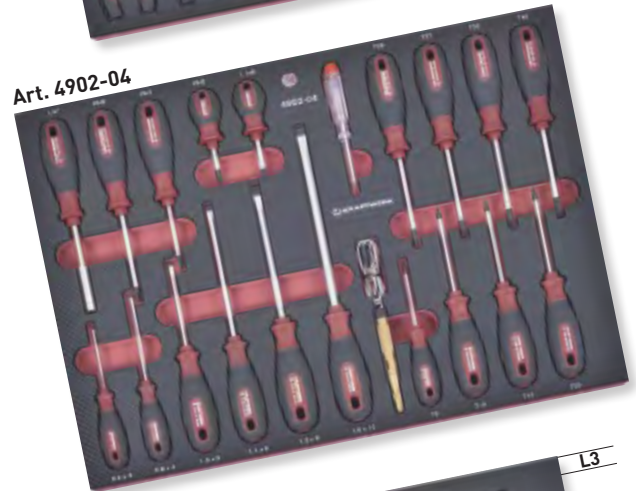

309
PGS



Tool-assortment

with professional tools, shakeproof imbedded in 6 drawers with special high density soft foam (EVA) inserts with a durable hard top lamination which can be well cleaned.

Surtido de herramientas profesionales

encastradas en 6 bandejas especiales de espuma de alta densidad (EVA) con un recubrimiento superior de plástico duro y resistente para un buen mantenimiento y limpieza.

Conjunto de ferramentas profissionais

colocadas em 6 gavetas inseridas em espuma de alta densidade (EVA) com revestimento superior que prolonga a duração e permite manter limpo.

Art.	
4917	3907-1 / 3908 / 3934 / 2907

↕ L1 527 × L2 407 × L3 30 mm

COMPLETO EVA SERIE 4902



309
PCS

Tool-assortment with tool-cabinets
Composición de herramientas con carros
Sortido de ferramentas com carros



3907-1





3908



2907



3934

Art.		
3907-4917	3907-1	6
3908-4917	3908	8
3934-4917	3934	7
2907-4917	2907	7



Socket wrench set
Bandeja llaves vasos
Conjunto de chaves de caixa

Art.
4902-01

↕ L1 527 × L2 407 × L3 30 mm



- | | | | | | |
|--|----|--|--|-----------------|--|
| | 14 | 3.5-4-4.5-5-5.5-6-7-8
9-10-11-12-13-14 mm | | 17 | 10-11-12-13-14-15-16-17-18
19-21-22-24-27-30-32-34 mm |
| | 12 | 4-4.5-5-5.5-6-7-8-9
10-11-12-13 mm | | 9 | 10-13-14-15-16-17-18
19-22 mm |
| | 3 | 4-5.5-6.5 mm | | 2 | 16 mm / 21 mm |
| | 3 | PH 1-2-3 | | | □ 1/2" □ 1/2" |
| | 3 | PZ 1-2-3 | | 2 | 125 mm / 250 mm |
| | 8 | T8-T10-T15-T20
T25-T27-T30-T40 | | | ○ 3/8" □ 1/2" |
| | 6 | 3-4-5-6-7-8 mm | | | ○ 1/2" ○ 5/16" |
| | | ○ 1/4" ○ 1/4" | | (60) Art. 4020B | |
| | | ○ 1/4" □ 1/4" | | | +Nm |
| | 2 | 50 mm / 100 mm | | | |
| | | 150 mm | | | |
| | | 105 mm | | | |
| | | ○ 1/4" □ 1/4" | | | |
| | | ● 1/4" □ 1/4" | | | |

- | | | | | | |
|--|----------------|--|-----------------|--|-----|
| | (72) Art. 3799 | | (60) Art. 4000B | | +Nm |
|--|----------------|--|-----------------|--|-----|

- | | | |
|--|---|------------------------------------|
| | 6 | 4-4.5-5.5-6-6.5-8 mm |
| | 4 | PH 1-2-3-4 |
| | 4 | PZ 1-2-3-4 |
| | 8 | T8-T10-T15-T20-T-25-T27-T30-T40 |
| | 8 | T8-T10-T15-T20-T-25-T27-T30-T40 |
| | 6 | 3-4-5-6-7-8 mm |
| | 6 | 2-2.5-3-4-5-6 mm |
| | 6 | 5/64"-3/32"-7/64"-1/8"-9/64"-5/32" |
| | 3 | Nos. 6-8-10 |
| | 4 | Nos. 1-2-3-4 |
| | 4 | Nos. 4-6-8-10 |

1/4" 1/4" 1/4" 1/4"

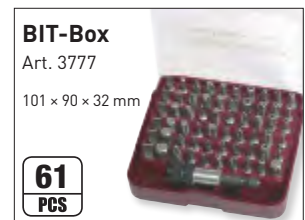
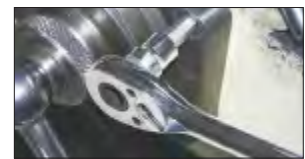

45
PCS

Spanner and torque wrench set

Bandeja llaves combinadas y llave dinamoétrica

Conjunto de chaves de boca-luneta e chave dinamoétrica

Art.

4902-02

↔ L1 527 × L2 407 × L3 30 mm

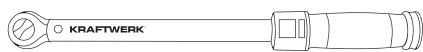

Art. 3235 C 1/2" 40-200 Nm / 30-150 Lb.ft



DIN 2936 S2 1.5-2-2.5-3-4-5-6-7-8-10 mm



XXL S2 T10-T15-T20-T25-T27-T30-T40-T45-T50

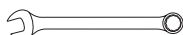

DIN 3113

Art. 3505	5.5 mm	Art. 3511	11 mm	Art. 3517	17 mm	Art. 3523	23 mm
Art. 3506	6 mm	Art. 3512	12 mm	Art. 3518	18 mm	Art. 3524	24 mm
Art. 3507	7 mm	Art. 3513	13 mm	Art. 3519	19 mm	Art. 3527	27 mm
Art. 3508	8 mm	Art. 3514	14 mm	Art. 3520	20 mm	Art. 3530	30 mm
Art. 3509	9 mm	Art. 3515	15 mm	Art. 3521	21 mm	Art. 3532	32 mm
Art. 3510	10 mm	Art. 3516	16 mm	Art. 3522	22 mm		



ERGOKRAFT

DIN 3117 / ISO 6787

Art. 3572 150 mm / 6"
Art. 3573 200 mm / 8"

13
PCS

Pliers set

Bandeja alicates

Conjunto de alicates

Art.

4902-03

↔ L1 527 × L2 407 × L3 30 mm



Art. 3281-180 180 mm
DIN ISO 5746



Art. 3282-140 140 mm
Art. 3282-160 160 mm
DIN ISO 5749

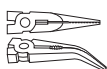

Art. 3285-200 200 mm
Art. 3286-200 200 mm/45°
DIN ISO 5745



Art. 3289-160 160 mm
DIN ISO 5232



Art. 2221-250 250 mm
DIN ISO 8976



Art. 2240 180 mm
ERGOKRAFT



Art. 2212-A2 A2
DIN ISO 5254A



Art. 2213-A21 A21
DIN ISO 5254B



Ø 19-60 mm



Art. 2214-J2 J2
DIN ISO 5256C



Art. 2215-J21 J21
DIN ISO 5256D

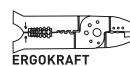

Art. 3290-230 230 mm
1.5 - 6 mm² 1.5 - 4-6 mm²

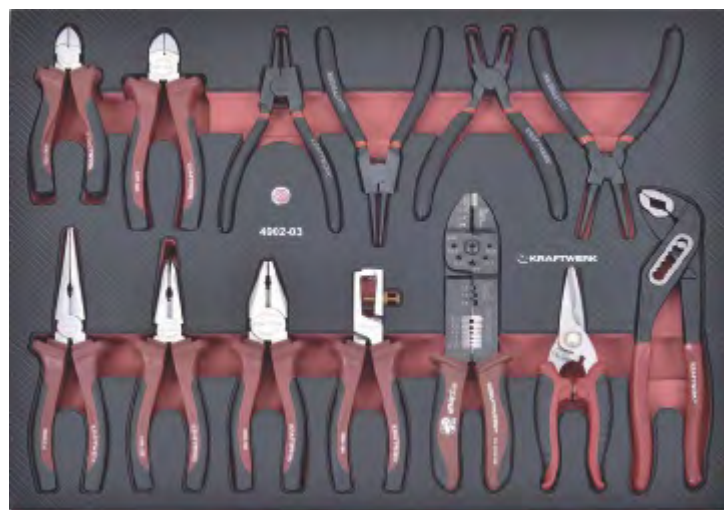









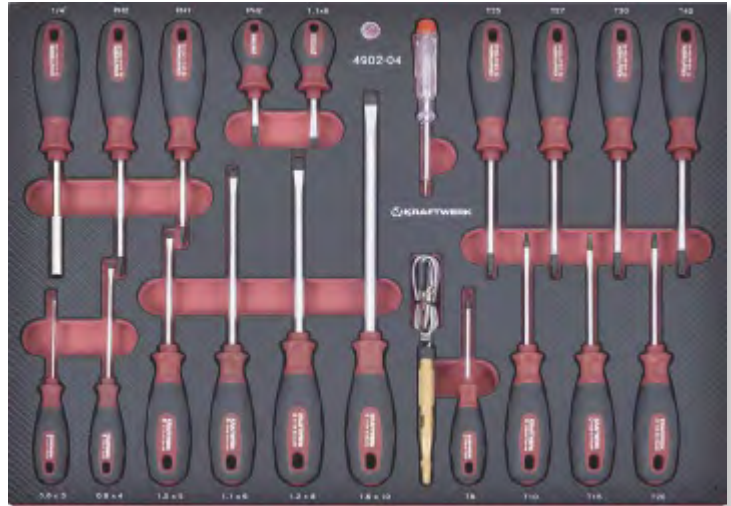

Screwdriver set
Bandeja destornilladores
Conjunto de chaves de parafusos

Art.
4902-04

↕ L1 527 × L2 407 × L3 30 mm



- | | | | | | |
|--|-------------------------|--|------------------|---|---------------------|
|  S2 | Art. 4110-1 0.6 × 3 mm |  S2 | Art. 4117-2 PH2 |  | Art. 2138 100-250 V |
| | Art. 4110-2 0.8 × 4 mm |  S2 | Art. 4125-08 T8 |  | Art. 2139 12 V |
| | Art. 4110-3 1.0 × 5 mm | | Art. 4125-10 T10 | | |
| | Art. 4110-4 1.1 × 6 mm | | Art. 4125-15 T15 | | |
| | Art. 4110-5 1.2 × 8 mm | | Art. 4125-20 T20 | | |
| | Art. 4110-6 1.6 × 10 mm | | Art. 4125-25 T25 | | |
|  S2 | Art. 4115-1 PH1 | | Art. 4125-27 T27 | | |
| | Art. 4115-2 PH2 | | Art. 4125-30 T30 | | |
| | | | Art. 4125-40 T40 | | |
|  S2 | Art. 4112-2 1.1 × 6 mm |  | Art. 4128 1/4" | | |











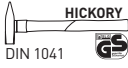



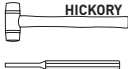
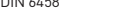















Striking/cutting and measuring tool set
Bandeja herramientas golpe/medición
Conjunto de percussão e de medição/corte

Art.
4902-05

↕ L1 527 × L2 407 × L3 30 mm



- | | | | | | | | |
|--|-------------------|---|--------------------|--|-----------------------------|---|----------------------------|
|  HICKORY
DIN 1041 | Art. 2303 300 g |  | Art. 1355-2 2 mm |  | Art. 3196 130-630 mm 2000 g |  | Art. 3312 18 mm |
|  HICKORY | Art. 2336 Ø 35 mm |  | Art. 1355-3 3 mm |  | Art. 32065 |  | Art. 3314 18 mm |
|  | Art. 1350-2 2 mm |  | Art. 1355-4 4 mm |  | Art. 2976 |  | Art. 2972 150 mm × 0.01 mm |
|  | Art. 1350-3 3 mm |  | Art. 1355-5 5 mm |  | Art. 3310 9 mm |  | DIGITAL 6" × 0.0005" |
|  | Art. 1350-4 4 mm |  | Art. 1355-6 6 mm |  | Art. 3313 9 mm |  | 3 m × 16 m |
|  | Art. 1350-5 5 mm |  | Art. 1358-1 No. 1 | | | | |
|  | Art. 1350-6 6 mm |  | Art. 1358-2 No. 2 | | | | |
|  | Art. 1350-8 8 mm |  | Art. 3380-18 18 mm |  | | | |
| | |  | Art. 3380-22 22 mm |  | | | |









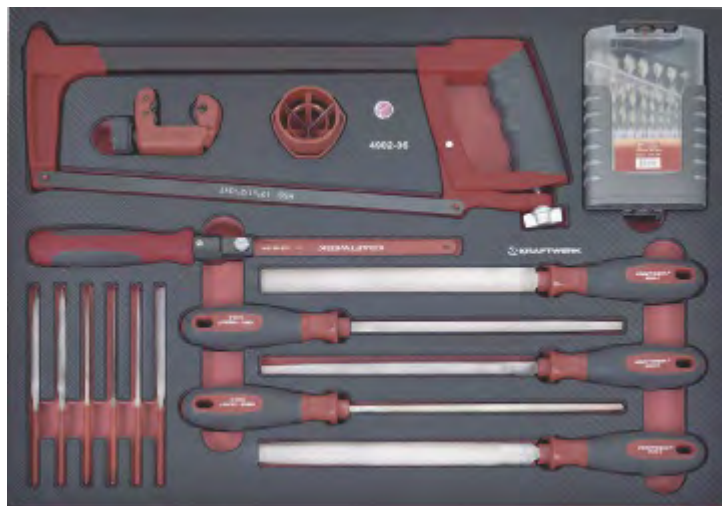

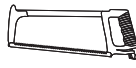

35
PCS

File, saw and drill bit set
Bandeja limas y brocas
Conjunto de limas, de serras e de brocas

Art.
4902-06

↕ L1 527 × L2 407 × L3 30 mm

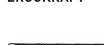

- | | | | | | |
|--|--------------------------------|--|-------------------------------------|---|---|
|  | Art. 4320-1 320 mm
DIN 7261 |  | Art. 4321 |  | Art. 11904 1-1.5-2-2.5-3
DIN 338 N 3.5-4-4.5-5-5.5
6-6.5-7-7.5-8
8.5-9-9.5-10 mm |
|  | Art. 4320-2 320 mm
DIN 7261 |  | Art. 3305 300 mm |  | Art. 5433 3-30 mm CU |
|  | Art. 4320-3 320 mm
DIN 7261 |  | Art. 3308-1 |  | Art. 5470 Ø 4-40 cm |
|  | Art. 4320-4 320 mm
DIN 7261 |  | Art. 3316-24 300 mm
HSS-Bimetall | | |
|  | Art. 4320-5 320 mm
DIN 7261 | | | | |

12
PCS

T-type universal socket set
extra long
Bandeja multillas con vaso extra largo
Conjunto de chaves de caixa em "T" longa

Art.
4902-07

↕ L1 527 × L2 407 × L3 30 mm



-  **XXL** DIN 896 / ISO 2236, 1085
- | | |
|--------------------|--------------------|
| Art. 2592-08 8 mm | Art. 2592-14 14 mm |
| Art. 2592-09 9 mm | Art. 2592-15 15 mm |
| Art. 2592-10 10 mm | Art. 2592-16 16 mm |
| Art. 2592-11 11 mm | Art. 2592-17 17 mm |
| Art. 2592-12 12 mm | Art. 2592-18 18 mm |
| Art. 2592-13 13 mm | Art. 2592-19 19 mm |

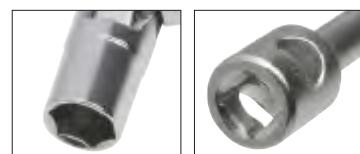



21
PCS

Heavy duty socket wrench set
with fine tooth ratchet handle and socket
quick release function and extension bars
with locking system

**Bandeja industrial de llaves
de vaso**

con carraca dentado fino con función
de extracción rápida y alargadera con
sistema de bloqueo

**Jogo de chaves de caixa "Heavy
duty"**

com roquete de dentes finos com meca-
nismo de ejección de chaves e extensões
com sistema de segurança.



Art.

4902-08

↕ L1 527 × L2 407 × L3 40 mm



16 19-21-22-23-24-26-27-29-30
32-35-36-38-41-46-50 mm

3 100-200-400 mm

460 mm



22
PCS

Heavy duty socket wrench set
with digital torque adapter

**Bandeja industrial de llaves
de vaso**

con adaptador dinamométrico
electrónico

**Jogo de chaves de caixa
"Heavy duty"**

com adaptador electrónico torque



Art.

4902-080

4081-34

4902-081

4081-341

↕ L1 527 × L2 407 × L3 40 mm



16 19-21-22-23-24-26-27-29-30
32-35-36-38-41-46-50 mm

3 100-200-400 mm

460 mm

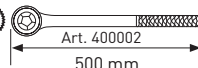

0 / Art. 4081-34



Art. **4081-34**
100-500 Nm (± 2%) / 73.8-369 Lb.ft
kg-m / kg-cm / lb-in / ft-lbs

4902-081 / Art. 4081-341

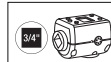

Art. **4081-341**
200-1000 Nm (± 2%) / 147.6-738 Lb.ft
kg-m / kg-cm / lb-in / ft-lbs

COMPLETO EVA SERIE 4902



Heavy duty socket wrench set
with extensible/telescope fine tooth
ratchet handle and socket quick release
function and extension bars with locking
system

Bandeja industrial de llaves de vaso

con carraca de dentado fino con mango
telescopico/extensible con función de
extracción rápida y alargadera con
sistema de bloqueo

Jogo de chaves de caixa "Heavy duty"

com roquete **extensível** de dentes finos
com mecanismo de ejeção de chaves
e extensões com sistema de segurança



Art.
4902-09

↕ L1 527 × L2 407 × L3 40 mm

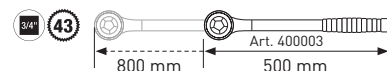

- 16 19-21-22-23-24-26-27-29-30
32-35-36-38-41-46-50 mm
- 3 100-200-400 mm
- 460 mm



Heavy duty socket wrench set
with digital torque adapter

Bandeja industrial de llaves de vaso

con adaptador **dinamométrico electrónico**

Jogo de chaves de caixa "Heavy duty"

com adaptador electrónico torque



Art.	
4902-090	4081-34
4902-091	4081-341

↕ L1 527 × L2 407 × L3 40 mm

- 16 19-21-22-23-24-26-27-29-30
32-35-36-38-41-46-50 mm

3 100-200-400 mm

460 mm

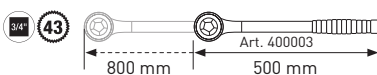

4902-090 / Art. 4081-34

Art. 4081-34
100-500 Nm (± 2%) / 73.8-369 Lb.ft
kg-m / kg-cm / lb-in / ft-lbs

4902-091 / Art. 4081-341

Art. 4081-341
200-1000 Nm (± 2%) / 147.6-738 Lb.ft
kg-m / kg-cm / lb-in / ft-lbs



Art. 4919-01



Art. 4919-02



Art. 4919-03

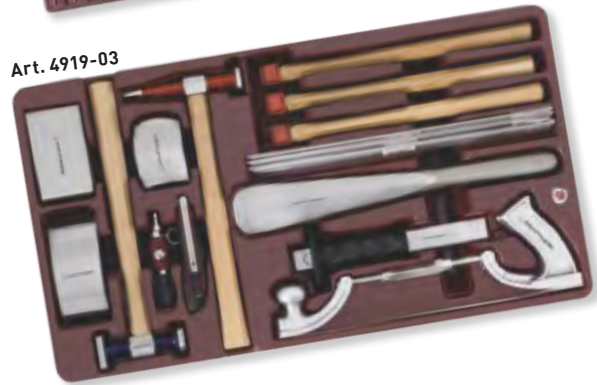

Service workshop trolley



with tools

Carro taller

con herramientas

Carro multiuso

com ferramentas

Art.			PCS
3917-4919	3917	4919-01, 4919-02	160

Body workshop trolley



universal composition with a set of special body repair tools in the 3rd drawer.

Carro para taller de carrocería

con herramientas universales y con un juego de herramienta especial para taller de carrocería en el tercer cajón.

Carro de ferramentas para oficina de carroçaria

fornecido com ferramentas universais e com um conjunto de ferramentas especiais para bate-chapas na terceira gaveta.

Art.			PCS
3917-4919+3	3917	4919-01, 4919-02, 4919-03	176

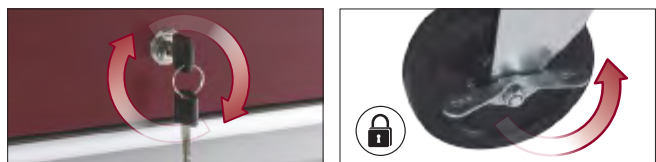

Spanner and socket tray
Bandeja vasos y llaves
Bandeja de chaves de caixa



132
PCS

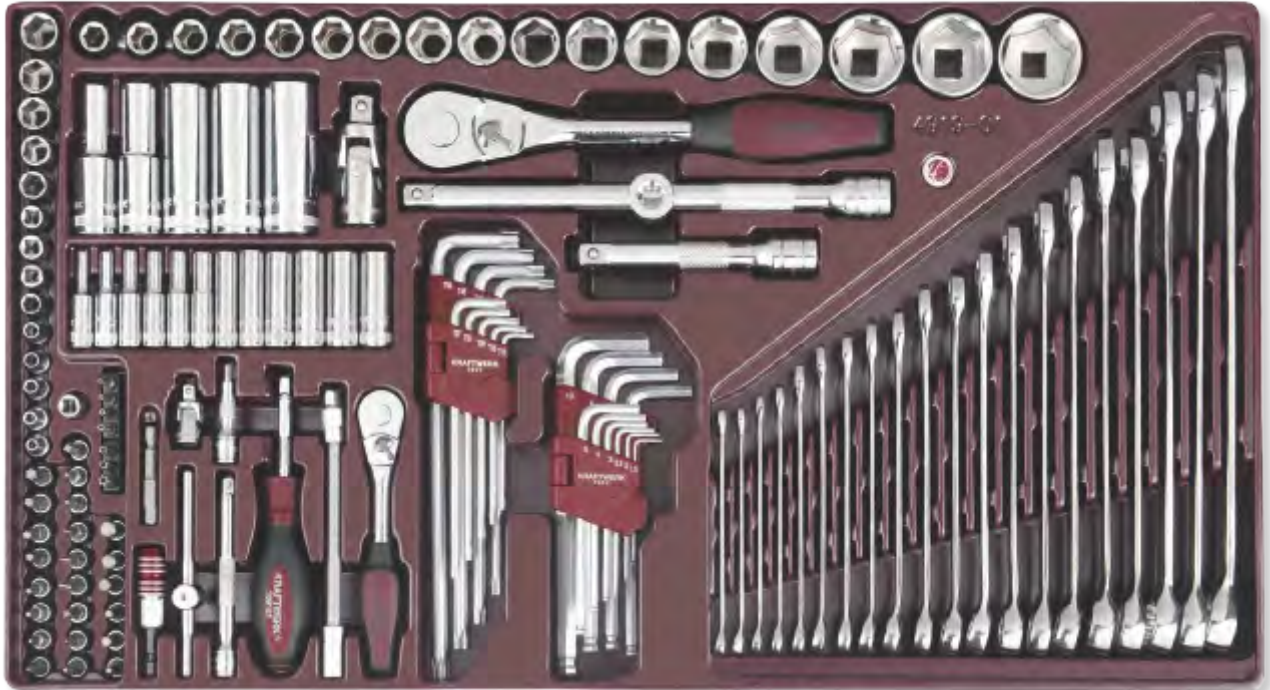

- 14 3.5-4-4.5-5-5.5-6-7-8-9-10-11-12-13-14 mm
- 12 4-4.5-5-5.5-6-7-8-9-10-11-12-13 mm
- 3 4-5.5-6.5 mm
- 3 PH 1-2-3
- 3 PZ 1-2-3
- 8 T8-T10-T15-T20-T25-T27-T30-T40
- 6 3-4-5-6-7-8 mm
- 1/4" 1/4"
- 1/4" 1/4"
- 2 50 mm / 100 mm
- 150 mm
- 115 mm
- 1/4" 1/4"
- 7 T10-T15-T20-T25-T27-T30-T40
- 1/4" 1/4"
- 1/4" 1/4"
- Art. 3200

- 17 10-11-12-13-14-15-16-17-18
19-21-22-24-27-30-32-34 mm
- 5 10-13-17-19-22 mm
- 1/2" 1/2"
- 2 125 mm / 250 mm
- 3/8" 1/2"
- Art. 3220
- Art. 3602
DIN 2936 S2 1.5-2-2.5-3-4-5-6-7-8-10 mm
- Art. 3607
XXL S2 T10-T15-T20-T25-T27
T30-T40-T45-T50

- DIN 3113
- Art. 3505 5.5 mm
- Art. 3506 6 mm
- Art. 3507 7 mm
- Art. 3508 8 mm
- Art. 3509 9 mm
- Art. 3510 10 mm
- Art. 3511 11 mm
- Art. 3512 12 mm
- Art. 3513 13 mm
- Art. 3514 14 mm
- Art. 3515 15 mm
- Art. 3516 16 mm
- Art. 3517 17 mm
- Art. 3518 18 mm
- Art. 3519 19 mm
- Art. 3520 20 mm
- Art. 3521 21 mm
- Art. 3522 22 mm
- Art. 3523 23 mm
- Art. 3524 24 mm

Art.

4919-01

Screwdriver, pliers and striking tools tray

Bandeja destornilladores, alicates y herramientas de golpe

Bandeja de chaves de parafusos, alicates e ponteiros

28
PCS



DIN ISO 5746
Art. 3281-180 180 mm



DIN ISO 5745
Art. 3285-200 200 mm



Art. 1350-2 2 mm
DIN 6450 Form C Art. 1350-3 3 mm
Art. 1350-4 4 mm
Art. 1350-5 5 mm
Art. 1350-6 6 mm
Art. 1350-8 8 mm



DIN ISO 5749
Art. 3282-160 160 mm



DIN ISO 5232
Art. 3289-160 160 mm



DIN ISO 8976
Art. 3290-250 250 mm

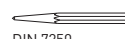

Art. 1358-2 No. 2
DIN 7250



Art. 4110-1 0.6 x 3 mm
S2 Art. 4110-2 0.8 x 4 mm
Art. 4110-3 1.0 x 5 mm
Art. 4110-4 1.1 x 6 mm
Art. 4110-5 1.2 x 8 mm

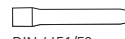

Art. 3380-18 18 mm
DIN 6451/53 Art. 3380-22 22 mm

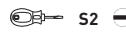

S2 Art. 4112-2 1.1 x 6 mm

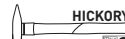

HICKORY Art. 2305 500 g
DIN 1041



Art. 4115-1 PH1
S2 Art. 4115-2 PH2

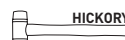

HICKORY Art. 2336 Ø 35 mm

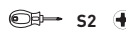

S2 Art. 4117-2 PH2



3 m x 16 m



Art. 2138 100-250 V



Art. 2139 12 V

Art.

4919-02

Bodywork tool tray

Bandeja con herramientas para taller de carrocería





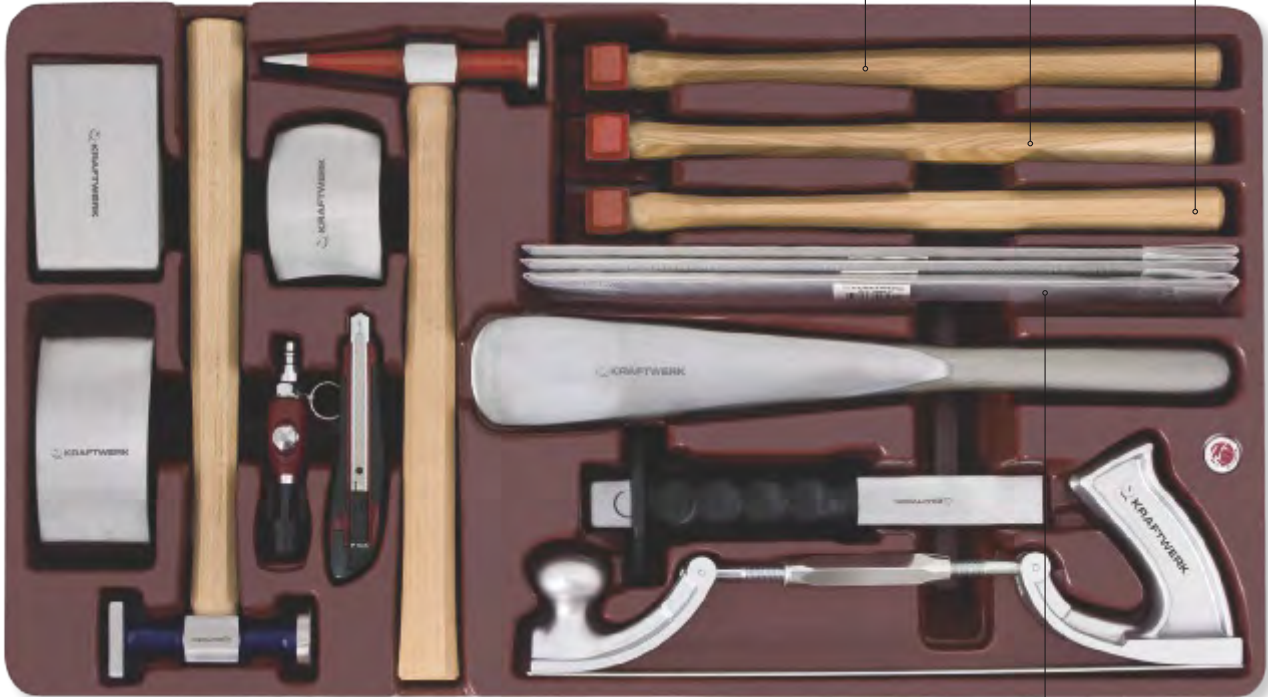

Gaveta com ferramentas para oficina de carroçaria

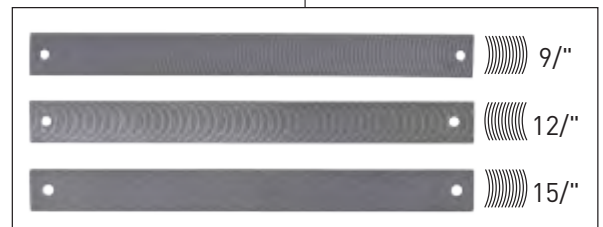
16
PCS

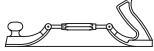

- | | | |
|---|---|--|
|  | 1 | Wedge dolly
<i>Tas cuña</i>
Encontrador punta |
|  | 1 | Curved dolly
<i>Tas coma</i>
Encontrador virgula |
|  | 1 | High crowned dolly
<i>Tas americano</i>
Encontrador curvo |
|  | 1 | Planishing hammer
<i>Martillo combi para desabollar y alisar.</i>
Martelo plano faces polidas |
|  | 1 | Bumping hammer
<i>Martillo combi con bola para desabollar y alisar.</i>
Martelo cabeça redonda plana e ponta |
|  | 1 | Bumping and planishing hammer serrated face
<i>Martillo acanalado para desabollar y alisar.</i>
Martelo plano serrilha |
|  | 1 | Bumping and planishing hammer flat face
<i>Matillo cabeza plana para desabollar y alisar.</i>
Martelo plano liso |
|  | 1 | Bumping and planishing hammer bowed face
<i>Martillo cabeza abombada</i>
Martelo plano angular |



- | | | |
|--|---|--|
|  | 1 | Car body file holder 350 mm
<i>Lima carrocero 350 mm</i>
Lima de Bate-chapas 350 mm |
|  | 3 | Car body file blade
<i>Hoja angular para lima carrocero</i>
Lima radial de bate-chapas |
|  | 1 | Car body spoon
<i>Cuchara carrocero</i>
Colher de bate-chapas |
|  | 1 | Car body chisel
<i>Buril carrocero</i>
Cinzel com punho |
|  | 1 | Mini air blow gun with turbo power nozzle
<i>Mini sopladora con efecto turbo.</i>
Mini soprador turbo. |
|  | 1 | Snap-Off Knife
<i>Cúter</i>
X-acto |

Art.

4919-03

Multipurpose shelf trolley

- 3 big shelves, made of polypropylene and fibreglass
- Very solid construction for universal use, aluminium rods
- 4 swivel castors Ø 100 mm, 2 of them with brakes
- Shelf capacity: 80 kg
- Trolley capacity: 160 kg

Mesa de trabajo móvil

- 3 grandes baldas en polipropileno y fibra de vidrio
- construcción muy sólida para uso universal, barras en aluminio
- ruedas giratorias Ø 100 mm, 2 con freno
- capacidad por bandeja: 80 kg
- capacidad total: 160 kg

Carro multiuso de prateleiras

- 3 prateleiras grandes em polipropileno e fibra de vidro
- Construção sólida para uso universal, hastes de alumínio
- 4 rodízios giratórios Ø 100 mm, 2 deles com travão
- Capacidade da prateleira: 80 kg
- Capacidade do carro: 160 kg



Art.

3912

	L1 / mm	L2 / mm	L3 / mm	⚖️ kg
	910	480	1040	320
A	660	390	300	160
B	660	390	300	80

Multipurpose shelf trolley

with accessory kit for transporting windows and windshields.

Mesa de trabajo móvil

con kit de accesorios para el transporte de las ventanillas y parabrisas.

Carro multiuso de prateleiras

com kit de acessórios para o transporte de janelas e pára-brisas.



Art.



x4

3912A

3912

3912-98



Waste bin

for multipurpose shelf trolley 3912
made of oil and acid resistant polypropylene

Cubo de basura

para mesa de trabajo móvil 3912
en polipropileno, resistente al aceite y a los ácidos

Caixote do lixo

para carro multiuso de prateleiras 3912
em polipropileno, resistentes ao óleo e ao ácido

Art.	
3912-99	3912

↕ L1 360 × L2 250 × L3 430 mm



19L

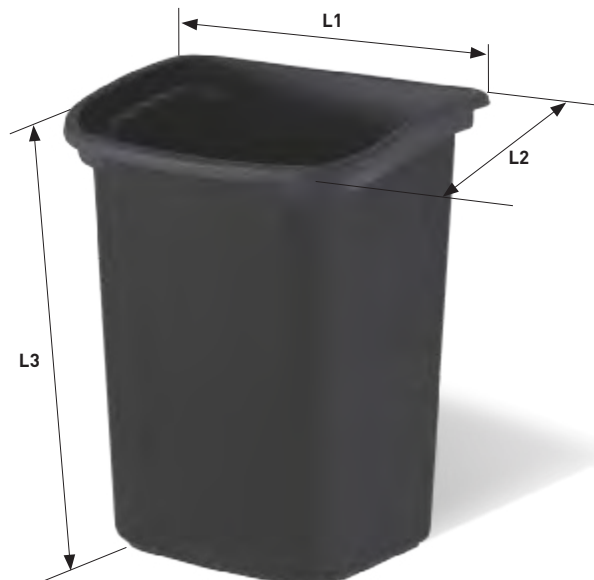









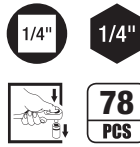





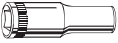

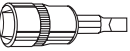

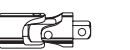

HIGHTECH Professional socket wrench case

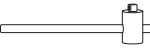
Estuche llaves de vaso profesional universal HIGHTECH

Mala HIGHTECH Professional com roquete



HIGHTECH FINE POWER





















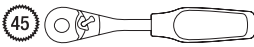

-   14 ○ 3.5-4-4.5-5-5.5-6-7-8
9-10-11-12-13-14 mm
-  12 ○ 4-4.5-5-5.5-6-7-8
9-10-11-12-13 mm
-  7 ☆ E4-E5-E6-E7-E8-E10-E11
-  3 ○ 4-5.5-6.5 mm
-  3 + PH 1-2-3
-  3 + PZ 1-2-3
-  8 ☆ T8-T10-T15-T20-T25-T27-T30-T40
-  6 ● 3-4-5-6-7-8 mm
-  6 ● M4-M5-M6-M7-M8-M10
-  ○ 1/4" ○ 1/4"
-  ○ 1/4" ■ 1/4"
-  2 50 mm / 100 mm
-  150 mm
-  110 mm
-  ○ 1/4" ■ 1/4"
-  120 Art. 4001 
-   7 ☆ T10-T15-T20-T25-T27-T30-T40
-  ● 1/4" ■ 1/4"





↕ 300 x 190 x 60 mm

Art.	○	●
4007	1/4"	1/4"

The classic of KRAFTWERK
Socket wrench case
El clásico de KRAFTWERK
Juego de llaves de vaso
O clássico da KRAFTWERK
Jogo de chaves de caixa

-   14 3.5-4-4.5-5-5.5-6-7-8-9-10-11-12-13-14 mm
-   1/4"  1/4"
-   1/4"  1/4"
-  100 mm
-   1/4"
-  Art. 3200
-   2  5.5-6.5 mm
-  2  PH 1-2
-  2  PZ 1-2
-  6  T10-T15-T20-T25-T30-T40
-  5  3-4-5-6-8 mm

Art.		
3005	1/4"	1/4"























 194 x 133 x 35 mm



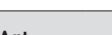

The most compact 1/4" drive set of the world!
All-purpose socket wrench set
 with 72 fine teeth ratchet handle with special small and flat head
 in solid mini-ABS-case.

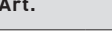
El juego de 1/4" más compacto del mundo!
Juego de llaves de vaso multiuso
 con carraca 72 dientes en mini estuche sólido en ABS.

O jogo de 1/4" mais completo do mundo!
Jogo de chaves de caixa multiuso
 com roquete de 72 dentes finos, cabeça compacta numa caixa
 de ABS sólida.

-   14 3.5-4-4.5-5-5.5-6-7-8-9-10-11-12-13-14 mm
-   1/4"  1/4"
-   1/4"  1/4"
-  50 mm
-  Art. 4009
-   3  4-4.5-5.5 mm
-  3  PH 1-2-3
-  3  PZ 1-2-3
-  8  T8-T10-T15-T20-T25-T27-T30-T40
-  5  3-4-5-6-8 mm

Art.		
4033	1/4"	1/4"



 163 x 80 x 35 mm



Socket wrench case
Estuche de llaves de vaso
Mala de chaves de caixa



COMPLETO

- 14 3.5-4-4.5-5-5.5-6-7-8-9-10-11-12-13-14 mm
- 12 4-4.5-5-5.5-6-7-8-9-10-11-12-13 mm
- 3 4-5-5-6.5 mm
- 3 PH 1-2-3
- 3 PZ 1-2-3
- 8 T8-T10-T15-T20-T25-T27-T30-T40
- 6 3-4-5-6-7-8 mm
- 1/4" 1/4"
- 1/4" 1/4"
- 2 50 mm / 100 mm
- 150 mm
- 115 mm
- 1/4"
- 45 Art. 3200
- 7 T10-T15-T20-T25-T27-T30-T40
- 1/4" 1/4"
- 1/4" 1/4"



421 x 200 x 68 mm

Art.		
4900-01K	1/4"	1/4"

Socket wrench set
in solid metal case
Juego de llaves de vaso
en estuche sólido metálico
Jogo de chaves de caixa
em caixa metálica



- 12 4-4.5-5-5.5-6-7-8-9-10-11-12-13 mm
- 1/4" 1/4"
- 1/4" 1/4"
- 50 mm
- 3/8" 1/4"
- 1/4"
- 3 1.5-2-2.5 mm
- 45 Art. 3200



245 x 130 x 40 mm

Art.		
2003	1/4"	1/4"



- 5 3-4-5-6-8 mm
- 3 4-5.5-6.5 mm
- 2 PH 1-2
- 2 PZ 1-2
- 7 T10-T15-T20-T25-T27-T30-T40

COMBI socket wrench set

in solid 2-component box

Juego de llaves de vaso COMBI

en caja sólida bi-material

Jogo de chaves de caixa COMBI

em caixa sólida de 2 componentes

- 1/4"  13
- mm** 4-4.5-5-5.5-6-7-8-9-10-11-12-13-14 mm
- inch** 5/32"-7/32"-1/4"-5/16"-11/32"
3/8"-7/16"-15/32"-1/2"-9/16"
- TX** E5-E6-E8-E10-E12-E14-E16-E18
- XZN** M5-M6-M8-M10-M12-M14-M16-M18

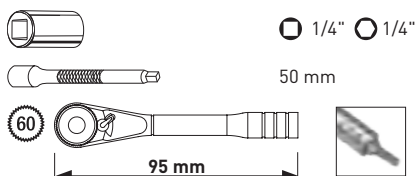

- 1/4"  S2
- 2  4-5.5 mm
- 2  PH 1-2
- 2  PZ 1-2
- 4  T15-T20-T25-T30
- 2  3-4 mm

Art.	○	●
4004	1/4"	1/4"

COMBI socket wrench set

with finger ratchet handle

Juego de llaves de vaso COMBI







con pomo con carraca

Jogo de chaves de caixa COMBI

com roquete de uma mão

- 1/4"  6
- mm** 4-5-6-8-10-13 mm
- inch** 5/32"-3/16"-5/16"-3/8"-1/2"
- TX** E5-E8-E10-E12
- XZN** M5-M6-M8-M10-M12-M16



- 1/4"  S2
- 2  5.5-6.5 mm
- 2  PH 1-2
- 2  PZ 1-2
- 6  T10-T15-T20-T25-T30-T40
- 4  3-4-5-6 mm

Art.	○	●
38005	1/4"	1/4"



165 x 85 x 35 mm

ABS



Socket wrench and bit set















in stainless steel

Juego de llaves de vaso y puntas



en acero inoxidable

Jogo de chaves de caixa e bits

em aço inox

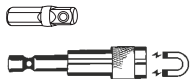
-   13 4-4.5-5-5.5-6-7-8-9
10-11-12-13-14 mm
 -   2  4-5.5-6.5 mm
 - 4  PH1 - 2x PH2 - PH3
 - 4  PZ1 - 2x PZ2 - PZ3
 - 7  T10-T15-T20-T25-T27-T30-T40
 - 7  T10-T15-T20-T25-T27-T30-T40
 - 5  3-4-5-6-8 mm
-  1/4"  1/4"
-  1/4"  1/4"



Art.		
4003	1/4"	1/4"

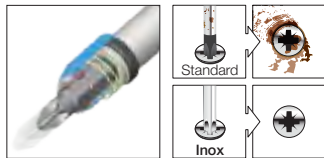

inox



 165 x 85 x 35 mm

INOX-tools – to avoid external rust

Herramientas en acero inoxidable para evitar el óxido externo





















Ferramentas aço INOX para evitar ferrugem externa



ABS

Socket wrench set

Juego de llaves de vaso

Jogo chaves caixa

-   10 5.5-6-7-8-9-10
11-12-13-14 mm
-   1/4"  1/4"
-   1/4"  1/4"
-   1/4"
-  2 50 / 100 mm
-  
-    4  3-4-5-6 mm
- 4  PH1 - 2x PH2 - PH3
- 2  PZ1-PZ2-PZ3
- 7  T10-T15-T20-T25-T27-T30-T40
- 4  3-4-5-6 mm

Art.		
99073	1/4"	1/4"



 197 x 90 x 50 mm

Socket wrench set

in solid metal case with hard plastic edge protection.































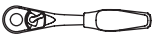













Juego de llaves de vaso

en estuche metálico con bordes de protección en plástico.

Conjunto de chaves

em caixa metálica com cantos protectores em plástico endurecido.





- 

14

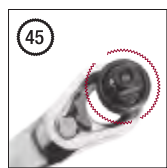
3.5-4-4.5-5-5.5-6-7-8
9-10-11-12-13-14 mm
- 
5

5.5-7-8-10-13 mm
- 
 1/4"  1/4"
- 
 1/4"  1/4"
- 
 1/4"  1/4"
- 
2
50 mm / 100 mm
- 
150 mm
- 
 1/4"  1/4"
- 

Art. 3200

- 

3

4-5.5-6.5 mm
- 

3

PH 1-2-3
- 

3

PZ 1-2-3
- 

8

T8-T10-T15-T20-T25-T27-T30-T40
- 

6

3-4-5-6-7-8 mm
- 

7

T10-T15-T20-T25-T27-T30-T40
- 
4

1.27-1.5-2-2.5 mm
- 
 1/4"  1/4"



288 x 137 x 48 mm



Art.		
2004	1/4"	1/4"

HIGHTECH Professional socket wrench case

Estuche llaves de vaso profesional universal HIGHTECH

Mala HIGHTECH Professional com roquete



HIGHTECH FINE POWER



- 18 6-7-8-9-10-11-12-13-14-15
16-17-18-19-20-21-22-24 mm
- 10 10-11-12-13-14-15-17-18-19-22 mm
- 4 14-16-18-21 mm
- 12 E4-E5-E6-E7-E8-E10-E11
E12-E14-E16-E18-E20
- 12 T8-T10-T15-T20-T25-T27
T30-T40-T45-T50-T55-T60
- 7 3-4-5-6-7-8-10 mm
- 3/8" 5/16"
- 3/8" 1/4"
- 3/8" 3/8"
- 75 mm / 250 mm
- 1/2" 3/8"
- Art. 4011
- 5 5.5-6.5-8-10-12 mm
- 4 PH 1-2-3-4
- 4 PZ 1-2-3-4
- 12 T10-T15-T20-T25-T27-T30
T40-T45-T50-T55-T60-T70
- 5 M5-M6-M8-M10-M12
- 1/4" 3/8"



400 x 290 x 80 mm

Art.		
4017	3/8"	5/16"

Socket wrench set











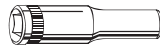

in solid metal case

Juego de llaves de vaso

en estuche sólido metálico

Jogo de chaves de caixa

em caixa metálica

		15	6-7-8-9-10-11-12-13-14 15-16-17-18-19-22 mm
		4	10-13-17-19 mm
		2	16 mm / 21 mm
			□ 3/8" ○ 1/4"
			□ 3/8" ■ 3/8"
		2	75 mm / 250 mm
			○ 1/2" ■ 3/8"
		Art. 3210	
		4	⊖ 4-5-5-6.5-8 mm
		3	⊕ PH 1-2-3
		3	⊕ PZ 1-2-3
		7	⊕ T10-T15-T20-T25-T27-T30-T40
		6	● 3-4-5-6-7-8 mm

Art.	□	●
2013	3/8"	1/4"













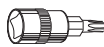

↕ 350 x 195 x 50 mm

HIGHTECH Professional socket wrench case

Estuche llaves de vaso profesional universal HIGHTECH

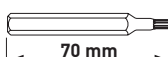
Mala HIGHTECH Profissional com roquete

		12	⊕ E4-E5-E6-E7-E8-E10-E11 E12-E14-E16-E18-E20
		12	⊕ T8-T10-T15-T20-T25-T27 T30-T40-T45-T50-T55-T60
			□ 3/8" ○ 1/4"
			□ 3/8" ○ 5/16"
		7	⊕ T10-T15-T20-T25-T27-T30-T40
		4	⊕ T45-T50-T55-T60
	 70 mm	5	● M5-M6-M8-M10-M12
			● 1/4" ■ 3/8"

Art.	□	●
4013	3/8"	1/4" + 5/16"



HIGHTECH

























↕ 260 x 160 x 60 mm

Socket wrench set

Juego de llaves de vaso

Jogo de chaves de caixa

- | | | | |
|--|---|-----------|--|
|  |  | 14 | 3.5-4-4.5-5-5.5-6-7-8
9-10-11-12-13-14 mm |
| |  | | ○ 1/4" ○ 1/4" |
| |  | | ○ 1/4" ■ 1/4" |
| |  | 2 | 50 mm / 100 mm |
| |  | | ○ 1/4" ■ 3/8" |
| |  | Art. 3200 | |
|  |  | 14 | 10-13-15-16-17-18-19
20-21-22-24 mm |
| |  | | ○ 3/8" ■ 3/8" |
| |  | 2 | 75 mm / 250 mm |
| |  | | ○ 1/2" ■ 3/8" |
| |  | Art. 3210 | |
|  |  | 4 | 4.5-5-6.5-8 mm |
| |  | 4 | PH 0-1-2-3 |
| |  | 3 | PZ 1-2-3 |
| |  | 7 | T10-T15-T20-T25-T27-T30-T40 |
| |  | 7 | T10-T15-T20-T25-T27-T30-T40 |
| |  | 6 | 3-4-5-6-7-8 mm |
| |  | | ● 1/4" ■ 1/4" |
| |  | | ● 1/4" ○ 1/4" |

Art.	○	●
3035	1/4" + 3/8"	1/4"

The most compact 1/4" + 3/8" drive set!







Socket wrench set with two 72 fine teeth slim head ratchet handles in solid ABS-case.

El juego más compacto 1/4"+3/8"!



Estuche sólido en ABS de llaves de vaso con dos carracas finas de 72 dientes.

Jogo de chaves de caixa 1/4"+3/8" mais compacto!

Com dois Roquetes de 72 dentes finos e cabeça baixa num estojo sólido em ABS.

- | | | | |
|--|---|-----------|--|
|  |  | 14 | 3.5-4-4.5-5-5.5-6-7-8-9
10-11-12-13-14 mm |
| |  | | ○ 1/4" ○ 1/4" |
| |  | | ○ 1/4" ■ 1/4" |
| |  | | 100 mm |
| |  | | ○ 3/8" ■ 1/4" |
| |  | Art. 4009 | |



- | | | | |
|--|---|----|---|
|  |  | 12 | 10-13-14-15-16-17-18-19
20-21-22-24 mm |
| |  | 2 | 16 mm / 21 mm |

Art.	○
4045	1/4" + 3/8"







ABS

380 x 212 x 55 mm



ABS

305 x 140 x 42 mm

- | | |
|--|---------------|
|  | ○ 3/8" ■ 3/8" |
|  | 150 mm |
|  | ○ 1/2" ■ 3/8" |
|  | Art. 4019 |

HIGHTECH Professional socket wrench case















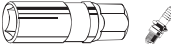

with deep impact sockets

Estuche llaves de vaso profesional universal HIGHTECH

con vasos largos de impacto

Mala HIGHTECH Professional com roquete

com chaves de impacto longas

		19		8-10-11-12-13-14-15-16-17-18 19-20-21-22-24-27-30-32-34 mm
		6		10-13-17-19-21-22 mm
		4		14-16-18-21 mm
		8		E10-E12-E14-E16-E18-E20-E22-E24
				1/2" 
				1/2" 
		2		125 mm / 250 mm
			Art. 4021	

Art.	
4027	1/2"

Socket wrench set













in solid metal case

Juego de llaves de vaso

en estuche sólido metálico

Jogo de chaves de caixa

em caixa metálica

		15		10-11-12-13-14-15-16-17-18 19-22-24-27-30-32 mm
		2		16 mm / 21 mm
				1/2" 
		2		125 mm / 250 mm
				3/8" 
			Art. 3220	

Art.	
2023	1/2"



42
PCS

HIGHTECH FINE POWER



 360 x 260 x 95 mm



22
PCS



 350 x 195 x 50 mm

TX bit-socket set

Juego de vasos con punta TX

Jogo de chaves caixa com bit TX

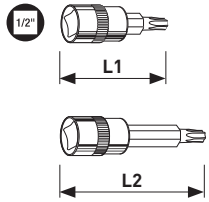

12 T10-T15-T20-T25-T27-T30
T40-T45-T50-T55-T60-T70

11 T10-T15-T20-T25-T27-T30
T40-T45-T50-T55-T60



✚ 371 x 156 x 42 mm

Art.	⊙	L1 / L2
2025	1/2"	55 / 100 mm

Hexagon- and XZN spline bit-socket set

Juego de vasos con punta hexagonal y XZN

Jogo de chaves caixa com bit sextavado e XZN

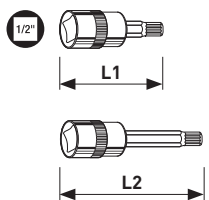

6 5-6-7-8-10-12 mm

5 M5-M6-M8-M10-M12

6 5-6-7-8-10-12 mm

5 M5-M6-M8-M10-M12



✚ 371 x 156 x 42 mm

Art.	⊙	L1 / L2
2026	1/2"	55 / 100 mm

HIGHTECH Professional socket wrench case











with deep impact sockets

Estuche llaves de vaso profesional universal HIGHTECH

con vasos largos de impacto

Mala HIGHTECH Professional com roquete

com chaves de impacto longas

-   14 ○ 3.5-4-4.5-5-5.5-6-7-8
9-10-11-12-13-14 mm
-  12 ○ 4-4.5-5-5.5-6-7-8
9-10-11-12-13 mm
-  7 ⊗ E4-E5-E6-E7-E8-E10-E11
-  3 ○ 4-5.5-6.5 mm
-  2 ⊕ PH 1-2
-  3 ⊕ PZ 0-1-2
-  8 ☆ T8-T10-T15-T20-T25-T27-T30-T40
-  6 ● 3-4-5-6-7-8 mm
-  5 ● M4-M5-M6-M7-M8

-  ○ 1/4" ○ 1/4"

-  ○ 1/4" ■ 1/4"

-  2 50 mm / 100 mm

-  150 mm

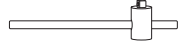
-  110 mm

-  ○ 1/4" ■ 1/4"

-  120  Art. 4001 

-   7 ☆ T10-T15-T20-T25-T27-T30-T40

-  ● 1/4" ■ 1/4"

-   16 ○ 10-13-14-15-16-17-18-19
20-21-22-24-27-30-32-34 mm

-  5 ○ 15-17-19-21-22 mm

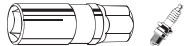
-  4 14-16-18-21 mm

-  7 ⊗ E12-E14-E16-E18-E20-E22-E24

-  4 ● M10-M12-M14-M16

-  ○ 1/2" ■ 1/2"

1/4" 1/2"

5/16" 

133
PCS

HIGHTECH FINE POWER



460 x 350 x 90 mm

-  ○ 1/2" ○ 5/16"

-  ○ 1/2" ■ 3/8"

-  2 125 mm / 250 mm

-  120  Art. 4021 

-   3 ○ 8-10-12 mm

-  2 ⊕ PH 3-4

-  2 ⊕ PZ 3-4

-  5 ☆ T45-T50-T55-T60-T70

-  3 ● 10-12-14 mm

Art.	○	●
4037	1/2" + 1/4"	5/16"

Socket wrench set

in solid metal case

Juego de llaves de vaso















en estuche sólido metálico











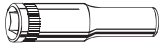
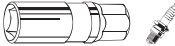

Jogo de chaves de caixa

em caixa metálica







↕ 435 x 265 x 50 mm

-   12 4-4.5-5-5.5-6-7-8-9-10-11-12-13 mm
-  3 8-10-13 mm
-   1/4"  1/4"
-   1/4"  1/4"
-  50 mm
-  115 mm
-   1/4"
-   Art. 3200

-   11 14-15-16-17-18-19-22-24-27-30-32 mm
-  2 17 mm / 19 mm
-  2 16 mm / 21 mm
-   1/2"  5/16"
-   1/2"  1/2"
-  2 125 mm / 250 mm
-   Art. 3220

-    3  4-5.5-6.5 mm
- 2  PH 1-2
- 2  PZ 1-2
- 6  T10-T15-T20-T25-T27-T30
- 4  3-4-5-6 mm

-    2  8-10 mm
- 2  PH 3-4
- 2  PZ 3-4
- 4  T40-T45-T50-T55
- 2  8-10 mm

Art.		
2033	1/4" + 1/2"	1/4" + 5/16"

Universal COMBI socket wrench case
with 2 extensible ratchet handles and combination spanners

Maleta universal de vasos COMBI
con 2 carracas extensibles y llaves combinadas

Mala de chaves de caixa universal COMBI
com 2 roquetes extensíveis e chaves combinadas



435 x 350 x 69 mm



- 13 4-4.5-5-5.5-6-7-8-9-10-11-12-13-14 mm
- 5/32"-7/32"-1/4"-5/16"-11/32"-3/8"-7/16"
15/32"-1/2"-9/16"
- TX E5-E6-E8-E10-E12-E14-E16-E18
- XZN M5-M6-M8-M10-M12-M14-M16-M18

- 1/4" 1/4"
- 1/4" 1/4"
- 2 50 mm / 100 mm
- 150 mm
- 1/4"

- Art. 2000 150-200 mm

- 12 15-16-17-18-19-20-21-22-24-27-30-32 mm
- 19/32"-5/8"-11/16"-3/4"-25/32"-13/16"-7/8"
15/16"-1-1/16"-1-3/16"-1-1/4"
- TX E20-E22-E24-E26-E28-E30-E34-E38-E40

- 2 16 mm / 21 mm
- 1/2" 1/2"
- 2 125 mm / 250 mm
- 1/2" 3/8"

- Art. 2020 305-445 mm

- 4 4.5-5-6.5-8 mm
- 4 PH 0-1-2-3
- 3 PZ 1-2-3
- 7 T10-T15-T20-T25-T27-T30-T40
- 7 T10-T15-T20-T25-T27-T30-T40
- 6 3-4-5-6-7-8 mm

- 1/4" 1/4"
- 1/4" 1/4"
- 9 8-10-11-12-13-14-17-19-22 mm

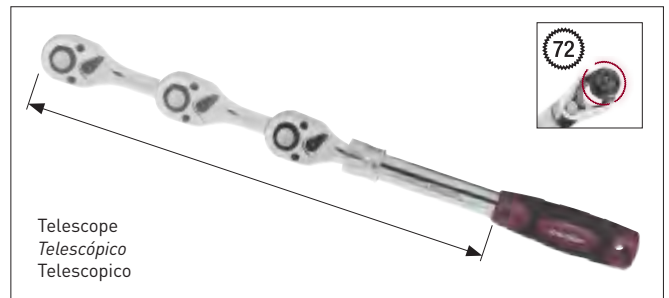

Art.	<input type="checkbox"/>	<input type="checkbox"/>
2034	1/4" + 1/2"	1/4"

Socket wrench set

in solid metal case with hard plastic edge protection

























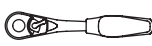

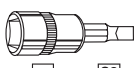
Juego de llaves de vaso

en estuche metálico con bordes de protección en plástico

Conjunto de chaves

em caixa metálica com cantos protectores em plástico endurecido



-   13 3.5-4-4.5-5-5.5-6-7-8-9
10-11-12-13 mm
-   1/4"  1/4"
-   1/4"  1/4"
-   1/4"  1/4"
-  2 50 mm / 100 mm
-   1/4"
-   Art. 3200 
-  3  4-5-5.5 mm
-  3  PH 1-2-3
-  3  PZ 1-2-3
-  8  T8-T10-T15-T20-T25-T27-T30-T40
-  5  3-4-5-6-8 mm

-   7  T10-T15-T20-T25-T27-T30-T40

-   12 14-15-16-17-18-19-21
22-24-27-30-32 mm

-   2 16 mm / 21 mm

-   1/2"  1/2"

-   3/8"  1/2"

-  2 125 mm / 250 mm



-   Art. 3220 

-  4  1.27-1.5-2-2.5 mm



450 x 190 x 57 mm



Art.		
2032	1/4" + 1/2"	1/4"





**Heavy duty
socket wrench cases**

Fine teeth ratchet handles with socket quick release function and extension bars with locking system

**Estuches industriales
de llaves de vaso**

Carracas con función de extracción rápida y alargadera con sistema de bloqueo

**Jogos de chaves de caixa
"Heavy duty"**

Roquetes com mecanismo de ejeção de chaves e extensões com sistema de segurança

Socket wrench case

with ratchet handle without telescope function



Estuche de llaves de vaso

con carraca sin función de mango telescópico/extensible

Jogo de chaves de caixa

com roquete sem mecanismo extensível

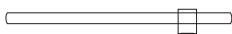
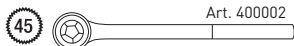

		16	19-21-22-23-24-26-27-29 30-32-35-36-38-41-46-50 mm
		3	100-200-400 mm
			460 mm
			500 mm



535 x 383 x 100 mm

Art.	□
2056	3/4"

Socket wrench case

with extensible/telescope ratchet handle

Estuche de llaves de vaso

Carraca con mango telescópico/extensible

Jogo de chaves de caixa

com roquete extensível

  16 19-21-22-23-24-26-27-29
30-32-35-36-38-41-46-50 mm

 3 100-200-400 mm

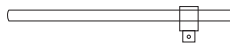
 460 mm

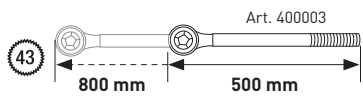
 Art. 400003
800 mm 500 mm



Art.	○
2057	3/4"



 535 x 383 x 100 mm

Socket wrench case



with extensible/telescope ratchet handle, in solid metal case

Estuche de llaves de vaso

Carraca con mango telescópico/extensible, en caja metálica maciza

Jogo de chaves de caixa

com roquete extensível, em caixa metálica

  17 36-38-41-46-50-54-55-58-60
63-65-67-70-71-75-77-80 mm

 2 200 mm / 400 mm

 ○ 1" ■ 1"

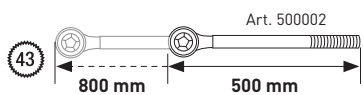
 Art. 500002
800 mm 500 mm

Art.	○
2053	1"



 700 x 280 x 108 mm

Pass-through socket wrench sets

1. The pass-through head design enables the fastening and unfastening jobs with long bolt and threaded rods. No deep sockets needed anymore.
2. The unique drive configuration increases torque strength by 40%. The 72 teeth ratchet handle reduces the return angle to 5° only.
3. Overall height is reduced by 50%, width by 20%.
4. Usage of standard sockets with quick release adapters 1/4", 3/8" and 1/2" drive.



Juegos de llaves de vaso abiertas

1. La cabeza abierta de la carraca permite la entrada en un espárrago largo para el apriete/desapriete de tuercas. ¡Se acabaron los vasos largos!
2. La configuración especial de la carraca incrementa la fuerza de apriete en un 40%. Carraca con 72 dientes que reduce el ángulo de recuperación a sólo 5°.
3. Reducción de la altura en un 50% y del grosor en un 20%.
4. Utilización de vasos standard con adaptadores de extracción rápida de 1/4", 3/8" y 1/2".

Jogos de chaves de caixa de aperto

1. O desenho da cabeça do roquete permite o aperto e o desaperto de parafusos longos e varão roscado. A utilização de chaves longas não será mais necessária.
2. A configuração única e especial deste roquete aumenta a força do torque em 40%. O roquete de 72 dentes finos diminui o ângulo de aperto a apenas 5°.
3. Redução da altura em 50% e da espessura em 20%.
4. Utilização de chaves standard com adaptadores 1/4", 3/8" e 1/2".

Pass-through socket wrench set Juego de llaves de vaso abiertas Jogo de chaves de caixa de aperto

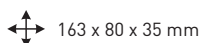
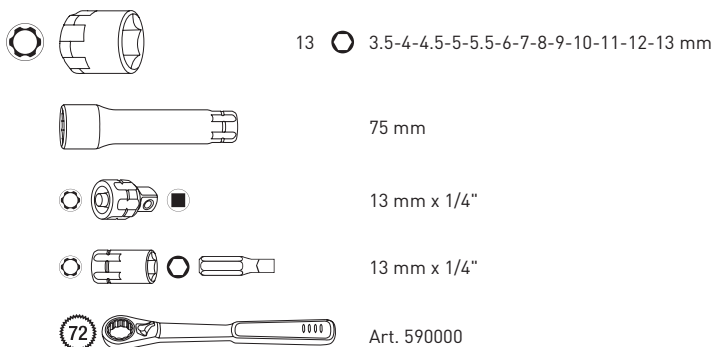

Art.	
4002	13 mm

Pass-through socket wrench set
Juego de llaves de vaso abiertas
Jogo de chaves de caixa de aperto

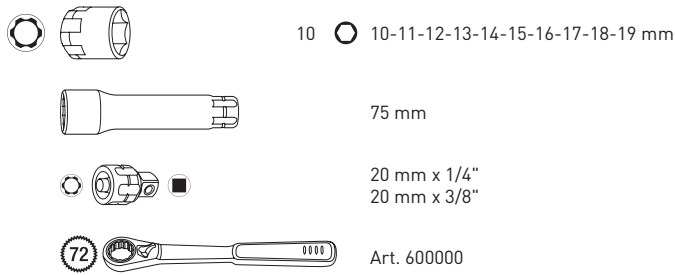

Art.	
4012	20 mm



305 x 140 x 42 mm

Pass-through socket wrench set
Juego de llaves de vaso abiertas
Jogo de chaves de caixa de aperto

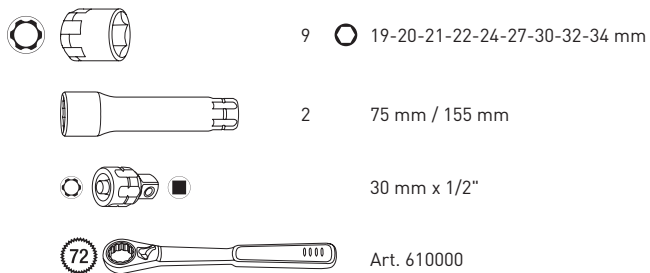

Art.	
4022	30 mm



380 x 210 x 55 mm

Impact socket wrench set

Juego de llaves de vaso de impacto

Jogo de chaves impacto

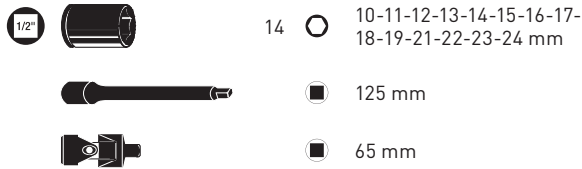

Art.
380005

Deep impact socket wrench set

with plastic insert to protect the wheel nuts and plastic sleeve for aluminium rims

Juego de llaves de vaso largo de impacto

con plástico para proteger las tuercas de rueda y recubrimiento plástico para llantas de aluminio

Jogo de chaves impacto

com protecção plástica para proteger as porcas das rodas e manga plástica para as jantes de alumínio

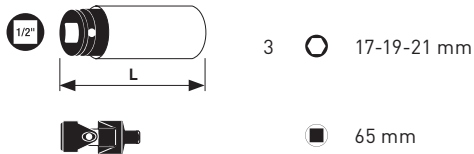

Art.	L mm
3083	85

Deep impact socket wrench set

with plastic insert to protect the wheel nuts and plastic sleeve for aluminium rims

Juego de llaves de vaso largo de impacto

con plástico para proteger las tuercas de rueda y manga plástica para llantas de aluminio

Jogo de chaves impacto

com protecção plástica para proteger as porcas das rodas e manga plástica para as jantes de alumínio

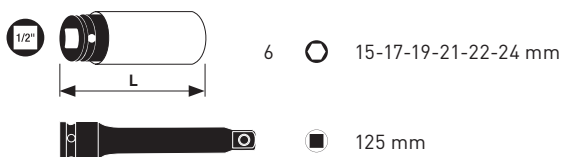

Art.	L mm
381005	85

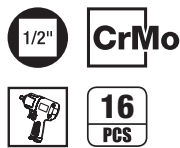

270 x 185 x 58 mm



AUTOMOTIVE



145 x 130 x 43 mm



AUTOMOTIVE



212 x 151 x 48 mm

TX impact socket wrench set

Juego de llaves de vaso de impacto, TX

Jogo de chaves de caixa impacto TX



12 T10-T15-T20-T25-T27-T30
T40-T45-T50-T55-T60-T70

Art.	L mm
3084	78



210 x 145 x 50 mm

Hexagonal impact socket wrench set

Juego de llaves de vaso de impacto, hexagonal

Jogo de chaves de caixa impacto sextavada



12 3-4-5-6-7-8-9-10
12-14-16-17 mm

Art.	L mm
3086	78



210 x 145 x 50 mm

XZN impact socket wrench set

Juego de llaves de vaso de impacto, XZN

Jogo de chaves de caixa impacto XZN



210 x 145 x 50 mm

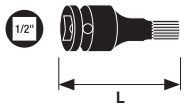

10 M4-M5-M6-M8-M9-M10
M12-M14-M16-M18

Art.	L mm
3087	78

RIBE impact socket wrench set

Juego de llaves de vaso de impacto, RIBE

Jogo de chaves de caixa impacto RIBE



210 x 145 x 50 mm

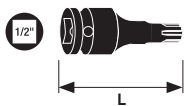

10 RM4-RM5-RM6-RM7-RM8-RM9
RM10-RM12-RM13-RM14



Art.	L mm
3089	78

Impact socket wrench set
Juego de llaves de vaso largo de impacto
Jogo de chaves impacto

  8  26-27-29-30-32-35-36-38 mm

Art.

400005

 **CrMo**
 **8**
PCS





 465 x 186 x 78 mm

Deep impact socket wrench set
Juego de llaves de vaso largo de impacto
Jogo de chaves longa impacto

  8  26-27-29-30-32-35-36-38 mm

Art.

400015

 **CrMo**
 **8**
PCS





 465 x 186 x 78 mm

Deep impact socket wrench set
Juego de llaves de vaso largo de impacto
Jogo de chaves longa impacto

  7  24-27-30-32-33-36-38 mm

Art.

500015

 **CrMo**
 **7**
PCS



 465 x 186 x 78 mm

HIGHTECH Professional socket wrench case

metric and inch, with 4 ratchet handles, impact sockets, combination spanners and bits for safety screws.

Estuche llaves de vaso profesional universal HIGHTECH

métrico y pulgadas, con 4 carracas, llaves combinadas y puntas, incluso puntas para tornillos de seguridad.

Mala HIGHTECH Professional com roquete

chaves e bits combinados, compatível mesmo para parafusos de segurança. Sistema métrico e polegada.



HIGHTECH FINE POWER



550 x 380 x 110 mm

- 14 3.5-4-4.5-5-5.5-6-7-8-9
10-11-12-13-14 mm
- 5 1/4"-9/32"-5/16"-11/32"-3/8"
- 8 4-4.5-5-5.5-6-7-8-9 mm
- 5 E4-E5-E6-E7-E8
- 5 M4-M5-M6-M7-M8
- 1/4" 1/4"
- 1/4" 1/4"
- 2 50 mm / 100 mm
- 150 mm
- 110 mm
- 1/4" 1/4"
- Art. 4001 HIGHTECH FINE POWER

- 10 10-11-12-13-14
15-16-17-18-19 mm
- 10 7/16"-1/2"-9/16"-5/8"-11/16"
3/4"-13/16"-7/8"-15/16"-1"
- 6 10-11-12-13-14-15 mm
- 4 14-16-18-21 mm
- 4 E10-E11-E12-E14
- 3/8" 1/4"
- 3/8" 5/16"
- 3/8" 3/8"
- 3/8" 1/4"
- 3/8" 1/2"
- 2 75 mm / 250 mm
- Art. 4011 HIGHTECH FINE POWER

- 6 4-4.5-5.5-6-6.5-8 mm
- 4 PH 1-2-3-4
- 4 PZ 1-2-3-4
- 8 T8-T10-T15-T20-T25-T27-T30-T40
- 8 T8-T10-T15-T20-T25-T27-T30-T40
- 6 3-4-5-6-7-8 mm
- 6 2-2.5-3-4-5-6 mm
- 6 5/64"-3/32"-7/64"-1/8"-9/64"-5/32"
- 3 Nos. 6-8-10
- 4 Nos. 1-2-3-4
- 4 Nos. 4-6-8-10



Art.			
4047	1/4" + 3/8" + 1/2"		1/4" + 5/16"















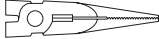



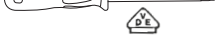

- 15 10-13-15-16-17-18-19-20
21-22-24-27-30-32-34 mm
- 4 17-19-21-22 mm
- 5 E16-E18-E20-E22-E24
- 4 M10-M12-M14-M16
- 1/2" 5/16"
- 1/2" 1/2"
- 1/2" 3/8"
- 2 125 mm / 250 mm
- Art. 4021 HIGHTECH FINE POWER
- Art. 3006 HIGHTECH FINE POWER
- 1/4" 1/4"
- 2 10-12 mm
- 5 T45-T50-T55-T60-T70
- 3 10-12-14 mm
- 8 T20-T25-T27-T30-T40-T45-T50-T55
- 1/4" 1/4"
- 1/4" 1/4"
- 1/4" 3/8"
- 1/4" x 100 mm
- 8-9-10-11-12-13-14-15
16-17-18-19-22 mm
- 13 1.5-2-2.5-3-4-5-6-7-8-10 mm
- 10 1.5-2-2.5-3-4-5-6-7-8-10 mm
- 200 mm (0-36 mm)
- M22

Electrician tool-set
Surtido de herramientas para electricista
Jogo de ferramentas de electricista

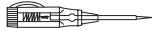
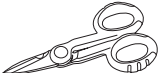
20
PCS

1000 V



-   180 mm
-   160 mm
-   200 mm
-   160 mm
-   4 0.4 x 2.5 mm - 0.8 x 4.0 mm
1.0 x 5.5 mm - 1.2 x 6.5 mm
-   2 PH 1-2
-   2 T15-T20
-  110-250V
-  140 mm
-  160 mm
-  150 mm
-  140 mm
-  228 mm
-  175 mm



↕ 220 x 300 x 100 mm

Art.	
3996ET	
2990B	without tools / <i>sin herramientas</i> / <i>sem ferramentas</i>



Art. 2990B

Professional ABS tool case

with solid structure, aluminium frame and reinforced edges for shock-protection, snap locks and combination lock.

Maleta profesional en ABS

con estructura sólida, reforzada en aluminio, con protección contra golpes y cerradura con código numérico.

Mala profissional em ABS

com estrutura solida com chassis em aluminio e protecção antichoque, com fechaduras numericas.



489 x 193 x 400 mm

1/4" 14 3.5-4-4.5-5-5.5-6-7-8-9
10-11-12-13-14 mm



1/4" 1/4"



1/4" 1/4"



100 mm



Art. 3200B

3/8" 12 10-13-14-15-16-17-18
19-20-21-22-24 mm



2 16 mm / 21 mm



3/8" 1/4"



3/8" 3/8"



1/2" 3/8"



150 mm



Art. 3210B

1/4" 4 4.5-5.5-6.5-8 mm



4 PH 0-1-2-3



3 PZ 1-2-3



7 T10-T15-T20-T25-T27-T30-T40



7 T10-T15-T20-T25-T27-T30-T40



6 3-4-5-6-7-8 mm



1/4" 1/4"



1/4" 1/4"



Art. 2336 360 g



Art. 2303 300 g



10 1.5-2-2.5-3-4-5
6-7-8-10 mm

Art. 3602



9 T10-T15-T20-T25-T27
T30-T40-T45-T50

Art. 3605

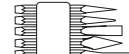

5 Art. 3370

4 x 150 mm
12 x 130 mm
5 x 130 mm
3 x 120 mm
4 x 120 mm









6 Art. 4321



165 mm



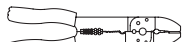

Art.	1/4"	3/8"	1/4"	4 mm
3995	1/4" + 3/8"		1/4" + 4 mm	
3995.1	Version with PB screwdrivers Modelo con destornilladores PB Modelo com chaves parafusos PB			





	Art. 3281-180	180 mm
	Art. 3285-200	200 mm
	Art. 3282-160	160 mm
	Art. 2221-250	250 mm
	Art. 3289-160	160 mm
	Art. 2240	150 mm
	Art. 2225	240 mm



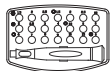

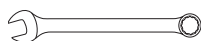
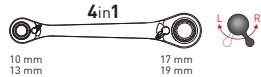

	6	Art. 3312	18 mm
	10x	Art. 3314	18 mm

	5	<ul style="list-style-type: none"> Art. 4110-1 0.5 x 3 mm Art. 4110-2 0.8 x 4 mm Art. 4110-3 0.9 x 5 mm Art. 4110-4 1.1 x 6 mm Art. 4110-5 1.2 x 8 mm
	2	<ul style="list-style-type: none"> Art. 4115-1 No. 1 Art. 4115-2 No. 2
	4	<ul style="list-style-type: none"> Art. 4125-15 T15 Art. 4125-20 T20 Art. 4125-25 T25 Art. 4125-30 T30
	1	Art. 4128 1/4" x 100mm
		Art. 4701-0519 5 m x 19 mm
		Art. 3180

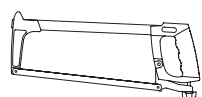
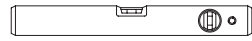

	16	5.5-6-7-8-9-10-11-12-13 14-15-16-17-18-19-22 mm
 <p>4in1 10 mm 13 mm 17 mm 19 mm</p>		Art. 3404-1019 10 x 13 mm / 17 x 19 mm
		Art. 2138 110-250 V

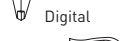
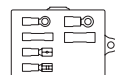

	Art. 3305	300 mm
		400 mm
 <p>320 mm / No. 2</p>	Art. 4320-2	320 mm
	Art. 3574	250 mm / 10"
	Art. 2972C	150 mm / 0 - 6"
	Art. 32065	6 LED [excl. 3x AAA]
	50	



Universal socket wrench- and tool-set
in slim, lockable aluminium tool-case

Surtido universal de llaves de vaso y herramientas

en maleta compacta de aluminio y cerradura con llave





















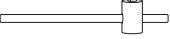

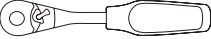















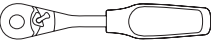











Conjunto universal de chaves caixa e ferramentas

em mala de aluminio compacta e bloqueável

1/4" 1/2" 1/4" 109 PCS

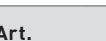

470 x 330 x 90 mm

- 
 14 3.5-4-4.5-5-5.5-6-7
8-9-10-11-12-13-14 mm
-  5 8-10-11-12-13 mm
-   1/4"  1/4"
-   1/4"  1/4"
-  2 50 mm / 100 mm
-  115 mm
-   Art. 3200B
-   1/4"
- 
 15 10-13-14-15-16-17-18-19
21-22-24-27-30-32-34 mm
-  4 14-17-18-19 mm
-  **CrMo** 3 17-19-21 mm 
-  2 16 / 21 mm
-   1/2"  1/2"
-  2 125 / 250 mm
-   3/8"  1/2"
-   Art. 3220B
- 
  6  4-4.5-5.5-6-6.5-8 mm
-  4  PH 0-1-2-3
-  3  PZ 1-2-3
-  6  T10-T15-T20-T25-T30-T40
-  6  T10-T15-T20-T25-T30-T40
-  6  3-4-5-6-7-8 mm
-   1/4"  1/4"
-   1/4"  1/4"
-  9  1.5-2-2.5-3-4-5-6-8-10 mm
-  12 8-10-11-12-13-14-15
16-17-18-19-22 mm

Art.		
4055	1/4" + 1/2"	1/4"

































































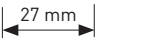





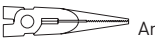

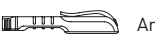

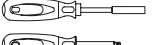

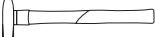





Professional tool case

Maletín con herramientas profesionales



Mala de ferramentas profissional

1/4" 1/4" 4 mm CrV

123
PCS

- 1/4"  14  3.5-4-4.5-5-5.5-6-7-8
9-10-11-12-13-14 mm
-   2  1/4"  1/4"
-   2  50 mm / 100 mm
110 mm
-  45   Art. 3200B
-  3  1.5-2-2.5 mm
 1/4"  1/4"
-   3 m x 16 mm
-  8 8-10-11-12-13-14-17-19 mm
- 1/4"  4 4.5-5-6.5-8 mm
-  4  PH 0-1-2-3
-  3  PZ 1-2-3
-  7  T10-T15-T20-T25-T27-T30-T40
-  7  T10-T15-T20-T25-T27-T30-T40
-  6  3-4-5-6-7-8 mm
 1/4"  1/4"
-  4 mm  5 1.5-2-2.5-3-4 mm
-  3  PH000-00-0
-  2  PZ 00-0
-  4  T4-T5-T6-T7
-  4  T8-T9-T10-T15
-  3  1.5-2-2.5 mm
-  1  4.0 x 95 mm
-  9  1.5-2-2.5-3-4-5-6-8-10 mm \leftrightarrow 397 x 270 x 134 mm
-  2 50 mm / 100 mm
110 mm
-  4 4.5-5-6.5-8 mm
-  4 PH 0-1-2-3
-  3 PZ 1-2-3
-  7 T10-T15-T20-T25-T27-T30-T40
-  7 T10-T15-T20-T25-T27-T30-T40
-  6 3-4-5-6-7-8 mm
1/4" 1/4"
-  4 mm 5 1.5-2-2.5-3-4 mm
-  3 PH000-00-0
-  2 PZ 00-0
-  4 T4-T5-T6-T7
-  4 T8-T9-T10-T15
-  3 1.5-2-2.5 mm
-  1 4.0 x 95 mm
-  9 1.5-2-2.5-3-4-5-6-8-10 mm \leftrightarrow 397 x 270 x 134 mm
-  Art. 1789
-  Art. 3180
-  Art. 3601
-  Art. 3281-180 180 mm
-  Art. 3282-160 160 mm
-  Art. 3285-200 200 mm
-  Art. 2221-250 250 mm
-  Art. 3310 3 9 mm
-  Art. 3313 10 9 mm
-  Art. 32065 6 LED (excl. 3x AAA)
-  Art. 4110-2 2  4.0 x 100 mm
Art. 4110-4 2  6.0 x 150 mm
-  Art. 4115-1 2  PH 1 x 75 mm
Art. 4115-2 2  PH 2 x 100 mm
-  Art. 4128  1/4" x 100 mm
-  Art. 2850  1/4"
-  Art. 2138 110-250V
- Art. 2303 300 g



Art.		
3944	1/4"	1/4" + 4 mm
3944.1	Version with PB screwdrivers Modelo con destornilladores PB Modelo com chaves parafusos PB	
3944.2	Version with PB screwdrivers and Hightech pliers Modelo con destornilladores PB y pinzas Hightech Modelo com chaves parafusos PB e alicates Hightech	



Professional aluminium tool-case
Maletín profesional en aluminio
Mala de ferramentas em alumínio

1/4" 3/8" 1/4" 4 mm

CrV **151**
PCS



433 x 323 x 149 mm

- 1/4" 7 3.5-4-4.5-5-5.5-6-7 mm
- 3/8" 16 8-9-10-11-12-13-14-15-16
17-18-19-20-21-22-24 mm
- 2 16 mm / 21 mm
- 3/8" 1/4"
- 3/8" 3/8"
- 2 75 mm / 150 mm
- 3/8" 1/2"
- 3/8" 1/4"
- 45 Art. 3210B
- 1/4" 4 4.5-5-6.5-8 mm
- 25 mm 4 PH 0-1-2-3
- 3 PZ 1-2-3
- 7 T10-T15-T20-T25-T27-T30-T40
- 7 T10-T15-T20-T25-T27-T30-T40
- 6 3-4-5-6-7-8 mm
- 1/4" 1/4"
- 1/4" 1/4"
- 4 mm 5 1.5-2-2.5-3-4 mm
- 27 mm 3 PH00-00-0
- 2 PZ 00-0
- 4 T4-T5-T6-T7
- 4 T8-T9-T10-T15
- 3 1.5-2-2.5 mm
- 1 4.0 x 95 mm
- Art. 2410 250 mm / 10"
- 3 1.5-2-2.5 mm
- 10 1.5-2-2.5-3-4
- 5-6-7-8-10 mm
- Art. 3281-180 180 mm
- Art. 3282-160 160 mm
- Art. 3285-200 200 mm
- Art. 2221-250 250 mm
- Art. 2240 150 mm
- Art. 2303 300 g
- 4 x 150 mm
- 12 x 130 mm
- 5 x 130 mm
- 3 x 120 mm
- 4 x 120 mm
- Art. 3370 5 300 mm
- Art. 3305 300 mm

- 3 300 mm / 24t
- Art. 3312 6 18 mm
- Art. 3314 10 18 mm
- Art. 4320-2
- 250 mm / No. 2
- 175 mm
- 150 mm / 0-6" digital
- 3 m x 16 mm
- 6 LED (excl. 3x AAA)
- 4.0 x 100 mm
- 6.0 x 150 mm
- 2 PH 1 x 75 mm
- 2 PH 2 x 100 mm
- 1/4" x 100 mm
- Art. 2138 110-250V



Art.				
3946	1/4" + 3/8"		1/4" + 4 mm	
3946.1	Version with PB screwdrivers Modelo con destornilladores PB Modelo com chaves parafusos PB			
3946.2	Version with PB screwdrivers and Hightech pliers Modelo con destornilladores PB y pinzas Hightech Modelo com chaves parafusos PB e alicates Hightech			



Professional aluminium tool-case
Maletín profesional en aluminio
Mala de ferramentas em alumínio



- 14 3.5-4-4.5-5-5.5-6-7
8-9-10-11-12-13-14 mm
- 1/4" 1/4"
- 1/4" 1/4"
- 2 50 mm / 100 mm
- 1/4" 1/4"
- 45 Art. 3200B
- 14 10-13-15-16-17-18-19
20-21-22-24-27-30-32 mm
- 1/2" 1/2"
- 250 mm
- 3/8" 1/2"
- 45 Art. 3220B
- 1/4" 4 4.5-5-6.5-8 mm
- 25 mm
- 4 PH 0-1-2-3
- 3 PZ 1-2-3
- 7 T10-T15-T20-T25-T27-T30-T40
- 7 T10-T15-T20-T25-T27-T30-T40
- 6 3-4-5-6-7-8 mm
- 1/4" 1/4"
- 1/4" 1/4"
- 1/4" 1/4"
- 9 8-10-11-12-13-14-17-19-22 mm
- Art. 2410 250 mm / 10"
- Art. 3602 10 1.5-2-2.5-3-4-5-6-7-8-10 mm
- Art. 3605 9 T10-T15-T20-T25-T27
T30-T40-T45-T50
- Art. 4110-2 0.8 x 4.0 mm
- Art. 4110-3 0.9 x 5.0 mm
- Art. 4110-4 1.1 x 6.0 mm
- Art. 4115-1 2 PH 1-2
- Art. 4115-2
- Art. 4125-15 4 T15-T20-T25-T30
- Art. 4125-20
- Art. 4125-25
- Art. 4125-30
- Art. 4128 1/4"
- Art. 2138 110-250V
- Art. 3281-180 180 mm
- Art. 3282-160 160 mm Art. 3180



489 x 365 x 178 mm

- Art. 3285-200 200 mm
- Art. 2221-250 250 mm
- Art. 2216-200 200 mm
- Art. 2225 240 mm
- Art. 2240 150 mm
- Art. 2303 300 g
- Art. 3370 5
- 4 x 150 mm
- 12 x 130 mm
- 5 x 130 mm
- 3 x 120 mm
- 4 x 120 mm
- Art. 3305 300 mm
- 3 300 mm / 24Z
- Art. 3310 9 mm
- Art. 3313 10 9 mm
- Art. 3312 18 mm
- Art. 3314 10 18 mm
- Art. 4320-2 320 mm / No. 2
- 6 160 mm
- Art. 3197 2000 g
- 175 mm
- Art. 32065 6 LED (excl. 3x AAA)
- 150 mm
- 0-6" / digital
- 5 m x 19 mm
- 20 200 mm



Art.		
3948	1/4" + 1/2"	1/4" + 4 mm
3948.1	Version with PB screwdrivers Modelo con destornilladores PB Modelo com chaves parafusos PB	
3948.2	Version with PB screwdrivers and Hightech pliers Modelo con destornilladores PB y pinzas Hightech Modelo com chaves parafusos PB e alicates Hightech	



Professional tool case with BOSCH cordless drill/driver

with edge protection. The tools are shakeproof embedded in special high density soft foam (EVA) inserts with a durable hard top lamination resp. well fixed in pouches or rubber bands on the tool-pallets and in the case cover.

Maletín con herramientas profesionales con atornillador / taladro a batería BOSCH

con protección de bordes. Las herramientas están encastradas en bandejas de espuma de alta densidad (EVA), con recubrimiento plástico superior resistente, bien fijadas en las bandejas con bandas elásticas.

Mala de ferramentas profissional com aparafusadora a bateria BOSCH

com cantos protegidos. As ferramentas estão inseridas em espuma de alta densidade (EVA) com uma protecção acrílica. Bem fixas em bolsas nos tabuleiros ou bandas elásticas na tampa da mala.



489 x 365 x 178 mm



- 1/4" 14 3.5-4-4.5-5-5.5-6-7-8-9 10-11-12-13-14 mm
- 1/4" 1/4" 1/4"
- 1/4" 1/4" 1/4"
- 100 mm
- 45 45
- 1/4" 1/4" 1/4"
- 1/2" 12 15-16-17-18-19-20 21-22-24-27-30-32 mm
- 1/2" 1/2" 1/2"
- 3/8" 1/2"
- 250 mm

- 45 45
- 1/4" 1/4" 1/4"
- 19 19
- 2x 2x
- Li-Ion 10.8 V 2000 mAh
- 60-min 60-min











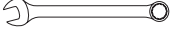

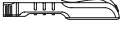

Art. 3220B

- 4 4.5-5.5-6.5-8 mm
- 4 PH 0-1-2-3
- 3 PZ 1-2-3
- 7 T10-T15-T20-T25-T27-T30-T40
- 7 T10-T15-T20-T25-T27-T30-T40
- 6 3-4-5-6-7-8 mm
- 1/4" 1/4"
- 1/4" 1/4"
- 19 Ø 1-10 mm / 0.5 mm HSS-G / DIN 338 N

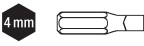







BOSCH
GSR 10,8-2-LI Professional

Art.	1/4" + 1/2"	1/4" + 4 mm
3949		
3949.1	Version with PB screwdrivers Modelo con destornilladores PB Modelo com chaves parafusos PB	
3949.2	Version with PB screwdrivers and Hightech pliers Modelo con destornilladores PB y pinzas Hightech Modelo com chaves parafusos PB e alicates Hightech	



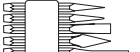







	8	8-10-11-12-13-14-17-19 mm
	Art. 3602 10	1.5-2-2.5-3-4-5-6-7-8-10 mm
	Art. 3605 9	T10-T15-T20-T25-T27 T30-T40-T45-T50
	Art. 4320-2	320 mm / No. 2
	6	165 mm
	Art. 2138	110-250V
	Art. 3196	2000 g
	Art. 32065	6 LED (excl. 3x AAA)
	Art. 4701-0519	5 m x 19 mm
	5	1.5-2-2.5-3-4 mm
	3	PH000-00-0
	2	PZ 00-0
	4	T4-T5-T6-T7
Art. 3180	4	T8-T9-T10-T15
	3	1.5-2-2.5 mm
	1	4.0 x 95 mm

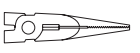
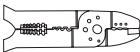

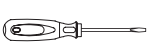
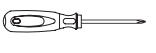
	Art. 2410	250 mm / 10"
	Art. 3305	300 mm
	Art. 3316-24 3	300 mm / 24Z
	Art. 3970	228 mm
	Art. 2303	300 g
	Art. 3370 5	4 x 150 mm 12 x 130 mm 5 x 130 mm 3 x 120 mm 4 x 120 mm
	Art. 3312	18 mm
	Art. 3314 10	18 mm
	20	

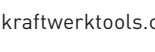

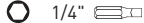
	Art. 2240	150 mm
	Art. 3281-180	180 mm
	Art. 3282-160	160 mm
	Art. 3285-200	200 mm
	Art. 2225	240 mm
	50	
	Art. 2221-250	250 mm
	Art. 4110-2	0.8 x 4.0 mm
	Art. 4110-3	0.9 x 5.0 mm
	Art. 4110-4	1.1 x 6.0 mm
	Art. 4115-1	2
	Art. 4115-2	PH 1-2
	Art. 4128	1/4" 



HIGHTECH FINE POWER

120 fine-tooth ratchet handle in compact and slim carbon look PU-case with anodized aluminium frame and snap locks.

Maletín ABS HIGHTECH FINE POWER

con carraca de precisión de 120 dientes, en maletín de PU con efecto carbono y estructura en aluminio anodizado y cerradura.

Mala em ABS HIGHTECH FINE POWER









com roquete de 120 dentes finos, inseridos numa mala de PU estilo carbono com moldura de alumínio anodizado e fecho.



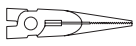

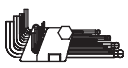
HIGHTECH FINE POWER

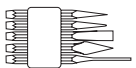
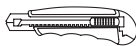

485 x 350 x 120 mm

-  Art. 3282-160 160 mm
-  Art. 3281-180 180 mm
-  Art. 3285-200 200 mm
-  Art. 2221-250 250 mm
-  Art. 3602 10  1.5-2-2.5-3-4-5-6-7-8-10 mm
-  Art. 3370 5
4 x 150 mm
12 x 130 mm
5 x 130 mm
3 x 120 mm
4 x 120 mm
-  Art. 3312 18 mm
-  Art. 3314 10 18 mm



Art.		
4015	1/4" + 3/8"	1/4" + 4 mm
4015.1	Version with PB screwdrivers Modelo con destornilladores PB Modelo com chaves parafusos PB	



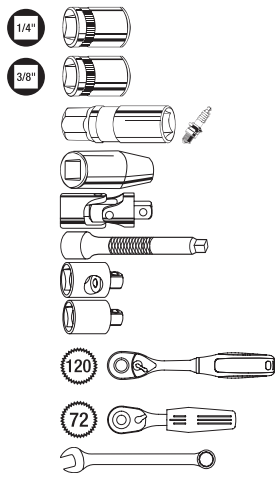

- 7 ○ 3.5-4-4.5-5-5.5-6-7 mm
- 16 ○ 8-9-10-11-12-13-14-15-16
17-18-19-20-21-22-24 mm
- 2 ○ 16 mm / 21 mm
- 3/8" ○ 1/4"
- 3/8" ■ 3/8"
- 2 75 mm / 150 mm
- 1/2" ■ 3/8"
- 3/8" ■ 1/4"



Art. 3210
HIGHTECH FINE POWER
Art. 3799

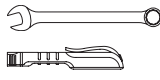

- 8 8-10-11-12-13-14-17-19 mm
- Art. 32065 6 LED (excl. 3x AAA)

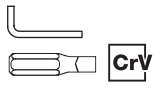

- 3 ● 1.5-2-2.5 mm
- 5 — 1.5-2-2.5-3-4 mm
- 3 + PH000-00-0
- 2 + PZ 00-0
- 4 * T4-T5-T6-T7
- 4 * T8-T9-T10-T15
- 3 ● 1.5-2-2.5 mm
- 4.0 x 95 mm

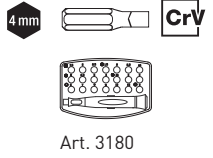

Art. 3180

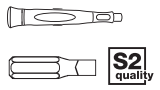

- 6 — 4-4.5-5.5-6-6.5-8 mm
- 4 + PH 1-2-3-4
- 4 + PZ 1-2-3-4
- 8 * T8-T10-T15-T20-T25-T27-T30-T40
- 8 * T8-T10-T15-T20-T25-T27-T30-T40
- 6 ● 3-4-5-6-7-8 mm
- 6 ● 2-2.5-3-4-5-6 mm
- 6 ● 5/64"-3/32"-7/64"-1/8"-9/64"-5/32"
- 4 ● Nos. 4-6-8-10
- 4 ▲ Nos. 1-2-3-4
- 3 + Nos. 6-8-10

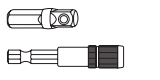
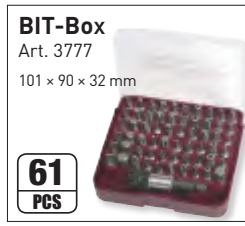

- 1/4" ■ 1/4"
- 1/4" ○ 1/4"

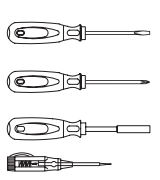

- Art. 4110-2 2 — 4.0 x 100 mm
- Art. 4110-4 2 — 6.0 x 150 mm
- Art. 4115-1 2 + PH1 x 75 mm
- Art. 4115-2 2 + PH2 x 100 mm
- Art. 4128 ○ 1/4" x 100
- Art. 2138 110-250V

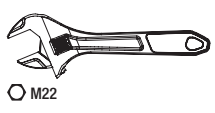

- Art. 47123 200 mm (0-36 mm)
- M22



- Art. 2303 300 g

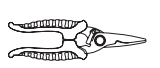

- Art. 2240 150 mm

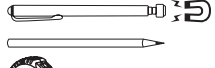

- Art. 3196 130 - 630 mm 2 kg



- 175 mm
- Art. 4701-0316 3 m x 16 mm



Universal tool set

in solid metal tool box with 5 compartments, lockable with padlock. With the tidy PS-tray system, the position of each tool is quickly found. Tool-contents specially matching the requests of the apprentices. Box dimensions fitting the lockers!

Juego de herramientas universales

en caja sólida de 5 compartimentos, cerradura con candado. Con sistema de bandejas en PVC, cada herramienta se localiza fácilmente. Herramientas especialmente seleccionadas para aprendices. Las dimensiones de la caja se adaptan a los armarios. Bandeja vacía para uso individual.

Conjunto de ferramentas universais

em caixa sólida de 5 compartimentos, fechadura com cadeado. Com sistema de bandejas em PVC, a posição de cada ferramenta encontra-se facilmente. Ferramentas especialmente seleccionadas para aprendizes. As dimensões da caixa adaptam-se aos armários.



1/4" 1/2" 1/4" 106 PCS

485 x 260 x 240 mm

		11	3.5-4-5-6-7-8-9 10-11-12-13 mm
			50 mm
			1/4" 1/4"
			Art. 3200B
		14	10-13-14-15-16-17-18 19-21-22-24-27-30-32 mm
			125 mm
			1/2" 1/2"
			Art. 3220B
		4	4.5-5.5-6.5-8 mm
		4	PH 0-1-2-3
		3	PZ 1-2-3
		7	T10-T15-T20-T25-T27-T30-T40
		7	T10-T15-T20-T25-T27-T30-T40
		6	3-4-5-6-7-8 mm
			1/4" 1/4"
			1/4" 1/4"
		10	8-9-10-11-12-13-14-15-17-19 mm
		9	T10-T15-T20-T25-T27-T30-T40-T45-T50
			Art. 1789
			Art. 3605



Empty tray for individual use.
Bandeja vacia para uso individual.
Bandeja vazia para uso individual.

	Art. 3601	9	1.5-2-2.5-3-4-5-6-8-10 mm
	Art. 4110-2 Art. 4110-3	2	0.4 x 2.5 mm - 0.9 x 5 mm
	Art. 4115-1 Art. 4115-2	2	PH 1-2
	Art. 4128		1/4"
	Art. 2138		110-250V
	Art. 3281-180		180 mm
	Art. 328-200		200 mm
	Art. 2221-251C		250 mm
	Art. 2240		150 mm
	Art. 2303		300 g
	Art. 1350-3		3 mm
	Art. 1358-2		No. 2
	Art. 4701-0316		3 m x 16 mm

Art.	1/4"	1/2"
3036	1/4" + 1/2"	1/4"

Professional ABS tool case

with 2 tool-pallets, solid aluminium frame and reinforced edges for shock-protection, snap-locks and numeric lock.

Maletín con ruedas y asa telescópica en ABS

con 2 paneles sin herramientas, estructura reforzada de aluminio con protección contra golpes, 2 cerraduras con llave y cerradura con código numérico.

Mala profissional em ABS

com chassis em alumínio sólido e proteção anti-choque, com 2 fechaduras, chaves e numérica.

Art.	⚖️
2998	5.2 kg



↕ 486 x 373 x 190 mm exterior

ABS

Professional trolley ABS tool case

with solid aluminium frame and reinforced edges on 2 in-line wheels with 2 tilting locks and extractable handle.

Maletín con ruedas en ABS

con esqueleto sólido en aluminio, bordes reforzados, 2 ruedas en línea, 2 cerraduras, asa telescópica.

Mala profissional tipo trolley em ABS

com protecção contra choques, 2 fechaduras, 2 rodas em linha e pega extensível.

Art.	⚖️
2995	6.7 kg



↕ 490 x 410 x 265 mm exterior

ABS

Metal tool box

of thick steel sheet, with 5 compartments.
European quality product.

Caja metálica

de plancha fina de acero, con 5 compartimentos
Producto de calidad europea.

Caixa de ferramenta

de chapa de aço grosso, com 5 divisórias.
Produto Europeu de qualidade.



Art.	±	Δ
3952	430 x 200 x 200 mm	5.8 kg
3950	530 x 200 x 200 mm	6.5 kg

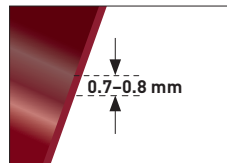

Stainless steel tool box

Caja para herramientas en acero inoxidable

Caixa de ferramentas em aço inoxidável

inox



Art.	±
3953	400 x 230 x 200 mm
3954	420 x 250 x 200 mm



Trolley tool backpack

- Made of robust and impermeable 600 denier polyester
- With telescope rubber handle
- With 3 compartments, side pockets and special laptop compartment
- Ideal as hand luggage on travels by air

Bolsas para herramientas

- Realizados en poliéster de 600 denier, resistente e impermeable
- 12 compartimentos externos y 8 internos para más capacidad
- Con cremallera
- Con asa y correa acolchada

Bolsas para ferramentas

- Fabricado em poliéster de 600 denier
- 12 bolsos externos e 8 internos para uma maior capacidade de armazenamento
- Com fecho
- Com alça almofadada e pegas



Art.	↕	max. Δ	L
3955	400 x 220 x 350 mm	15 kg	24
3956	510 x 360 x 400 mm	20 kg	42



Trolley tool backpack

- Made of robust and impermeable 600 denier polyester
- With telescopic rubber handle
- With 3 compartments, side pockets and special laptop compartment

Mochila con carrito

- Realizados en poliéster de 600 denier, resistente e impermeable
- Con mango telescópico en caucho
- Con 3 compartimentos, compartimentos laterales y compartimento para portátil

Mochila com trolley

- Fabricada em poliéster de 600 denier
- Com pega telescópica revestida a borracha
- Com 3 compartimentos, bolsos laterais e compartimento para computador portátil



Art.	↕	max. Δ	L
3957	350 x 200 x 550 mm	20 kg	20



Heavy duty tool bags with steel handle

- Made of robust and impermeable 1680 denier polyester
- Solid premium steel handle with ergonomic cushion
- With specially reinforced side panels
- Cover with zipper
- Numerous inside pockets
- Solid plastic bottom made of PVC
- With cushioned sling with strap

Bolsas para herramientas con asa metálica

- Realizados en poliéster de 1680 denier, resistente e impermeable
- Asa sólida en acero de alta calidad con cojín ergonómico
- Con los paneles laterales reforzados
- Cremallera
- Numerosos compartimentos interiores
- Fondo de plástico sólido de PVC
- Correa acolchada

Bolsa para ferramentas com pega metálica

- Fabricada em poliéster de 600 denier, resistente e impermeável
- Pega sólida em aço de alta qualidade com revestimento emborrachado
- Protecção com fecho
- Diversos bolsos interiores
- Fundo de plástico sólido em PVC
- Alça almofadada

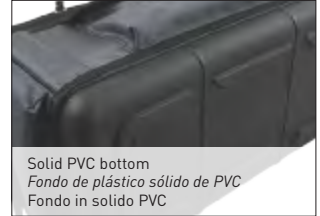
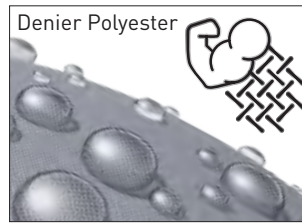

Heavy duty tool bag with steel handle

Bolsa para herramientas con asa metálica

Saco universal para ferramentas com pega de aço

Art.	↕	max. Δ	L
3958	390 x 210 x 300 mm	18 kg	10



Heavy duty tool bag with steel handle

Bolsa para herramientas con asa metálica

Saco universal para ferramentas com pega de aço









Art.	↕	max. Δ	L
3959	440 x 260 x 370 mm	23 kg	40



Tool bags with tools
Bolsas con herramientas
Sacos com ferramentas

Art.	±	max. ⚖️	L
3955-30	400 x 220 x 350 mm	15 kg	24
3956-30	510 x 360 x 400 mm	20 kg	42
3957-30	350 x 200 x 550 mm	20 kg	20
3958-30	390 x 210 x 300 mm	18 kg	10
3959-30	440 x 260 x 370 mm	23 kg	40

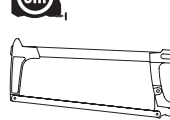

	10	8-9-10-11-12-13-14-15-17-19 mm
	10	T10-T15-T20-T25-T27 T30-T40-T45-T50
	3	0.6 x 3 mm 0.8 x 4 mm 1.0 x 5 mm
	2	PH 1-2
		180 mm
		250 mm
		300 g
		3 m x 19 mm
		300 mm

Magnetic aluminium socket rail

- Lightweight and compact
- Magnetic, no fixing by screws
- Corrosion-resistant
- You can combine your individual socket-composition
- Clips/sockets 1/4", 3/8", 1/2" can be combined on the same rail

Regleta magnética de aluminio para vasos





- Ligera y compacta
- Magnética, no necesita tornillos
- Resistente a la corrosión
- Puede realizar su composición individual de vasos
- Posibilidad de combinar en la misma regleta clips/vasos de 1/4", 3/8", 1/2"

Suporte magnético em alumínio para chaves

- Leve e compacto
- Magnético, sem parafusos de fixação
- Resistente a corrosão
- Pode fazer a sua composição individual de chaves
- Clips/Chaves 1/4", 3/8", 1/2" podem ser combinadas no mesmo suporte



COMBI socket wrench set
Juego de llaves de vaso COMBI
Jogo de chaves de caixa COMBI

- | | | | |
|---|-------------------------------|---|------------------|
|  | 4-4.5-5-5.5-6-7-8 |  | E5-E6-E8-E10-E12 |
| mm | 9-10-11-12-13-14 mm | TX | E14-E16-E18 |
|  | 5/32"-7/32"-1/4"-5/32"-5/16" |  | M5-M6-M8-M9-M10 |
| inch | 11/32"-3/8"-7/16"-15-32"-1/2" | XZN | M12-M14-M16-M18 |



Art.	⊙	L mm
130990	1/4"	25



Inch socket wrench set
Juego de llaves de vaso pulgadas
Jogo de chaves de caixa polegadas



Art.	⊙	L mm
100599	1/4"	25



Deep socket wrench set
Juego de llaves de vaso largo
Jogo de chaves de caixa longa

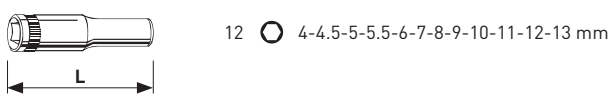

Art.	⊙	L mm
101990	1/4"	50

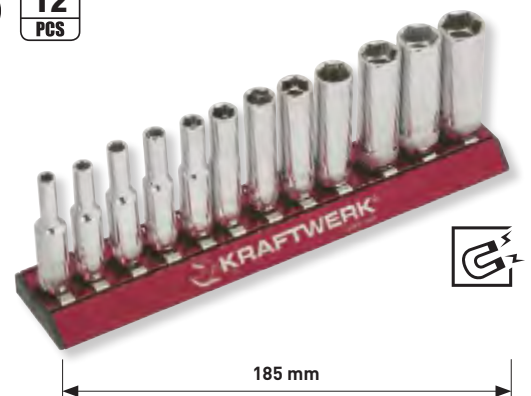

Inch deep socket wrench set

Juego de llaves de vaso largas pulgadas

Jogo de chaves de caixa longa polegadas

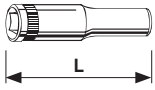

9 ○ 3/16"-7/32"-1/4"-9/32"-5/16"
11/32"-3/8"-7/16"-1/2"

Art.	○	L mm
101599	1/4"	50

External TX socket wrench set

Juego de llaves de vaso TX exterior

Jogo de chaves de caixa TX exterior



7 ☼ E4-E5-E6-E7-E8-E10-E11

Art.	○	L mm
120099	1/4"	25

TX bit-socket wrench set

Juego de llaves de vaso con punta TX

Jogo de chaves de caixa com bit TX

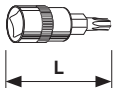

8 ☼ T8-T10-T15-T20-T25-T27-T30-T40

Art.	○	L mm
105099	1/4"	38

5-star TX bit-socket set

Juego de llaves de vaso con punta TX 5 puntas

Jogo de chaves de caixa com bit TX 5 pontas

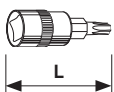

9 ☼ TS8-TS9-TS10-TS15-TS20
TS25-TS27-TS30-TS40

Art.	○	L mm
115099	1/4"	38

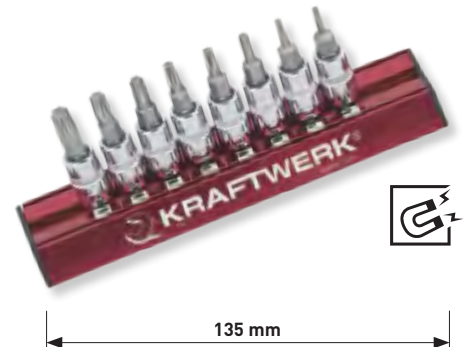

5-star taper TX bit-socket set

Juego de llaves de vaso con punta

TX seguridad de 5 puntas

Jogo de chaves de caixa com bit taper TX 5 pontas

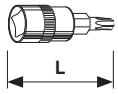

9 TS8-TS9-TS10-TS15-TS20
TS25-TS27-TS30-TS40

Art.		L mm
115399	1/4"	38

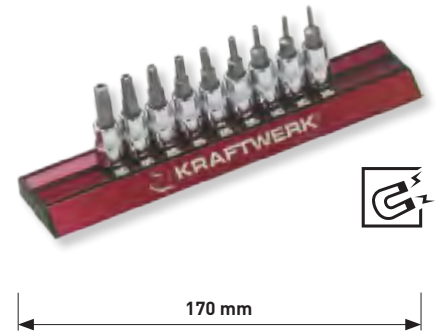

Hexagonal bit-socket wrench set

Juego de llaves de vaso con punta hexagonal

Jogo de chaves de caixa com bit sextavado

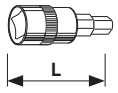

6 3-4-5-6-7-8 mm

Art.		L mm
106099	1/4"	38

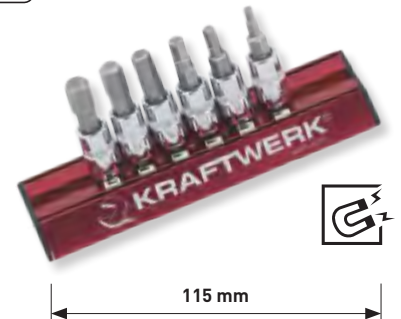

Inch hexagonal bit-socket wrench set

Juego de llaves de vaso con punta hexagonal

pulgadas
Jogo de chaves de caixa com bit sextavado em
polegadas

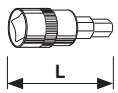

5 1/8"-5/32"-3/16"-7/32"-1/4"

Art.		L mm
106599	1/4"	38



Inch socket wrench set

Juego de llaves de vaso pulgadas

Jogo de chaves de caixa polegadas

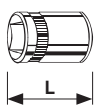

12 5/16"-3/8"-7/16"-1/2"-9/16"-5/8"
11/16"-3/4"-13/16"-7/8"-15/16"-1"

Art.		L mm
200599	3/8"	25



Deep socket wrench set

Juego de llaves de vaso largo

Jogo de chaves de caixa longa

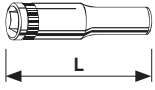

11 ○ 8-10-11-12-13-14-15-17-18-19-22 mm

Art.	○	L mm
201990	3/8"	64

Spark plug socket wrench set

Juego de llaves de vaso para bujías

Jogo de chaves de caixa de velas

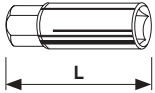

3 ○ 16-18-21 mm

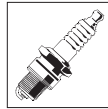

Art.	○	L mm
201998	3/8"	64-65-70

Inch deep socket wrench set

Juego de llaves de vaso largo pulgadas

Jogo de chaves de caixa longa polegadas

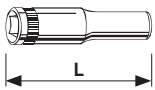

7 ○ 3/8"-7/16"-1/2"-9/16"-11/16"-3/4"-7/8"

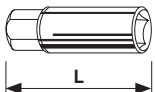

2 ○ 5/8"-13/16"

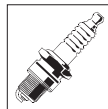

Art.	○	L mm
201599	3/8"	64

External TX socket wrench set

Juego de llaves de vaso TX exterior

Jogo de chaves de caixa TX-exterior

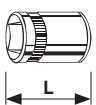

12 ☆ E4-E5-E6-E7-E8-E10-E11
E12-E14-E16-E18-E20

Art.	○	L mm
220099	3/8"	28

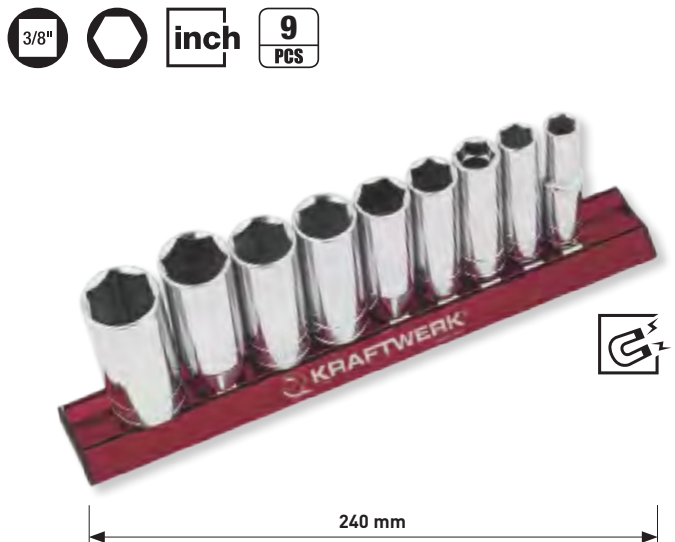
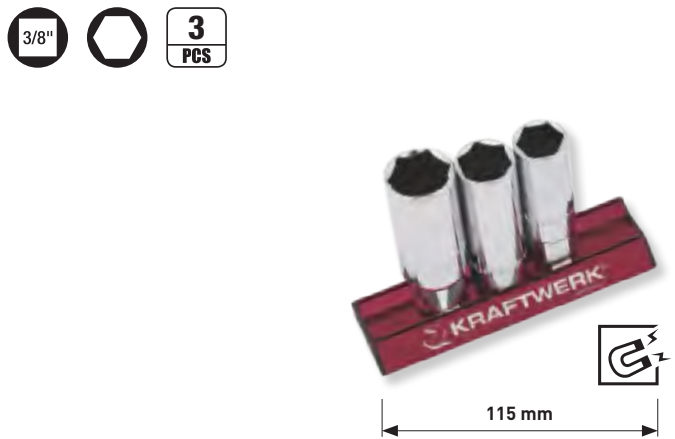

TX bit-socket wrench set

Juego de llaves de vaso con punta TX

Jogo de chaves de caixa com bit TX

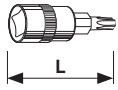

11 T10-T15-T20-T25-T27-T30
T40-T45-T50-T55-T60

Art.		L mm
205099	3/8"	48

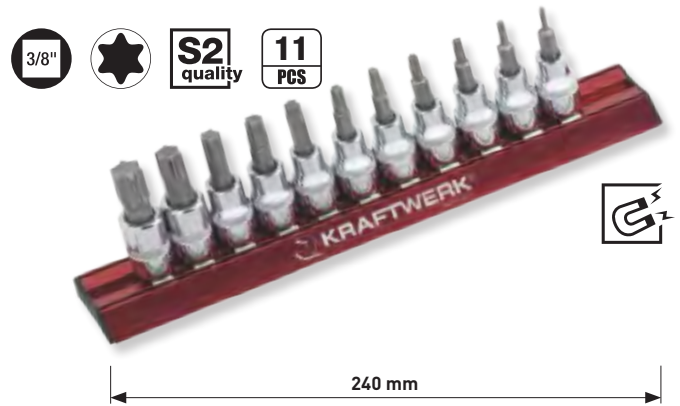

Tamper TX bit-socket wrench set

Juego de llaves de vaso con punta TX seguridad

Jogo de chaves de caixa com bit tamper TX

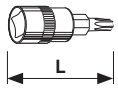

11 T10-T15-T20-T25-T27-T30
T40-T45-T50-T55-T60

Art.		L mm
205399	3/8"	48



Hexagonal bit-socket wrench set

Juego de llaves de vaso con punta hexagonal

Jogo de chaves de caixa com bit sextavado

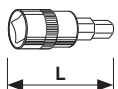

7 3-4-5-6-7-8-10 mm

Art.		L mm
206099	3/8"	48

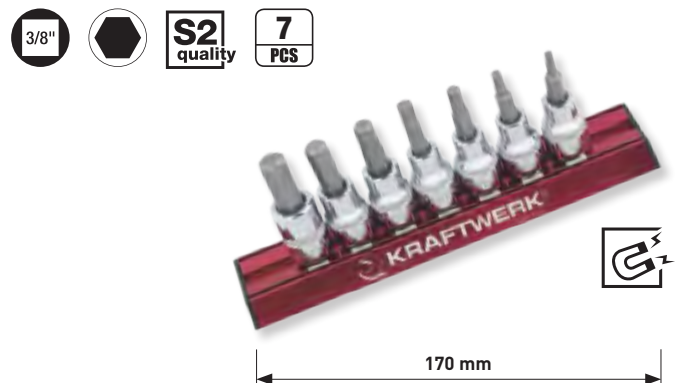

Inch hexagonal bit-socket wrench set

Juego de llaves de vaso con punta hexagonal pulgadas

Jogo de chaves de caixa com bit sextavado em polegadas

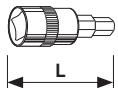



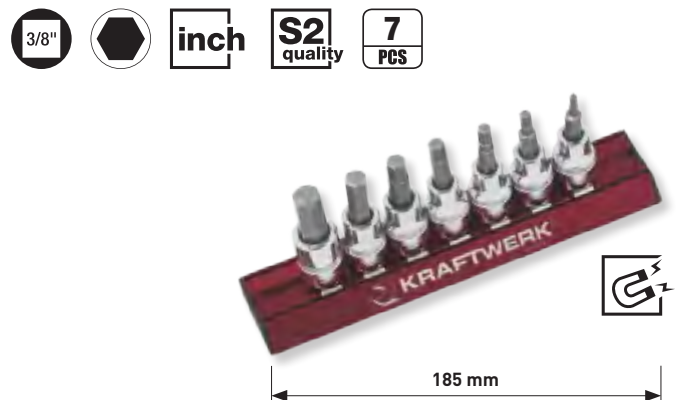

7 1/8"-5/32"-3/16"-7/32"-1/4"-5/16"-3/8"

Art.		L mm
206599	3/8"	48



COMBI socket wrench set
Juego de llaves de vaso COMBI
Jogo de chaves de caixa COMBI

1/2"  **10**
PCS



- | | | | |
|---|--|---|--------------------------------|
|  | 10-11-12-13-14
15-16-17-18-19 mm |  | E12-E14-E16-E18
E20-E22-E24 |
|  | 3/8"-7/16"-15/32"-1/2"
19/32"-5/8"-3/4" |  | XZN M12-M14-M16-M18 |



Art.		L mm
330990	1/2"	38

COMBI socket wrench set
Juego de llaves de vaso COMBI
Jogo de chaves de caixa COMBI

1/2"  **7**
PCS

- | | | | |
|---|---|---|----------------------------|
|  | 20-21-22-24-27-30-32 mm |  | E26-E28-E30-E34
E38-E40 |
|  | 25/32"-13/16"-7/8"-15/16"
1-1/16"-1-3/16"-1-1/4" | | |



Art.		L mm
330991	1/2"	42

Deep socket wrench set
Juego de llaves de vaso largo
Jogo de chaves de caixa longa

1/2"  **11**
PCS



Art.		L mm
301990	1/2"	77

Spark plug socket wrench set
Juego de llaves de vaso para bujías
Jogo de chaves de caixa de velas

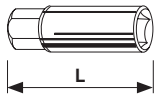

2 ○ 16-21 mm

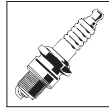

Art.	○	L mm
301998	1/2"	64-70

Deep impact socket wrench set
Juego de llaves de vaso largo de impacto
Jogo de chaves de caixa longa impacto



3 ○ 17-19-21 mm

Art.	○	L mm
381099	1/2"	85

External TX socket wrench set
Juego de llaves de vaso TX exterior
Jogo de chaves de caixa TX-exterior

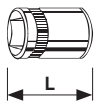

8 ☆ E10-E12-E14-E16-E18-E20-E22-E24

Art.	○	L mm
320099	1/2"	40

TX bit-socket wrench set
Juego de llaves de vaso con punta TX
Jogo de chaves de caixa com bit TX

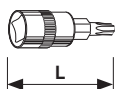

12 ☆ T10-T15-T20-T25-T27-T30
T40-T45-T50-T55-T60-T70

Art.	○	L mm
325099	1/2"	56

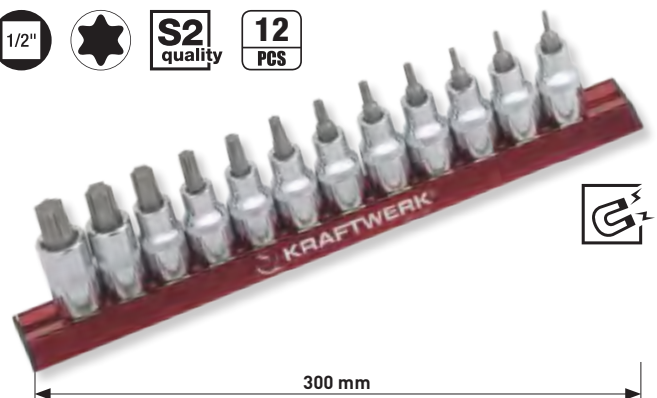

TX bit-socket wrench set

Juego de llaves de vaso con punta TX

Jogo de chaves de caixa com bit TX

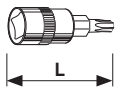

1/4" 7
1/2" 6



T8-T10-T15-T20-T25-T27-T30
T40-T45-T50-T55-T60-T70

Art.	Ø	L mm
99045	1/4" 1/2"	37 56

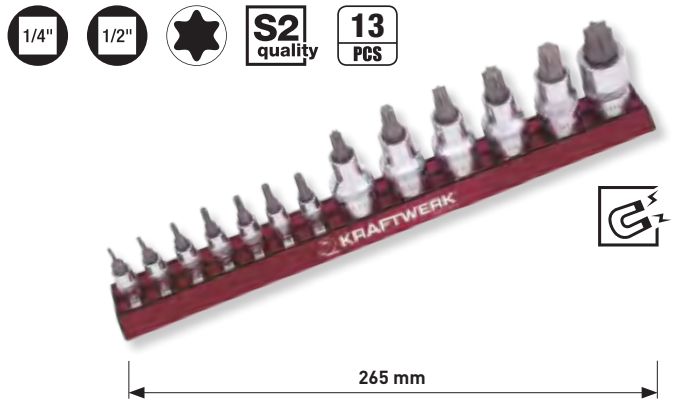

Long TX bit-socket wrench set

Juego de llaves de vaso largo con punta TX

Jogo de chaves de caixa com bit longas TX

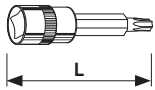

10



T10-T15-T20-T25-T27
T30-T40-T45-T50-T55

Art.	Ø	L mm
335099	1/2"	100

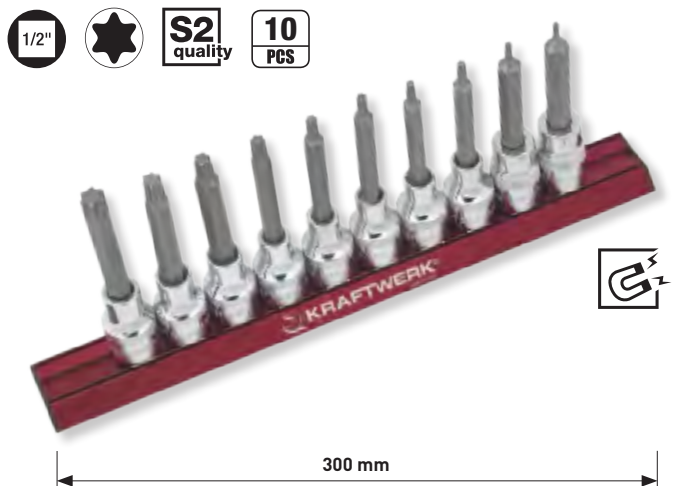

Hexagonal bit-socket wrench set

Juego de llaves de vaso con punta hexagonal

Jogo de chaves de caixa com bit sextavado

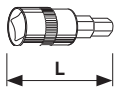

8



5-6-7-8-10-12-14-17 mm

Art.	Ø	L mm
326099	1/2"	56

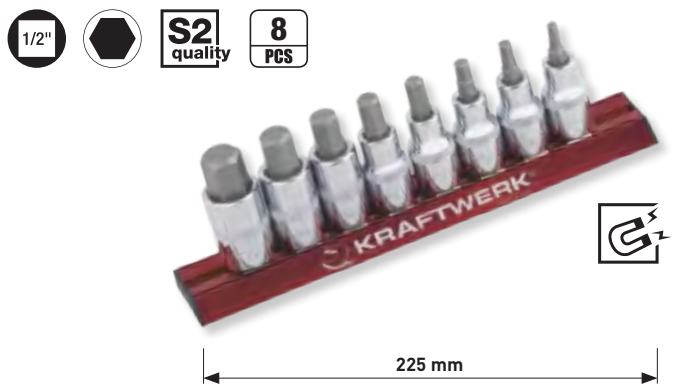

Hexagonal bit-socket wrench set

Juego de llaves de vaso con punta hexagonal

Jogo de chaves de caixa com bit sextavado

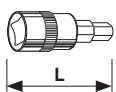

1/4" 5
1/2" 5



3-4-5-6-7 mm
8-10-12-14-17 mm

Art.	Ø	L mm
99046	1/4" 1/2"	37 56

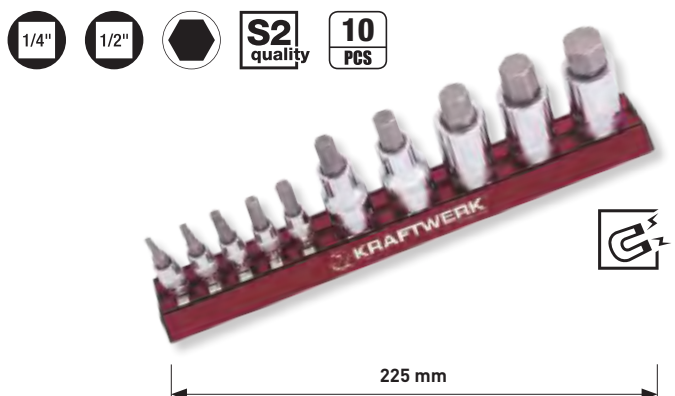

Long hexagonal bit-socket wrench set
Juego de llaves de vaso largo con punta hexagonal
Jogo de chaves de caixa com bit longo sextavado

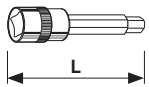

6 ● 5-6-7-8-10-12 mm

Art.	Ø	L mm
336099	1/2"	100



XZN bit-socket wrench set
Juego de llaves de vaso con punta XZN
Jogo de chaves de caixa com bit XZN

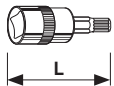

7 ● M5-M6-M8-M10-M12-M14-M16

Art.	Ø	L mm
328099	1/2"	55



Long XZN bit-socket wrench set
Juego de llaves de vaso largo con punta XZN
Jogo de chaves de caixa com bit longo XZN

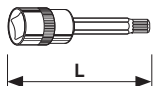

5 ● M5-M6-M8-M10-M12

Art.	Ø	L mm
338099	1/2"	100

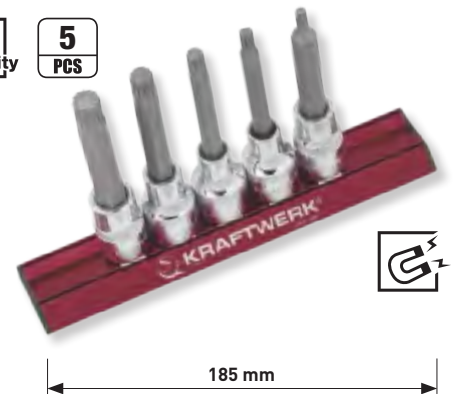

Tamper RIBE bit-socket set
Juego de llaves de vaso con punta RIBE de seguridad
Jogo de chaves de caixa com bit tamper RIBE

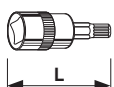

10 ● M5-M6-M7-M8-M9-M10
M11-M12-M13-M14

Art.	Ø	L mm
329099	1/2"	55



Long taper RIBE bit-socket set

Juego de llaves de vaso largo con punta RIBE de seguridad

Jogo de chaves de caixa com bit longo taper RIBE

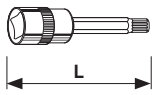

10 M5-M6-M7-M8-M9-M10
M11-M12-M13-M14

Art.	Ø	L mm
339099	1/2"	100

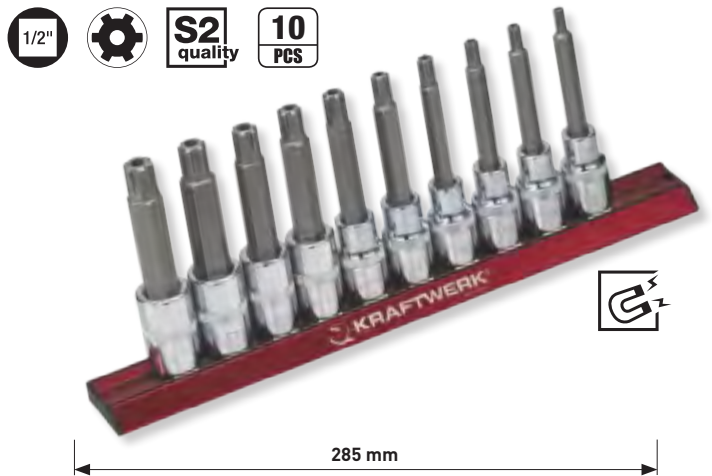

Magnetic aluminium socket rail

Regleta magnética aluminio

Suporte magnético de alumínio

Art.	L mm	
3090	115	1/4" - 3/8" - 1/2"
3091	185	1/4" - 3/8" - 1/2"
3092	240	1/4" - 3/8" - 1/2"
3093	300	1/4" - 3/8" - 1/2"

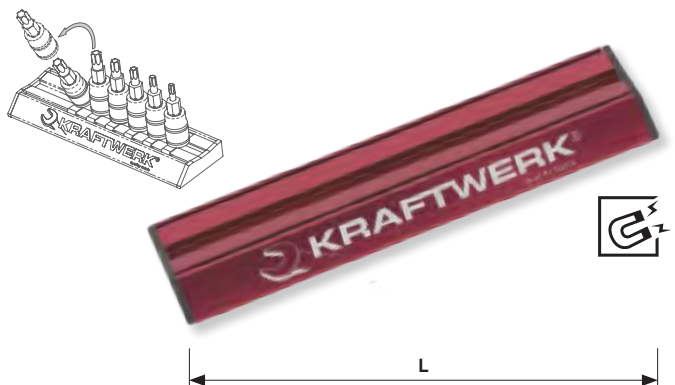

Socket rail clips

Bags of 10 pieces

Clips para regleta magnética

Bolsitas de 10 piezas

Clips para suporte magnético

Bolsa de 10 peças

Art.		
3094	10 pcs	1/4"
3094B	bulk, a granel, avulso	1/4"
3095	10 pcs	3/8"
3095B	bulk, a granel, avulso	3/8"
3096	10 pcs	1/2"
3096B	bulk, a granel, avulso	1/2"

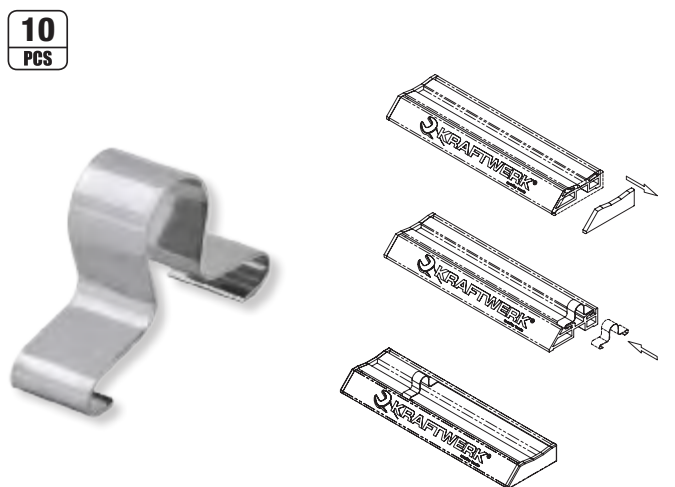

Socket rail

with 16 clips

Regleta para vasos

con 16 clips

Suporte para chaves

com 16 Clips

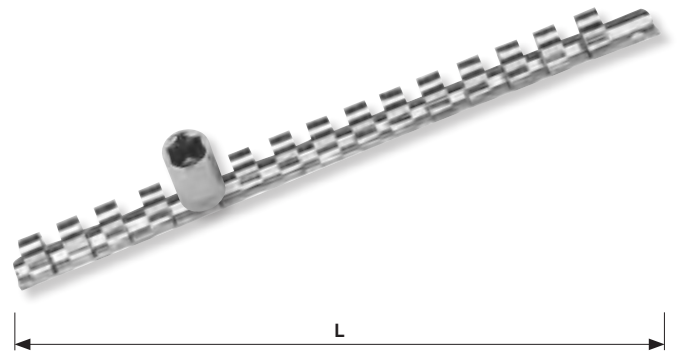

Art.	Ø	L mm	
3097	1/4"	250	16
3098	3/8"	250	16
3099	1/2"	250	10



Reversible ratchet handle
Carraca reversible
Roquete manual reversível



ERGOKRAFT

Art.	□	L mm	
3200	1/4"	145	
3204	1/4"	Stubby model / <i>Modelo corto</i> / <i>Modelo curto</i>	110
3200E	1/4"	Repair kit / <i>Kit reparación</i> / <i>Kit de reparação</i>	-
3210	3/8"	205	
3214	3/8"	Stubby model / <i>Modelo corto</i> / <i>Modelo curto</i>	135
3210E	3/8"	Repair kit / <i>Kit reparación</i> / <i>Kit de reparação</i>	-
3220	1/2"	255	
3220E	1/2"	Repair kit / <i>Kit reparación</i> / <i>Kit de reparação</i>	-

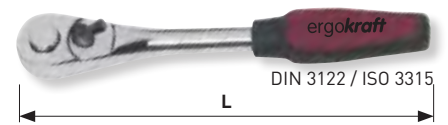

Fine teeth ratchet handle
Carraca reversible dentado fino
Roquete manual de dentes finos



Art.	□	L mm	
4009	1/4"	145	
4009E	1/4"	Repair kit / <i>Kit reparación</i> / <i>Kit de reparação</i>	-
4019	3/8"	210	
4019E	3/8"	Repair kit / <i>Kit reparación</i> / <i>Kit de reparação</i>	-
4029	1/2"	245	
4029E	1/2"	Repair kit / <i>Kit reparación</i> / <i>Kit de reparação</i>	-



Extendable fine teeth ratchet handle
Carraca reversible dentado fino extensible
Roquete extensível de dentes finos



Art.	□	L mm	
2000	1/4"	148 - 198	
2000E	1/4"	Repair kit / <i>Kit reparación</i> / <i>Kit de reparação</i>	-
2010	3/8"	215 - 315	
2010E	3/8"	Repair kit / <i>Kit reparación</i> / <i>Kit de reparação</i>	-
2020	1/2"	307 - 447	
2020E	1/2"	Repair kit / <i>Kit reparación</i> / <i>Kit de reparação</i>	-



Mini fine teeth ratchet handle
Mini carraca reversible dentado fino
Mini roquete manual de dientes finos

Art.		L mm
3006	1/4"	95

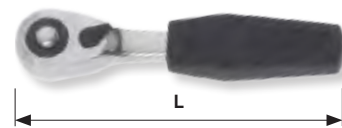

Micro ratchet handle
Micro carraca reversible
Micro roquete manual

Art.		L mm
3201B	1/4"	107 mm



Micro flexible ratchet handle set
Juego micro carracas reversibles articuladas
Jogo de micro roquetes flexível

Art.			L mm
3201F	1/4"	1/4"	108 mm

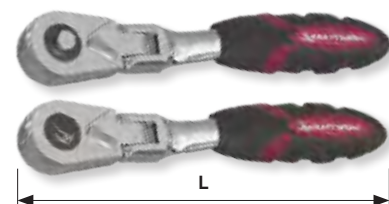

Heavy duty reversible ratchet handle
Carraca reversible industrial
Roquete manual reversível de grande torque

Art.		L mm
4000	1/4"	153
4010	3/8"	217
4020	1/2"	261

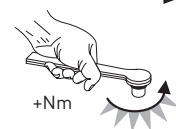

HIGHTECH FINE POWER Fine-tooth reversible ratchet handle

Carraca reversible de precisión HIGHTECH FINE POWER

Roquete de dentes finos reversível HIGHTECH FINE POWER

1/4"

3/8"

1/2"

120

HIGHTECH FINE POWER

Art.	■	L mm
4001	1/4"	143
4001E	1/4"	Repair kit / <i>Kit reparación</i> / Kit de reparação
4011	3/8"	205
4011E	3/8"	Repair kit / <i>Kit reparación</i> / Kit de reparação
4021	1/2"	260
4021E	1/2"	Repair kit / <i>Kit reparación</i> / Kit de reparação



Composite ratchet handle

Carraca reversible en material compuesto

Roquete manual em compósito

1/4"

3/8"

1/2"

48



Art.	■	L mm
3206	1/4"	143
3206E	1/4"	Repair kit / <i>Kit reparación</i> / Kit de reparação
3216	3/8"	205
3216E	3/8"	Repair kit / <i>Kit reparación</i> / Kit de reparação
3226	1/2"	260
3226E	1/2"	Repair kit / <i>Kit reparación</i> / Kit de reparação

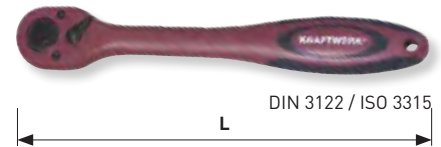

Art. 3206E / 3216E / 3226E

Reversible twister ratchet handle

For work under confined space conditions. 60 fine-tooth ratchet with zero-degree twist arc swing handle. Square socket in handle for extension bar or t-handle. Also suitable as a conventional ratchet with insertable square socket for forward and reverse transition.

Carraca reversible con mango giratorio

Especialmente para los sitios estrechos sin espacio para girar. Mango ergonómico bimaterial. Cuadradillo en mango para alargaderas o barras "T". También utilizable como carraca normal de dentado fino (60 dientes). Función derecha/izquierda pulsando el cuadradillo.

Roquetes reversíveis com punho rotativo

para locais estreitos e sem espaço para rodar. O quadrado é movido sem ângulo de retorno por torção do punho. Encaixe no punho para barra de extensão ou manipulo T. Utilizável como roquete normal com dentes finos (60 dentes). Alternância entre direita e esquerda por pressão do encavador.



Art.	■	○	L mm
3208	1/4"	60	180
3218	3/8"	60	240
3228	1/2"	60	290

Mini reversible ratchet handle set

with ratchet handle for 1/4" sockets and 1/4" direct drive bits, in elegant aluminium box.

Juego de mini carracas reversibles

con carraca 1/4" para vasos y carraca para puntas. En caja de aluminio.

Jogo de roquetes reversíveis mini

para chaves de caixa e bits (1/4 "). Em caixa de alumínio.

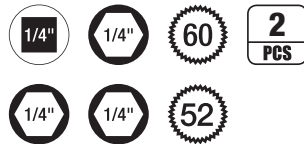

142 x 38 x 25 mm

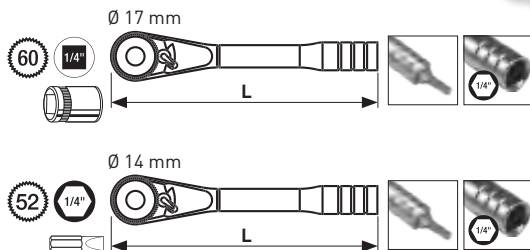

Art.	■	○	L mm
4004RS	1/4"	52 / 60	95

Reversible mini ratchet handle
Mini carraca reversible
Roquete reversível mini



Art.	■ ○	○	L mm
4004R1	1/4"	60	95

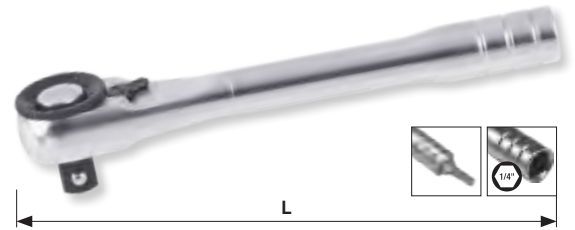

Reversible mini bit ratchet handle
Mini carraca reversible
Roquete reversível mini de bits



Art.	○ ○	○	L mm
4004R2	1/4"	52	95

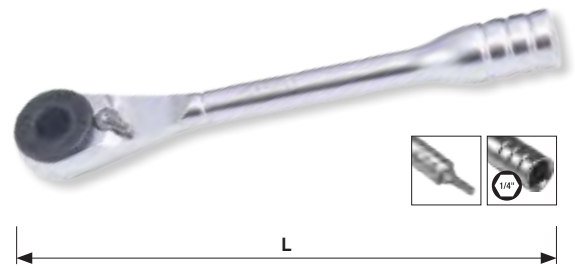

Heavy duty reversible ratchet handle
Carraca reversible para trabalho pesado
Roquete reversível para trabalhos pesados



Art.	■	L mm
400002	3/4"	500
400003	3/4"	Telescope Telescópico Telescópico 500 - 800
400002E	3/4"	Repair kit / Kit reparación / Kit de reparação -

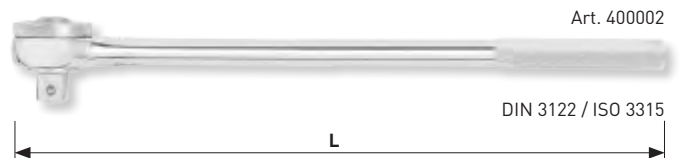

Art. 400002E

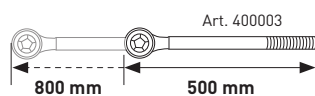

Extendable heavy duty reversible ratchet handle
Carraca reversible y extensible para trabajo pesado
Roquete reversível e extensível para trabalhos pesados

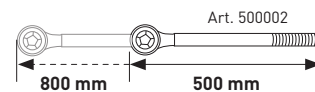

Art.	■	L mm
500002	1"	500 - 800
500002E	1"	Repair kit / Kit reparación / Kit de reparação



Pass through reversible ratchet handle
Carraca reversible pasante
Roquete manual de aperto reversível



Art.	○	L mm
590000	13 mm	145
600000	20 mm	204
610000	30 mm	267



Click torque wrench

precise, with window scale for values in Nm and Lb.in.
Instant reversible 45 teeth ratchet head. Hardened steel casing and ergonomic 2-component handle with locking adjusting knob. Certified precision: +/- 4 %.

Llave dinamométrica click

de precisión con ventana y valores en Nm y Lb.in.
Carraca reversible instantánea 45 dientes. Carcasa en acero reforzado y mango ergonómico bimaterial con botón de ajuste. Precisión certificada: +/- 4 %.

Chave dinamométrica

de precisão com janela de escala para valores em Nm e Lb.in.
Reversível instantâneo com cabeça de 45 dentes em aço endurecido e punho ergonómico de 2 componentes com bloqueio ajustável. Precisão certificada: +/- 4 %.

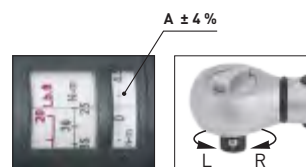
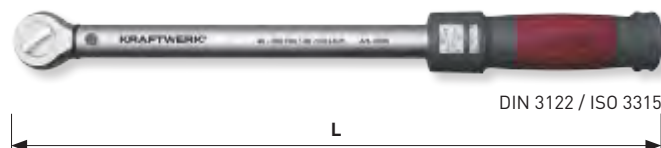

Art.	■	<~>	A Nm	L mm
3231	1/4"	2.5 - 12 Nm 20 - 105 Lb.in	0.05	285
3232	1/4"	4 - 20 Nm 30 - 180 Lb.in	0.05	285
3233	3/8"	10 - 60 Nm 9 - 45 Lb.ft	0.125	383
3234	3/8"	25 - 125 Nm 20 - 90 Lb.ft	0.25	438
3235	1/2"	40 - 200 Nm 30 - 150 Lb.ft	0.5	463
3236	1/2"	65 - 335 Nm 50 - 250 Lb.ft	0.5	523
3237	3/4"	160 - 800 Nm 120 - 600 Lb.ft	2.0	1040

Repair kit

Kit reparación

Kit de reparação

Art.	■	for / para / para
3232E	1/4"	Art. 3232
3233-34E	3/8"	Art. 3233, 3234
3235-36E	1/2"	Art. 3235, 3236
3237E	3/4"	Art. 3237



Reversible torque wrench case

with sockets and hexagonal bit-sockets

Estuche llave dinamométrica reversible

con vasos y vasos-punta hexagonal

Jogo de chave dinamométrica reversível

com chaves de caixa e chaves de caixa com bit sextavado interior

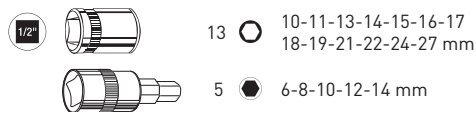

Art.	■	< ~ >
3235K1	1/2"	40 - 200 Nm 30 - 150 Lb.ft
3236K1	1/2"	65 - 335 Nm 50 - 250 Lb.ft



620 x 169 x 65 mm

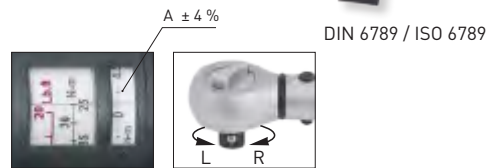

DIN 6789 / ISO 6789

Reversible torque wrench case

with sockets, hexagonal bit-sockets and deep impact sockets

Estuche llave dinamométrica reversible

con vasos, vasos-punta hexagonal y vasos de impacto extra largos

Jogo de chave dinamométrica reversível

com chaves de caixa, chaves de caixa com bit sextavado interior e chaves de caixa de impacto extra-longas

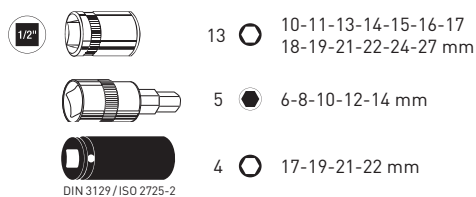

Art.	■	< ~ >
3235K2	1/2"	40 - 200 Nm 30 - 150 Lb.ft
3236K2	1/2"	65 - 335 Nm 50 - 250 Lb.ft



620 x 169 x 65 mm

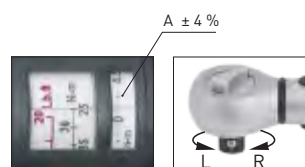

DIN 6789 / ISO 6789

Reversible torque wrench case

with sockets, hexagonal bit-sockets and deep impact sockets with plastic sleeves for aluminium wheels

Estuche llave dinamométrica reversible

con vasos, vasos-punta hexagonal y vasos de impacto extra largos revestidos de protección plástica para llantas de aleación

Jogo de chave dinamométrica reversível

com chaves de caixa, chaves de caixa com bit sextavado interior e chaves de caixa de impacto extra-longas revestidas de plástico para jantes alumínio

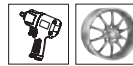
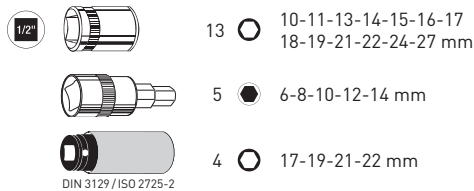

620 x 169 x 65 mm

DIN 6789 / ISO 6789

Art.	■	< ~ >
3235K3	1/2"	40 - 200 Nm 30 - 150 Lb.ft
3236K3	1/2"	65 - 335 Nm 50 - 250 Lb.ft

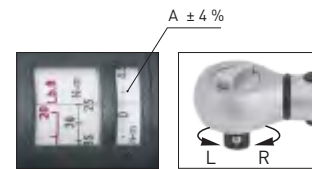

Click torque bar

precise, with window scale for values in Nm and Lb.ft.

Rectangular drive for exchangeable wrench heads 14 x 18 mm.

Hardened steel casing and ergonomic 2-component handle with locking adjusting knob.

Certified precision: +/- 4 %.

Barra dinamométrica click

de precisión con ventana y valores en Nm y Lb.ft.

Unión rectangular para bocas de llaves 14 x 18 mm.

Carcasa en acero reforzado y mango ergonómico bimaternal con botón de ajuste.

Precisión certificada: +/- 4 %.

Barra dinamométrica

de precisão com janela de escala para valores em Nm e Lb.ft.

Encavadura sextavada para chaves 14 x 18 mm.

Em aço endurecido e punho ergonómico de 2 componentes com bloqueio ajustável.

Precisão certificada: +/- 4 %



Art. 3235H



Art. 3236H

Art.	○	< ~ >
3235H	14 x 18 mm	40 - 200 Nm 30 - 150 Lb.ft
3236H	14 x 18 mm	65 - 335 Nm 50 - 250 Lb.ft

Torque wrench case

with open end heads and reversible heavy duty ratchet head

Estuche llave dinamométrica

con bocas de llaves fijas y carraca reversible dentado fino

Jogo de chave dinamométrica

com chaves de boca e roquete reversível industrial



620 x 169 x 65 mm

DIN 6789 / ISO 6789

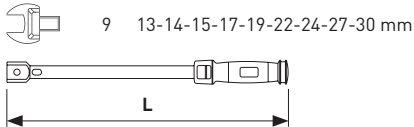

Art.		for / para / para	<-->	L mm
3235GK1	14 x 18 mm 1/2"	reversible heavy duty ratchet head <i>carraca reversible industrial</i> roquete reversível industrial	40 - 200 Nm 30 - 150 Lb.ft	463
3236GK1	14 x 18 mm 1/2"	reversible heavy duty ratchet head <i>carraca reversible industrial</i> roquete reversível industrial	65 - 335 Nm 50 - 250 Lb.ft	523
3235GK2	14 x 18 mm 1/2"	reversible fine teeth ratchet head <i>carraca reversible dentado fino</i> roquete reversível de dentes finos	40 - 200 Nm 30 - 150 Lb.ft	463
3236GK2	14 x 18 mm 1/2"	reversible fine teeth ratchet head <i>carraca reversible dentado fino</i> roquete reversível de dentes finos	65 - 335 Nm 50 - 250 Lb.ft	523

Interchangeable open end head

for torque wrenches 3235H / 3236H

Boca intercambiable de llave fija

para llaves dinamométricas 3235H / 3236H

Chave de boca intercambiável

para chaves dinamométricas 3235H / 3236H



Art.		
3235-G13	14 x 18 mm	13 mm
3235-G14	14 x 18 mm	14 mm
3235-G15	14 x 18 mm	15 mm
3235-G17	14 x 18 mm	17 mm
3235-G19	14 x 18 mm	19 mm
3235-G22	14 x 18 mm	22 mm
3235-G24	14 x 18 mm	24 mm
3235-G27	14 x 18 mm	27 mm
3235-G30	14 x 18 mm	30 mm

Torque wrench case

with ring end heads and reversible heavy duty ratchet head

Estuche llave dinamométrica

con bocas de llaves poligonales y carraca reversible industrial

Jogo de chave dinamométrica

com chaves luneta e roquete reversível industrial

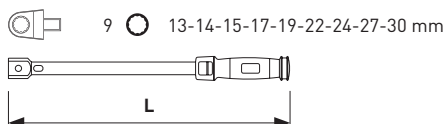

620 x 169 x 65 mm

DIN 6789 / ISO 6789

Art.	for / para / para	< - >	L mm	
3235RK1	14 x 18 mm 1/2"	reversible heavy duty ratchet head <i>carraca reversible industrial</i> roquete reversível industrial	40 - 200 Nm 30 - 150 Lb.ft	463
3236RK1	14 x 18 mm 1/2"	reversible heavy duty ratchet head <i>carraca reversible industrial</i> roquete reversível industrial	65 - 335 Nm 50 - 250 Lb.ft	523
3235RK2	14 x 18 mm 1/2"	reversible fine teeth ratchet head <i>carraca reversible dentado fino</i> roquete reversível de dentes finos	40 - 200 Nm 30 - 150 Lb.ft	463
3236RK2	14 x 18 mm 1/2"	reversible fine teeth ratchet head <i>carraca reversible dentado fino</i> roquete reversível de dentes finos	65 - 335 Nm 50 - 250 Lb.ft	523

Interchangeable ring end head

for torque wrenches 3235H / 3236H

Boca intercambiable de llave poligonal

para llaves dinamométricas 3235H / 3236H

Chave luneta intercambiável

para chaves dinamométricas 3235H / 3236H





Art.		
3235-R13	14 x 18 mm	13 mm
3235-R14	14 x 18 mm	14 mm
3235-R15	14 x 18 mm	15 mm
3235-R17	14 x 18 mm	17 mm
3235-R19	14 x 18 mm	19 mm
3235-R22	14 x 18 mm	22 mm
3235-R24	14 x 18 mm	24 mm
3235-R27	14 x 18 mm	27 mm
3235-R30	14 x 18 mm	30 mm



Reversible heavy duty ratchet head
for torque bars

Boca de carraca reversible industrial
para barras dinamométricas

Roquete reversível industrial
para barras dinamométricas



Art.			
3235-U12P	24	14 x 18 mm	1/2"



Reversible fine teeth ratchet head
for torque bars

Boca de carraca reversible dentado fino
para barras dinamométricas

Cabeça de roquete reversível de dentes finos
para barras dinamométricas

Art.			
3235-U12R	72	14 x 18 mm	1/2"



Torque wrench



with fine scale graduation in Nm and lbf-in. Hardened steel housing with integrated switch lever and freewheel function.

Llave dinamométrica

con graduación en Nm y lbf-in. Cuerpo de acero endurecido con mango de ajuste de una sola pieza y con función de rueda libre.

Chave Dinamométrica

com escala fina graduada em Nm e lbf-in. Corpo em aço reforçado e patilha integrada com função de rotação livre.

Art.			L mm
2045	1/2"	42 - 210 Nm 31 - 154.9 Lb.ft	450
2045E	1/2"	Repair kit Kit reparación Kit de reparação	



DIN ISO 6789



QUICKLOCK

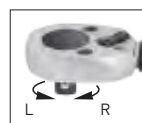

Art. 2045E

Impact torque limiting extension bar set
for limiting the torque while using impact wrenches.

Set alargaderas limitadoras de par de impacto
para limitar el par al usarlo con las pistolas de impacto.

Conjunto de extensões de impacto limitadoras de binário

para limitação de binário durante a utilização de pistolas pneumáticas.



- 110 Nm - 80 Lb.ft
- 120 Nm - 90 Lb.ft
- 135 Nm - 100 Lb.ft
- 150 Nm - 110 Lb.ft

Art.			L mm
387200	1/2"	1/2"	200



Canvas

Electronic torque-adapter

Can be used as a torque adapter with every drive element like e.g. conventional reversible ratchet handles.

- Automatic zero positioning at switching on
- Direct measuring indication or set point programming with a visual and acoustic warning at reaching or exceeding of the set point
- Track-/Peak-Mode
- Measuring accuracy: $\pm 2\%$ tolerance
- 50 memories
- incl. batteries and test certificate DIN EN ISO 6789.



DIN EN ISO 6789



Adaptador dinamométrico electrónico

puede ser utilizado como adaptador de fuerza con todo tipo de elementos como por ejemplo las llaves convencionales de carraca reversibles.

- Posicionamiento automático a cero al encender
- Indicador directo de medición o programación del punto de fuerza establecido con aviso visual y acústico al llegar o superar el mismo
- Modo pista/ punto máximo
- Precisión: $\pm 2\%$
- 50 memorias
- Incluye pilas y certificado DIN EN ISO 6789.

Adaptador electrónico torque

pode ser usado com qualquer roquete reversível ou rabo de força com quadra.

- Posição zero automática no botão ligar
- Indicação de medição direta ou programação do ponto de ajuste com aviso visual e acústico ao alcançar ou excedendo o ponto de ajuste
- Modo de procura
- Tolerância de erro $\pm 2\%$
- 50 memórias
- Inclui baterias e certificado de teste DIN EN ISO 6789.



kg-m / kg-cm / lb-in / Lb.ft

Art.	■	< ~ > $\pm 2\%$	3V Li-Mn CR-2032	⊕	B x L x H mm
4081-14	1/4"	6 - 30 Nm 4.4 - 22.1 Lb.ft	1x	55 h	122 x 190 x 64 (BMC)
4081-38	3/8"	27 - 135 Nm 19.9 - 99.6 Lb.ft	1x	55 h	122 x 190 x 64 (BMC)
4081-12	1/2"	40 - 200 Nm 29.5 - 147.5 Lb.ft	1x	55 h	122 x 190 x 64 (BMC)
Art.	■	< ~ > $\pm 2\%$	1.5V LR6-AA	⊕	L x B x H mm
4081-34	3/4"	100 - 500 Nm 73.8 - 369 Lb.ft	2x	110 h	156 x 110 x 80 (BMC)
4081-341	3/4"	200 - 1000 Nm 147.6 - 738 Lb.ft	2x	110 h	156 x 110 x 80 (BMC)

Torque angle gauge
Góniometro
Goniómetro

Art.	
2037	1/2"

1/2"



Torque angle gauge with magnet arm
Góniometro con imán
Goniómetro com braço magnético

Art.	
2038.1	1/2"

1/2"



Torque angle gauge with clip arm
Góniometro con pinza
Goniómetro com braço de clip

Art.	
2038.2	1/2"

1/2"



Socket
Llave de vaso
Chave de caixa

Art.	⊙	⊙ mm	D1 mm	D2 mm	L mm
100035	1/4"	3.5	11.8	6.1	25
100040	1/4"	4	11.8	6.7	25
100045	1/4"	4.5	11.8	7.3	25
100050	1/4"	5	11.8	8.0	25
100055	1/4"	5.5	11.8	8.6	25
100060	1/4"	6	11.8	9.2	25
100070	1/4"	7	11.8	10.7	25
100080	1/4"	8	11.8	11.8	25
100090	1/4"	9	13.0	13.0	25
100100	1/4"	10	14.3	14.3	25
100110	1/4"	11	15.8	15.8	25
100120	1/4"	12	16.8	16.8	25
100130	1/4"	13	17.8	17.8	25
100140	1/4"	14	19.8	19.8	25



DIN 3124 / ISO 2725-1

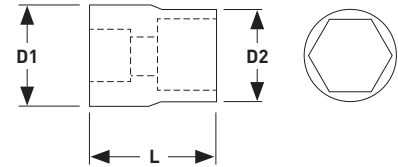

goes easy on screws and tool
protege los tornillos y el herramienta
protege parafusos e ferramentas



Inch socket
Llave de vaso pulgada
Chave de caixa polegada

Art.	⊙	⊙ inch	D1 mm	D2 mm	L mm
100503	1/4"	3/16"	11.8	7.8	25
100504	1/4"	7/32"	11.8	8.5	25
100505	1/4"	1/4"	11.8	9.5	25
100506	1/4"	9/32"	11.8	10.7	25
100507	1/4"	5/16"	11.8	11.8	25
100508	1/4"	11/32"	13.0	13.0	25
100509	1/4"	3/8"	14.2	14.2	25
100510	1/4"	7/16"	15.7	15.7	25
100511	1/4"	1/2"	17.7	17.7	25



DIN 3124 / ISO 2725-1

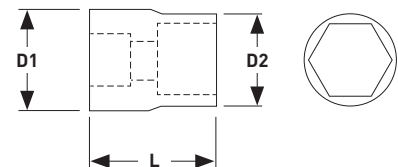

Deep socket
Llave de vaso largo
Chave de caixa longa

Art.	⊘	⊘ mm	D1 mm	D2 mm	L mm
101040	1/4"	4	11.9	6.7	50
101045	1/4"	4.5	11.9	7.5	50
101050	1/4"	5	11.9	8.0	50
101055	1/4"	5.5	11.9	8.7	50
101060	1/4"	6	11.9	9.2	50
101070	1/4"	7	11.9	10.8	50
101080	1/4"	8	11.9	11.9	50
101090	1/4"	9	13.1	13.1	50
101100	1/4"	10	14.6	14.6	50
101110	1/4"	11	15.9	15.9	50
101120	1/4"	12	16.9	16.9	50
101130	1/4"	13	17.9	17.9	50



DIN 3124 / ISO 2725-1

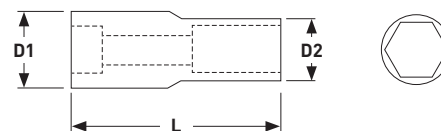

Deep inch socket
Llave de vaso largo pulgada
Chave de caixa longa polegada

Art.	⊘	⊘ inch	D1 mm	D2 mm	L mm
101503	1/4"	3/16"	11.9	7.9	50
101504	1/4"	7/32"	11.9	8.9	50
101505	1/4"	1/4"	11.9	9.9	50
101506	1/4"	9/32"	11.9	11.0	50
101507	1/4"	5/16"	11.9	11.9	50
101508	1/4"	11/32"	13.1	13.1	50
101509	1/4"	3/8"	14.6	14.6	50
101510	1/4"	7/16"	15.9	15.9	50
101511	1/4"	1/2"	17.9	17.9	50

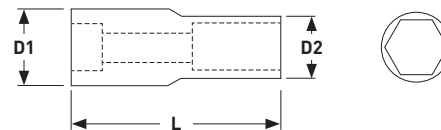

Socket COMBI

Llave de vaso COMBI

Chave de caixa COMBI

Art.	⊙	⊙ mm	⊙ inch	⊕	⊙ XZN	D1 mm	D2 mm	L mm
130040	1/4"	4	5/32"	E5	M5	11.8	6.8	25
130045	1/4"	4.5	3/16"	E6		11.8	7.3	25
130050	1/4"	5	3/16" 13/64"		M6	11.8	7.9	25
130055	1/4"	5.5	7/32"	E7		11.8	8.7	25
130060	1/4"	6	1/4"	E8	M8	11.8	9.3	25
130070	1/4"	7	9/32"			11.8	10.6	25
130080	1/4"	8	5/16"	E10	M10	11.8	12.8	25
130090	1/4"	9	11/32"			11.8	12.8	25
130100	1/4"	10	3/8"	E12	M12	13.8	15.8	25
130110	1/4"	11	7/16"	E14	M14	13.8	15.8	25
130120	1/4"	12	15/32"	E16		14.8	16.8	25
130130	1/4"	13	1/2"		M16	15.8	17.8	25
130140	1/4"	14	9/16"	E18	M18	17.8	19.8	25

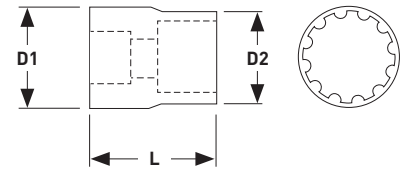
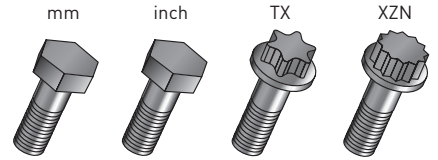

Pass through socket

enables the fastening and unfastening jobs with long bolt and threaded rods

Llave de vaso pasante

Permite la entrada en un espárrago largo para el apriete/desapriete de tuercas

Chave de caixa de aperto

permite o aperto e o desaperto de parafusos longos e de varão roscado

Art.	mm	mm	D1 mm	D2 mm	L mm
590035	13	3.5	13	5.4	25
590040	13	4	13	6.0	25
590045	13	4.5	13	6.6	25
590050	13	5	13	7.1	25
590055	13	5.5	13	8.2	25
590060	13	6	13	9.3	25
590070	13	7	13	10.0	25
590080	13	8	13	11.5	25
590090	13	9	13	12.5	25
590100	13	10	13	14.2	25
590110	13	11	13	15.3	25
590120	13	12	13	16.5	25
590130	13	13	13	17.4	25



13 mm

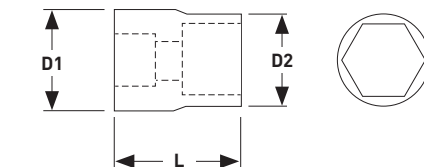

External TX-socket

Llave de vaso TX exterior

Chave de caixa TX exterior

Art.	1/4"	E	D1 mm	D2 mm	L mm
120004	1/4"	E4	11.9	7.2	25
120005	1/4"	E5	11.9	8.0	25
120006	1/4"	E6	11.9	8.0	25
120007	1/4"	E7	11.9	8.9	25
120008	1/4"	E8	11.9	10.3	25
120010	1/4"	E10	12.7	12.7	25
120011	1/4"	E11	14.1	14.1	25



1/4"

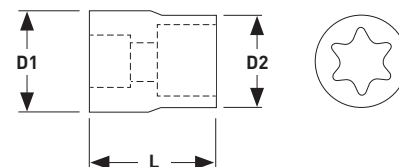

Slotted bit-socket

Llave de vaso punta ranurada

Chave de caixa com bit fenda

Art.	⊖	mm	L mm
102040	1/4"	0.5 x 4.0	38
102055	1/4"	0.8 x 5.5	38
102065	1/4"	1.0 x 6.5	38



Phillips bit-socket

Llave de vaso punta Phillips

Chave de caixa com bit Phillips

Art.	⊖	+	L mm
103001	1/4"	PH 1	38
103002	1/4"	PH 2	38
103003	1/4"	PH 3	38



Pozidriv bit-socket

Llave de vaso punta Pozidriv

Chave de caixa com bit Pozidriv

Art.	⊖	+	L mm
104000	1/4"	PZ 0	38
104001	1/4"	PZ 1	38
104002	1/4"	PZ 2	38
104003	1/4"	PZ 3	38



TX bit-socket

Llave de vaso punta TX

Chave de caixa com bit TX

Art.	⊖	★	L mm
105008	1/4"	T8	38
105010	1/4"	T10	38
105015	1/4"	T15	38
105020	1/4"	T20	38
105025	1/4"	T25	38
105027	1/4"	T27	38
105030	1/4"	T30	38
105040	1/4"	T40	38



5-star TX bit-socket

Llave de vaso punta TX 5 puntas

Chave de caixa com bit TX 5 pontas

Art.	Ø	★	L mm
115008	1/4"	TS 8	38
115009	1/4"	TS 9	38
115010	1/4"	TS 10	38
115015	1/4"	TS 15	38
115020	1/4"	TS 20	38
115025	1/4"	TS 25	38
115027	1/4"	TS 27	38
115030	1/4"	TS 30	38
115040	1/4"	TS 40	38



5-Star tamper TX bit-socket

Llave de vaso punta TX seguridad de 5 puntas

Chave de caixa com bit tamper TX 5 pontas

Art.	Ø	★	L mm
115308	1/4"	TS 8	38
115309	1/4"	TS 9	38
115310	1/4"	TS 10	38
115315	1/4"	TS 15	38
115320	1/4"	TS 20	38
115325	1/4"	TS 25	38
115327	1/4"	TS 27	38
115330	1/4"	TS 30	38
115340	1/4"	TS 40	38



Hexagonal bit-socket

Llave de vaso punta hexagonal

Chave de caixa com bit sextavada



Art.	Ø	mm	L mm
106003	1/4"	3	38
106004	1/4"	4	38
106005	1/4"	5	38
106006	1/4"	6	38
106007	1/4"	7	38
106008	1/4"	8	38



Hexagonal inch bit-socket

Llave de vaso punta hexagonal pulgada

Chave de caixa com bit sextavada polegada



Art.		 inch	L mm
106501	1/4"	1/8"	38
106502	1/4"	5/32"	38
106503	1/4"	3/16"	38
106504	1/4"	7/32"	38
106505	1/4"	1/4"	38



Extension bar

Alargadera

Extensão



Art.			L mm
107050	1/4"	1/4"	50
107100	1/4"	1/4"	100



Duplex wobble extension bar

Alargadera de punta angular duplex

Extensão com ponta angular duplex

Art.			L mm
107101	1/4"	1/4"	100
107151	1/4"	1/4"	150

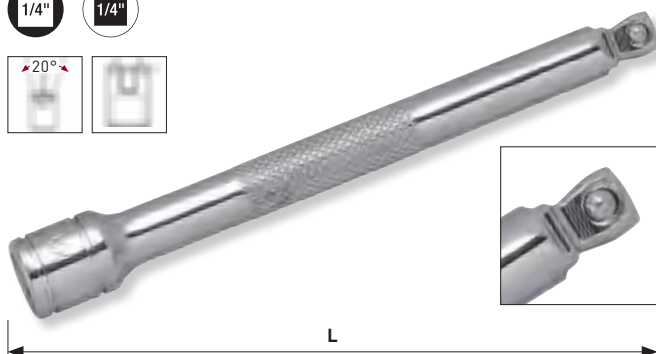
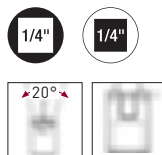

Locking extension bar

Alargadera bloqueio

Extensão com fecho

Art.			L mm
107102	1/4"	1/4"	100



Set / Juego / Jogo Art.123002
204



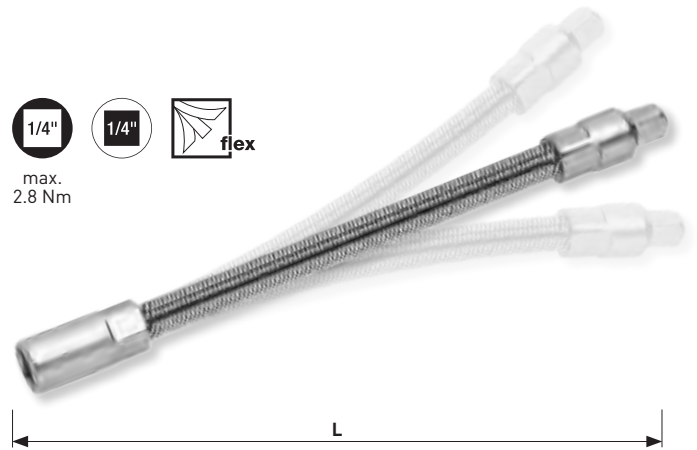

Flexible extension bar
Alargadera flexible
Extensão flexível

Art.			L mm
107155	1/4"	1/4"	146



Flexible extension bar for bits
Alargadera flexible para puntas
Extensão flexível para bits

Art.			L mm
107140	1/4"	1/4"	140

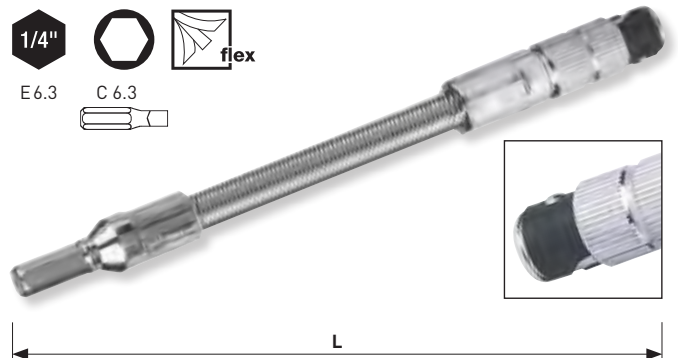

Pass through extension bar



enables the fastening and unfastening jobs with long bolt and threaded rods

Alargadera pasante

permite la entrada en un espárrago largo para el apriete/desapriete de tuercas

Extensão de aperto

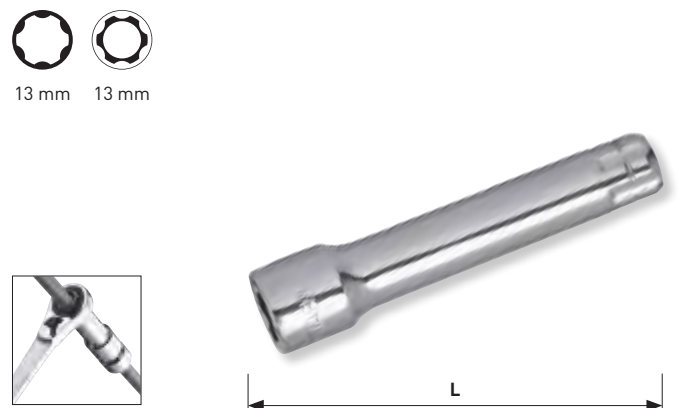

permite o aperto e o desaperto de parafusos longos e de varão roscado

Art.			L mm
597075	13	13	75

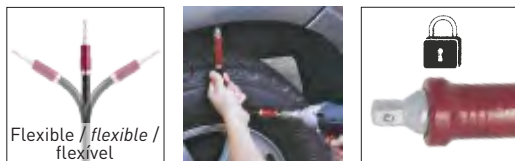

Heavy duty flexible extension socket holder
Alargadera flexible industrial para llaves de vaso
Extensão flexível de alta resistência com adaptador para chaves



Art.			L mm
107330	1/4"	1/4"	≈ 330



Heavy duty flexible extension bit holder
Alargadera flexible industrial para puntas
Extensão flexível de alta resistência com adaptador para bits

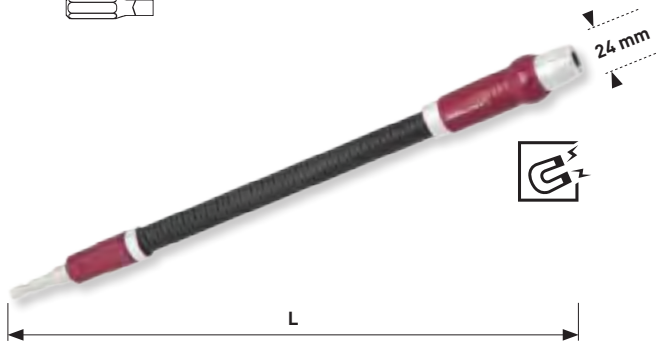
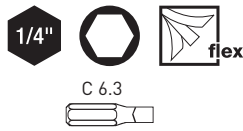
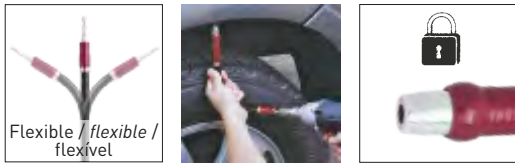

Art.			L mm
107331	1/4"	1/4"	330

Flexible socket driver handle
Vaso con mango, flexible
Chave de punho flexível



Art.	mm	L1 mm	L2 mm
109060	6	158	270
109070	7	158	270
109080	8	158	270
109090	9	158	292
109100	10	176	292
109110	11	176	292



Spinner handle
with 1/4" square drive in end of handle

Mango atornillador
con cuadrado interior 1/4" en el extremo del mango

Extensão com punho
com quadrado interior 1/4" no final pega



Art.			L1 mm	L2 mm
109150	1/4"	1/4"	70	155

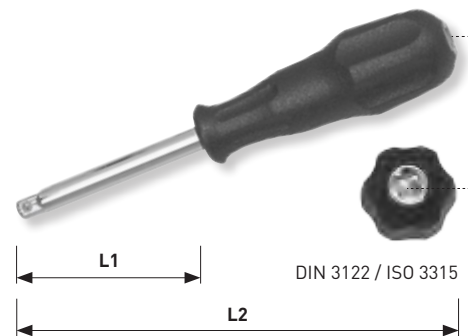

Bi-material spinner handle
with 1/4" square drive in end of handle

Mango atornillador bimaterral
con cuadrado interior 1/4" en el extremo del mango

Extensão com punho bimaterral
com quadrado interior 1/4" na extremidade do punho



Art.			L1 mm	L2 mm
109151	1/4"	1/4"	51	153



Bi-material flexible spinner handle
Mango atornillador flexible bimaterial
Chave de punho flexível bimaterial

Art.	□	L1 mm	L2 mm
109175	1/4"	158	270

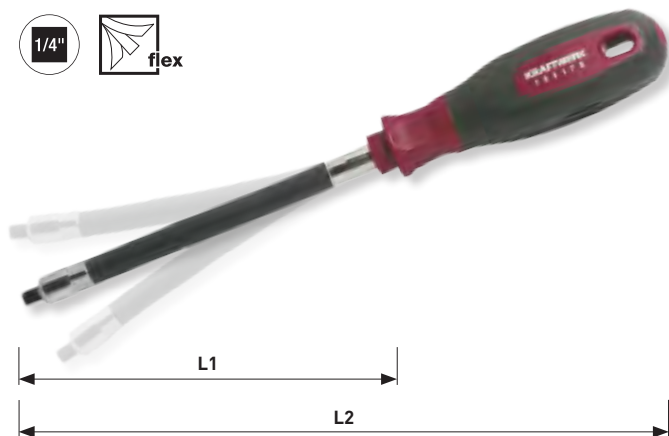

3-way t-bar-adapter
Adaptador para barra deslizante T
Adaptador de 3 vias para rabo de força

Art.	○	□	L mm
108000	1/4"	1/4"	22



Sliding t-bar
Barra deslizante T
Cabo corredeira

Art.	○	□	L mm
108100	1/4"	1/4"	105

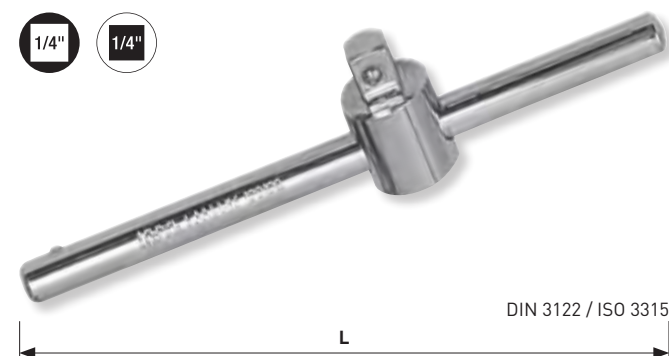

Universal joint
Articulación universal
Cardan

Art.	○	□	L mm
110000	1/4"	1/4"	35

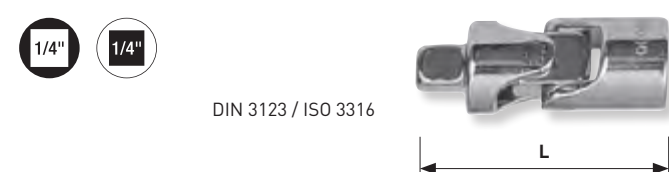

Quick locking universal joint
Articulación universal con bloqueo rápido
Cardan bloqueio com fecho rápido



Set / Juego / Jogo Art.123102
205

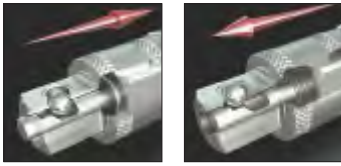

Art.			L mm
123102-14	1/4"	1/4"	55



Socket-adapter

for pass through reversible ratchet handle 590000

Adaptador llaves de vaso

para carraca reversible pasante 590000

Adaptador chaves de caixa

para roquete manual de aperto reversível 590000



13 mm

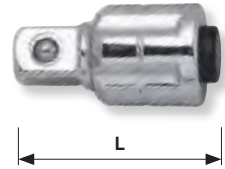

Art.	mm		L mm
591140	13	1/4"	25

Bit-adapter

for pass through reversible ratchet handle 590000

Adaptador porta punta

para carraca reversible pasante 590000

Adaptador de bit

para roquete manual de aperto reversível 590000

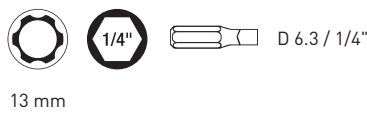

13 mm

D 6.3 / 1/4"



Art.	mm		L mm
592760	13	1/4"	22

Coupler for bits

Adaptador para puntas

Adaptador para bits

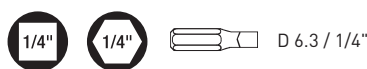

1/4"

1/4"

D 6.3 / 1/4"



Art.			L mm
2760	1/4"	1/4"	25

Socket

Llave de vaso

Chave de caixa

Art.	3/8"	mm	D1 mm	D2 mm	L mm
200060	3/8"	6	17.0	9.3	25
200070	3/8"	7	17.0	10.8	25
200080	3/8"	8	17.0	12.0	25
200090	3/8"	9	17.0	12.9	25
200100	3/8"	10	17.0	14.5	25
200110	3/8"	11	17.0	15.8	25
200120	3/8"	12	17.0	17.0	25
200130	3/8"	13	18.9	18.9	25
200140	3/8"	14	19.5	19.5	25
200150	3/8"	15	20.8	20.8	25
200160	3/8"	16	22.0	22.0	25
200170	3/8"	17	23.3	23.3	25
200180	3/8"	18	24.0	24.0	25
200190	3/8"	19	24.0	25.8	26
200200	3/8"	20	24.0	27.7	29
200210	3/8"	21	25.0	27.9	29
200220	3/8"	22	26.0	29.5	32
200240	3/8"	24	26.0	31.9	32



DIN 3124 / ISO 2725-1

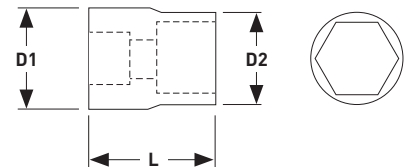

goes easy on screws and tool
protege los tornillos y el herramienta
 protege parafusos e ferramentas



Inch socket

Llave de vaso pulgada

Chave de caixa polegada

Art.	3/8"	inch	D1 mm	D2 mm	L mm
200505	3/8"	1/4"	17.2	10.0	25
200507	3/8"	5/16"	17.2	11.7	25
200509	3/8"	3/8"	17.2	13.8	25
200510	3/8"	7/16"	17.2	16.0	25
200511	3/8"	1/2"	17.9	17.9	25
200512	3/8"	9/16"	19.7	19.7	25
200513	3/8"	5/8"	22.2	22.2	25
200514	3/8"	11/16"	23.9	23.9	25
200515	3/8"	3/4"	25.9	25.9	25
200516	3/8"	13/16"	27.9	27.9	29
200517	3/8"	7/8"	29.7	29.7	29
200518	3/8"	15/16"	31.9	31.9	29
200519	3/8"	1"	33.9	33.9	29

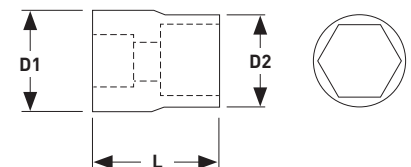

Deep socket
Llave de vaso largo
Chave de caixa longa

Art.	⊘	⊘ mm	D1 mm	D2 mm	L mm
201080	3/8"	8	16.8	12.0	64
201100	3/8"	10	16.8	14.4	64
201110	3/8"	11	16.8	15.9	64
201120	3/8"	12	16.8	16.8	64
201130	3/8"	13	18.8	18.8	64
201140	3/8"	14	19.8	19.8	64
201150	3/8"	15	20.4	20.4	64
201170	3/8"	17	23.8	23.8	64
201180	3/8"	18	23.8	23.8	64
201190	3/8"	19	26.0	26.0	64
201220	3/8"	22	29.5	29.5	64



DIN 3124 / ISO 2725-1

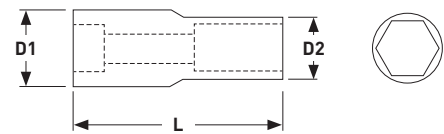

Spark plug socket
Llave de vaso bujías
Chave de caixa velas

Art.	⊘	⊘ mm	D mm	L mm
201114	3/8"	14	18	64
201160	3/8"	16	22	64
201118	3/8"	18	23.8	64
201210	3/8"	21	27.3	64



AUTOMOTIVE

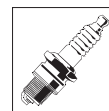

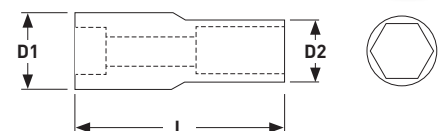

Deep inch socket
Llave de vaso largo pulgada
Chave de caixa longa polegada

Art.	⊘	⊘ inch	D1 mm	D2 mm	L mm
201509	3/8"	3/8"	16.8	14.4	64
201510	3/8"	7/16"	16.8	16.0	64
201511	3/8"	1/2"	17.8	17.8	64
201512	3/8"	9/16"	19.8	19.8	64
201514	3/8"	11/16"	23.8	23.8	64
201515	3/8"	3/4"	25.8	25.8	64
201517	3/8"	7/8"	29.8	29.8	64



Inch spark plug socket
Llave de vaso bujías pulgada
Chave de caixa velas polegada

Art.		 inch	D mm	L mm
201513	3/8"	5/8"	22.0	64
201516	3/8"	13/16"	27.2	70

Pass through socket



enables the fastening and unfastening jobs with long bolt and threaded rods.

Llave de vaso pasante

permite la entrada en un espárrago largo para el apriete/desapriete de tuercas.

Chave de caixa de aperto



permite o aperto e o desaperto de parafusos longos e de varão roscado.

Art.	 mm	 mm	D1 mm	D2 mm	L mm
600100	20	10	20	14.6	32
600110	20	11	20	15.3	32
600120	20	12	20	16.6	32
600130	20	13	20	17.7	32
600140	20	14	20	18.8	32
600150	20	15	20	20.0	32
600160	20	16	20	21.2	32
600170	20	17	20	22.5	32
600180	20	18	20	23.6	32
600190	20	19	20	24.4	32

External TX-socket

Llave de vaso TX exterior

Chave de caixa TX exterior

Art.			D1 mm	D2 mm	L mm
220004	3/8"	E4	16.8	7.1	26
220005	3/8"	E5	16.8	8.0	26
220006	3/8"	E6	16.8	8.0	26
220007	3/8"	E7	16.8	9.0	26
220008	3/8"	E8	16.8	10.5	26
220010	3/8"	E10	16.8	13.0	26
220011	3/8"	E11	16.8	14.0	26
220012	3/8"	E12	16.8	15.5	26
220014	3/8"	E14	18.9	18.9	28
220016	3/8"	E16	18.9	18.9	28
220018	3/8"	E18	19.8	19.8	28
220020	3/8"	E20	21.8	21.8	30



AUTOMOTIVE

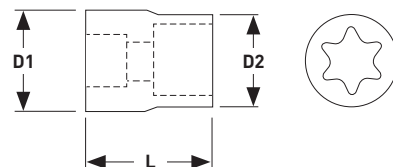
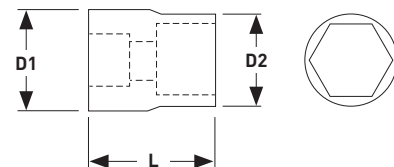
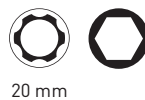
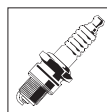

Slotted bit-socket

Llave de vaso punta ranurada

Chave de caixa com bit fenda

Art.	Ø	mm	L mm
202055	3/8"	0.8 x 5.5	48
202065	3/8"	1.0 x 6.5	48
202080	3/8"	1.6 x 8.0	48



Phillips bit-socket

Llave de vaso punta Phillips

Chave de caixa com bit Phillips

Art.	Ø	+	L mm
203001	3/8"	PH 1	48
203002	3/8"	PH 2	48
203003	3/8"	PH 3	48



Pozidriv bit-socket

Llave de vaso punta Pozidriv

Chave de caixa com bit Pozidriv

Art.	Ø	+	L mm
204001	3/8"	PZ 1	48
204002	3/8"	PZ 2	48
204003	3/8"	PZ 3	48



TX bit-socket

Llave de vaso punta TX

Chave de caixa com bit TX

Art.	Ø	★	L mm
205010	3/8"	T10	48
205015	3/8"	T15	48
205020	3/8"	T20	48
205025	3/8"	T25	48
205027	3/8"	T27	48
205030	3/8"	T30	48
205040	3/8"	T40	48
205045	3/8"	T45	48
205050	3/8"	T50	48
205055	3/8"	T55	48
205060	3/8"	T60	48



Tamper TX bit-socket

Llave de vaso punta TX seguridad

Chave de caixa com bit tamper TX

Art.	Ø	☆	L mm
205310	3/8"	T10	48
205315	3/8"	T15	48
205320	3/8"	T20	48
205325	3/8"	T25	48
205327	3/8"	T27	48
205330	3/8"	T30	48
205340	3/8"	T40	48
205345	3/8"	T45	48
205350	3/8"	T50	48
205355	3/8"	T55	48
205360	3/8"	T60	48

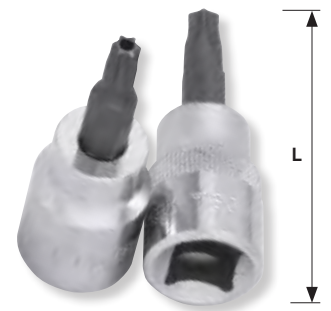

Hexagonal bit-socket

Llave de vaso punta hexagonal

Chave de caixa com bit sextavada

Art.	Ø	● mm	L mm
206003	3/8"	3	48
206004	3/8"	4	48
206005	3/8"	5	48
206006	3/8"	6	48
206007	3/8"	7	48
206008	3/8"	8	48
206010	3/8"	10	48



Hexagonal inch bit-socket

Llave de vaso punta hexagonal pulgada

Chave de caixa com bit sextavada polegada

Art.	Ø	● inch	L mm
206501	3/8"	1/8"	48
206502	3/8"	5/32"	48
206503	3/8"	3/16"	48
206504	3/8"	7/32"	48
206505	3/8"	1/4"	48
206507	3/8"	5/16"	48
206509	3/8"	3/8"	48



Extension bar
Alargadera
Extensão

Art.	○	■	L mm
207075	3/8"	3/8"	75
207150	3/8"	3/8"	150
207250	3/8"	3/8"	250



Duplex wobble extension bar
Alargadera de punta angular duplex
Extensão com ponta angular duplex

Art.	○	■	L mm
207076	3/8"	3/8"	75
207151	3/8"	3/8"	150
207251	3/8"	3/8"	250



Locking extension bar
Alargadera bloqueo
Extensão com fecho

Art.	○	■	L mm
207152	3/8"	3/8"	150
207252	3/8"	3/8"	250



Set / Juego / Jogo

Art.123002
204

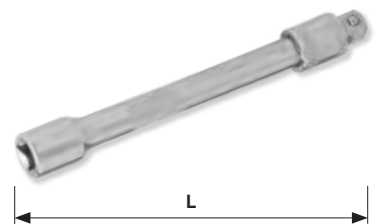

Pass through extension bar

enables the fastening and unfastening jobs with long bolt and threaded rods.

Alargadera pasante

permite la entrada en un espárrago largo para el apriete/ desapriete de tuercas.



Extensão de aperto

permite o aperto e o desaperto de parafusos longos e de varão roscado.

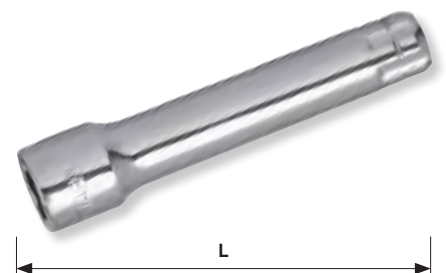
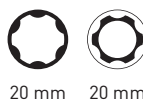
Art.	○ mm	○ mm	L mm
607075	20	20	75



3-way t-bar-adapter
Adaptador para barra deslizante T
Adaptador de 3 vias para rabo de força

Art.			L mm
208000	1/2"	3/8"	22



Locking t-bar
Barra T con bloqueo
Extensão em T com fecho

Art.		L mm
212650	3/8"	650

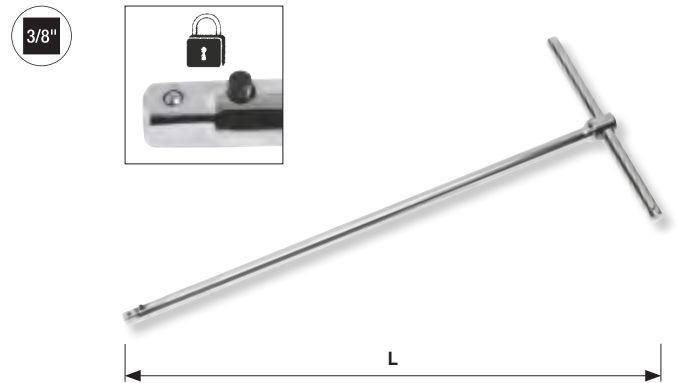

Universal joint
Articulación universal
Cardan

Art.			L mm
210000	3/8"	3/8"	50

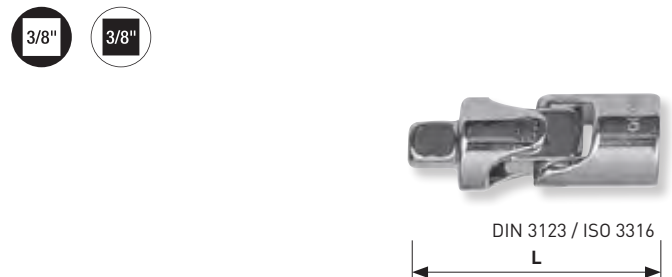

Quick locking universal joint
Articulación universal con bloqueo rápido
Cardan bloqueio com fecho rápido





Art.			L mm
123102-38	3/8"	3/8"	79



Socket adapter

Adaptador reductor para llaves de vaso

Adaptador reductor para chaves de caixa

Art.			L mm
213814	3/8"	1/4"	26



DIN 3123 / ISO 3316



Socket-adapter



for pass through reversible ratchet handle 600000

Adaptador llaves de vaso

para carraca reversible pasante 600000

Adaptador chaves de caixa

para roquete manual de aperto reversível 600000

Art.			L mm
611140	20 mm	1/4"	28
611380	20 mm	3/8"	28



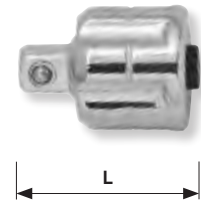

20 mm



Coupler for bits

Adaptador para puntas

Adaptador para bits



Art.			L mm
2761	3/8"	1/4"	25



Coupler for bits

Adaptador para puntas

Adaptador para bits

Art.			L mm
211516	3/8"	5/16"	29



Socket
Llave de vaso
Chave de caixa

Art.	⊘	⊘ mm	D1 mm	D2 mm	L mm
300080	1/2"	8	22.2	13.3	38
300100	1/2"	10	22.2	15.3	38
300110	1/2"	11	22.2	16.5	38
300120	1/2"	12	22.2	17.8	38
300130	1/2"	13	22.2	19.0	38
300140	1/2"	14	22.2	20.3	38
300150	1/2"	15	22.2	21.8	38
300160	1/2"	16	22.2	22.2	38
300170	1/2"	17	23.9	23.9	38
300180	1/2"	18	24.9	24.9	38
300190	1/2"	19	24.1	25.9	38
300200	1/2"	20	24.1	27.8	38
300210	1/2"	21	24.3	27.9	38
300220	1/2"	22	26.5	29.9	38
300240	1/2"	24	26.5	31.9	38
300270	1/2"	27	29.3	35.9	40
300300	1/2"	30	33.4	39.9	43
300320	1/2"	32	34.4	41.9	43
300340	1/2"	34	35.2	43.8	43



DIN 3124 / ISO 2725-1

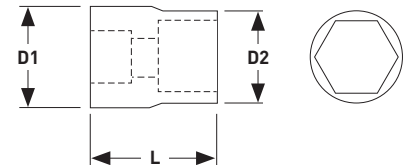

goes easy on screws and tool
protege los tornillos y el herramienta
protege parafusos e ferramentas



Deep socket
Llave de vaso largo
Chave de caixa longa

Art.	⊘	⊘ mm	D1 mm	D2 mm	L mm
301100	1/2"	10	22.0	15.3	77
301110	1/2"	11	22.0	16.5	77
301116	1/2"	16	22.0	22.0	77
301120	1/2"	12	22.0	17.8	77
301130	1/2"	13	22.0	19.0	77
301140	1/2"	14	22.0	20.3	77
301150	1/2"	15	22.0	22.0	77
301170	1/2"	17	23.8	23.8	77
301180	1/2"	18	25.8	25.8	77
301190	1/2"	19	25.8	25.8	77
301220	1/2"	22	29.8	29.8	77



DIN 3124 / ISO 2725-1

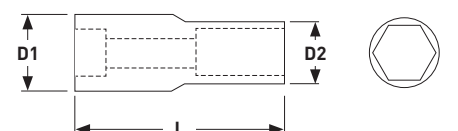

Spark plug socket
Llave de vaso bujías
Chave de caixa velas



Art.	⊖	⊖ mm	D mm	L mm
301160	1/2"	16	22.8	64.0
301210	1/2"	21	27.8	70.0

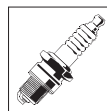

AUTOMOTIVE



Socket COMBI
Llave de vaso COMBI
Chave de caixa COMBI



Art.	⊖	⊖ mm	⊖ inch	⊕	⊕ XZN	D1 mm	D2 mm	L mm
330100	1/2"	10	3/8"	E12	M12	21.7	15.5	38
330110	1/2"	11	7/16"	E14	M14	21.7	16.5	38
330120	1/2"	12	15/32"	E16		21.7	17.7	38
330130	1/2"	13	1/2"		M16	21.7	19.0	38
330140	1/2"	14	9/16"	E18	M18	21.9	19.9	38
330150	1/2"	15	19/32"			20.9	21.8	38
330160	1/2"	16	5/8"	E20		21.8	23.8	38
330170	1/2"	17				21.8	23.8	38
330180	1/2"	18		E22		23.9	25.6	38
330190	1/2"	19	3/4"	E24		23.9	25.8	38
330200	1/2"	20	25/32"			26.0	27.8	38
330210	1/2"	21				26.0	29.0	38
330220	1/2"	22	7/8"			26.0	30.0	38
330240	1/2"	24	15/16"			28.0	32.0	38
330270	1/2"	27	1 1/16"			30.8	35.6	42
330300	1/2"	30	1 1/8"			33.8	39.7	44
330320	1/2"	32	1 1/4"			36.0	41.8	44

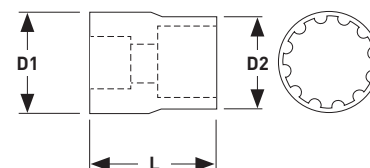
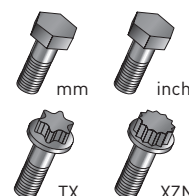

Impact socket
Llave de vaso de impacto
Chave de caixa impacto



Art.	□	○ mm	L mm
380080	1/2"	8	38
380090	1/2"	9	38
380100	1/2"	10	38
380110	1/2"	11	38
380120	1/2"	12	38
380130	1/2"	13	38
380140	1/2"	14	38
380150	1/2"	15	38
380160	1/2"	16	38
380170	1/2"	17	38
380180	1/2"	18	38
380190	1/2"	19	38
380200	1/2"	20	38
380210	1/2"	21	38
380220	1/2"	22	38
380230	1/2"	23	38
380240	1/2"	24	38
380270	1/2"	27	38
380300	1/2"	30	38
380320	1/2"	32	38

DIN 3129 / ISO 2725-2



Deep impact socket

Llave de vaso largo de impacto

Chave de caixa impacto longa

Art.	⊘	⊘ mm	L mm
381080	1/2"	8	78
381090	1/2"	9	78
381100	1/2"	10	78
381110	1/2"	11	78
381120	1/2"	12	78
381130	1/2"	13	78
381140	1/2"	14	78
381150	1/2"	15	78
381160	1/2"	16	78
381170	1/2"	17	78
381180	1/2"	18	78
381190	1/2"	19	78
381200	1/2"	20	78
381210	1/2"	21	78
381220	1/2"	22	78
381230	1/2"	23	78
381240	1/2"	24	78
381270	1/2"	27	78
381300	1/2"	30	78
381320	1/2"	32	78



DIN 3129 / ISO 2725-2

Deep impact socket

with plastic insert to protect the wheel nuts and plastic sleeve for aluminium rims.

Llave de vaso largo de impacto

con plástico para proteger las tuercas de rueda y recubrimiento plástico para llantas en aluminio.

Chave de caixa impacto longa

com protecção plástica para proteger as porcas das rodas e manga plástica para as jantes de alumínio.

Art.	⊘	⊘ mm	colour	L mm
381150-0	1/2"	15		85
381170-0	1/2"	17		85
381190-0	1/2"	19		85
381210-0	1/2"	21		85
381220-0	1/2"	22		85
381240-0	1/2"	24		85



AUTOMOTIVE



DIN 3129 / ISO 2725-2

Pass through socket

enables the fastening and unfastening jobs with long bolt and threaded rods.

Llave de vaso pasante

permite la entrada en un espárrago largo para el apriete/ desapriete de tuercas.

Chave de caixa de aperto

permite o aperto e o desaperto de parafusos longos e de varão roscado.

Art.	mm	mm	D1 mm	D2 mm	L mm
610190	30	19	30	24.8	42
610200	30	20	30	26.0	42
610210	30	21	30	27.0	42
610220	30	22	30	28.0	42
610240	30	24	30	31.8	42
610270	30	27	30	35.8	42
610300	30	30	30	39.8	45
610320	30	32	30	41.8	48
610340	30	34	30	43.8	50

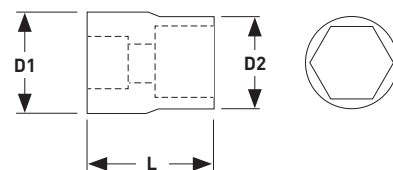
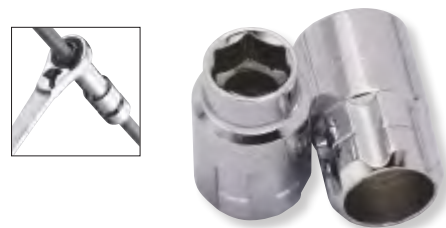

External TX-socket

Llave de vaso TX exterior

Chave de caixa TX exterior

Art.	mm	mm	D1 mm	D2 mm	L mm
320010	1/2"	E10	22	13	38
320012	1/2"	E12	22	15	38
320014	1/2"	E14	22	17	38
320016	1/2"	E16	22	19	38
320018	1/2"	E18	24	21	38
320020	1/2"	E20	26	23.5	38
320022	1/2"	E22	26	26	38
320024	1/2"	E24	28	28	40

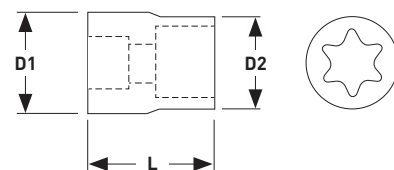

TX bit-socket

Llave de vaso punta TX

Chave de caixa com bit TX

Art.	Ø	★	L mm
325010	1/2"	T10	56
325015	1/2"	T15	56
325020	1/2"	T20	56
325025	1/2"	T25	56
325027	1/2"	T27	56
325030	1/2"	T30	56
325040	1/2"	T40	56
325045	1/2"	T45	56
325050	1/2"	T50	56
325055	1/2"	T55	56
325060	1/2"	T60	56
325070	1/2"	T70	56

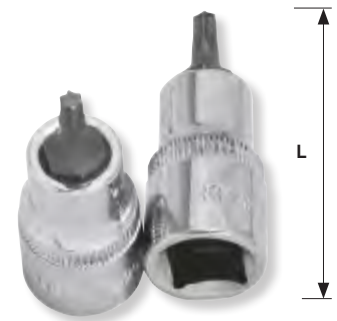

Long TX bit-socket

Llave de vaso largo, punta TX

Chave de caixa com bit TX longa

Art.	Ø	★	L mm
335010	1/2"	T10	100
335015	1/2"	T15	100
335020	1/2"	T20	100
335025	1/2"	T25	100
335027	1/2"	T27	100
335030	1/2"	T30	100
335040	1/2"	T40	100
335045	1/2"	T45	100
335050	1/2"	T50	100
335055	1/2"	T55	100
335060	1/2"	T60	100



Long taper TX bit-socket

Llave de vaso largo, punta TX seguridad

Chave de caixa com bit taper TX longa

Art.	Ø	☆	L mm
345330	1/2"	T30	200
345340	1/2"	T40	200
345345	1/2"	T45	200
335370	1/2"	T70	100
325380	1/2"	T80	200
325381	1/2"	T80	70



TX impact socket

Llave de vaso de impacto, TX

Chave de caixa impacto TX

Art.	Ø	☆	L mm
385010	1/2"	T10	78
385015	1/2"	T15	78
385020	1/2"	T20	78
385025	1/2"	T25	78
385027	1/2"	T27	78
385030	1/2"	T30	78
385040	1/2"	T40	78
385045	1/2"	T45	78
385050	1/2"	T50	78
385055	1/2"	T55	78
385060	1/2"	T60	78
385070	1/2"	T70	78
385080	1/2"	T80	78
385090	1/2"	T90	78



Hexagonal bit-socket

Llave de vaso punta hexagonal

Chave de caixa com bit sextavado

Art.	⊙	● mm	L mm
326005	1/2"	5	55
326006	1/2"	6	55
326007	1/2"	7	55
326008	1/2"	8	55
326010	1/2"	10	55
326012	1/2"	12	55
326014	1/2"	14	55
326017	1/2"	17	55



Long hexagonal bit-socket

Llave de vaso largo, punta hexagonal

Chave de caixa com bit sextavada longa

Art.	⊙	● mm	L mm
336005	1/2"	5	100
336006	1/2"	6	100
336007	1/2"	7	100
336008	1/2"	8	100
336010	1/2"	10	100
336012	1/2"	12	100



Hexagonal impact socket

Llave de vaso de impacto, hexagonal

Chave de caixa impacto sextavada

Art.	⊙	● mm	L mm
386003	1/2"	3	78
386004	1/2"	4	78
386005	1/2"	5	78
386006	1/2"	6	78
386007	1/2"	7	78
386008	1/2"	8	78
386009	1/2"	9	78
386010	1/2"	10	78
386012	1/2"	12	78
386014	1/2"	14	78
386016	1/2"	16	78
386017	1/2"	17	78



Spline bit-socket

Llave de vaso punta XZN

Chave de caixa com bit XZN

Art.	Ø	XZN	L mm
328005	1/2"	M5	55
328006	1/2"	M6	55
328008	1/2"	M8	55
328010	1/2"	M10	55
328012	1/2"	M12	55
328014	1/2"	M14	55
328016	1/2"	M16	55

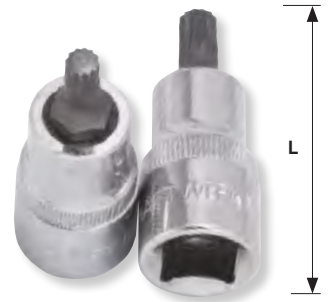

Long spline bit-socket

Llave de vaso largo, punta XZN

Chave de caixa com bit XZN longa

Art.	Ø	XZN	L mm
338005	1/2"	M5	100
338006	1/2"	M6	100
338008	1/2"	M8	100
338010	1/2"	M10	100
338012	1/2"	M12	100



XZN-Spline impact socket

Llave de vaso de impacto, XZN

Chave de caixa impacto XZN

Art.	Ø	XZN	L mm
388004	1/2"	M4	78
388005	1/2"	M5	78
388006	1/2"	M6	78
388008	1/2"	M8	78
388009	1/2"	M9	78
388010	1/2"	M10	78
388012	1/2"	M12	78
388014	1/2"	M14	78
388016	1/2"	M16	78
388018	1/2"	M18	78



Tamper RIBE bit-socket

Llave de vaso punta RIBE seguridad

Chave de caixa com bit tamper RIBE



Art.	Ø	⚙️	L mm
329005	1/2"	RM5	55
329006	1/2"	RM6	55
329007	1/2"	RM7	55
329008	1/2"	RM8	55
329009	1/2"	RM9	55
329010	1/2"	RM10	55
329011	1/2"	RM11	55
329012	1/2"	RM12	55
329013	1/2"	RM13	55
329014	1/2"	RM14	55



Long tamper RIBE bit-socket

Llave de vaso largo, punta RIBE seguridad

Chave de caixa com bit tamper RIBE longa



Art.	Ø	⚙️	L mm
339005	1/2"	RM5	100
339006	1/2"	RM6	100
339007	1/2"	RM7	100
339008	1/2"	RM8	100
339009	1/2"	RM9	100
339010	1/2"	RM10	100
339011	1/2"	RM11	100
339012	1/2"	RM12	100
339013	1/2"	RM13	100
339014	1/2"	RM14	100



RIBE impact socket

Llave de vaso de impacto, RIBE

Chave de caixa impacto RIBE



Art.	□	⚙	L mm
389004	1/2"	RM4	78
389005	1/2"	RM5	78
389006	1/2"	RM6	78
389007	1/2"	RM7	78
389008	1/2"	RM8	78
389009	1/2"	RM9	78
389010	1/2"	RM10	78
389012	1/2"	RM12	78
389013	1/2"	RM13	78
389014	1/2"	RM14	78



Extension bar

Alargadera

Extensão

Art.	□	■	L mm
307125	1/2"	1/2"	125
307250	1/2"	1/2"	250



Duplex wobble extension bar

Alargadera de punta angular duplex

Extensão com ponta angular duplex

Art.	□	■	L mm
307126	1/2"	1/2"	125
307251	1/2"	1/2"	250

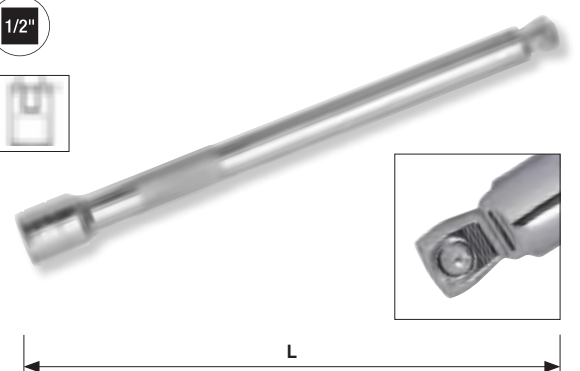
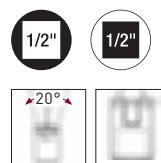

Locking extension bar
Alargadera bloqueo
Extensão com fecho

Art.	○	■	L mm
307127	1/2"	1/2"	125
307252	1/2"	1/2"	250

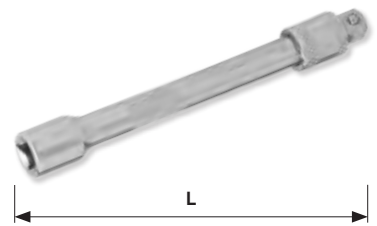
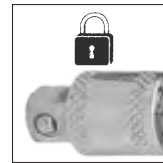

Quick locking extension bar set
Juego de alargaderas con extracción rápida
Jogo de extensões de fecho segurança

Art.	○	■	L mm
123002	1/4"	1/4"	100
	3/8"	3/8"	150
	1/2"	1/2"	250



Pass through extension bar

enables the fastening and unfastening jobs with long bolt and threaded rods.

Alargadera pasante

permite la entrada en un espárrago largo para el apriete/ desapriete de tuercas.

Extensão de aperto

permite o aperto e o desaperto de parafusos longos e de varão roscado.

Art.	○	⊗ mm	L mm
617075	30	30	75
617150	30	30	150



30 mm

30 mm

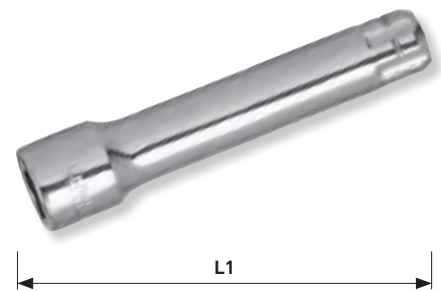

Impact extension bar
Alargadera impacto
Extensão de impacto



Art.	○	■	L mm
387125	1/2"	1/2"	125



3-way t-bar-adapter

Adaptador para barra deslizante T

Adaptador de 3 vias para rabo de força

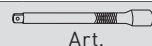

Art.			 Art.	L mm
308000	3/8"	1/2"	307250	43.5
308001	3/8"	1/2"	307251	43.5



Universal joint

Articulación universal

Cardan

Art.			L mm
310000	1/2"	1/2"	75



DIN 3123 / ISO 3316



Quick locking universal joint

Articulación universal con bloqueo rápido

Cardan bloqueio com fecho rápido

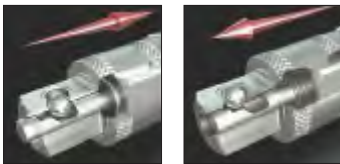

Art.			L mm
123102-12	1/2"	1/2"	79





Quick locking universal joint set

Juego de articulaciones con cierre y extracción rápida de vaso

Jogo de cardan bloqueio com fecho rápido



Art.			L mm
123102	1/4"	1/4"	55
	3/8"	3/8"	79
	1/2"	1/2"	110

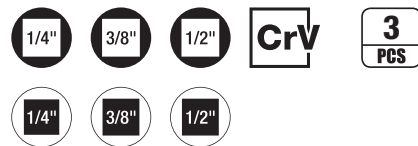

Impact universal joint
Articulación universal impacto
Cardan de impacto

Art.	○	■	L mm
381000	1/2"	1/2"	65



DIN 3123 / ISO 3316

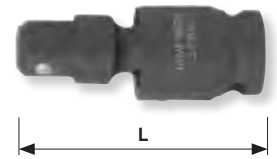

Wobble impact universal joint set
Juego de articulaciones universales impacto
Jogo de cardans de impacto

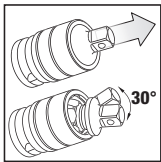

Art.	○	■	L mm
387998	1/4"	1/4"	37
	3/8"	3/8"	46
	1/2"	1/2"	62

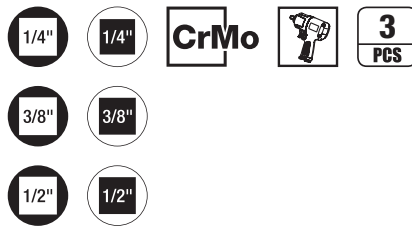

Wobble impact adaptor set
Juego de adaptadores/reductores articulados de impacto
Jogo de adaptadores/redutores de impacto

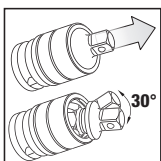

Art.	○	■	L mm
387999	1/4"	3/8"	36
	3/8"	1/4"	44
	3/8"	1/2"	48
	1/2"	3/8"	57
	1/2"	3/4"	70

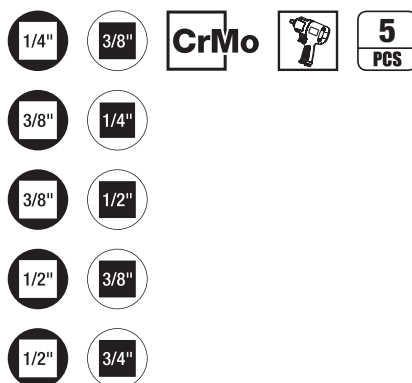

Socket adapter
Adaptador
Adaptador

Art.	○	■	L mm
311340	1/2"	3/4"	46



DIN 3123 / ISO 3316



Socket reducer
Reductor
Redutor

Art.	○	■	L mm
311380	1/2"	3/8"	37



DIN 3123 / ISO 3316



Impact socket adapter
Adaptador impacto
Adaptador de impacto

Art.	○	■	L mm
381340	1/2"	3/4"	48



DIN 3121 / ISO 1174



Coupler for bits
Acoplador puntas
Adaptador de bits

Art.	○	○	L mm
311516	1/2"	5/16"	38



Impact coupler for bits
Acoplador impacto puntas
Adaptador de impacto para bits

Art.	○	○	L mm
381516	1/2"	5/16"	39



DIN 7427-A



Socket adapter

for pass through reversible ratchet handle 610000

Adaptador llaves de vaso

para carraca reversible pasante 610000

Adaptador chaves de caixa

para roquete manual de aperto reversível 610000



Art.			L mm
611120	1/2"	30 mm	40

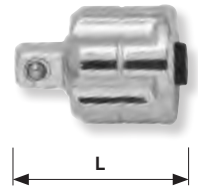

Impact socket adapter

with locking function

Adaptador impacto para llaves de vaso

con bloqueo

Adaptador de impacto para chaves de caixa

com fecho automático

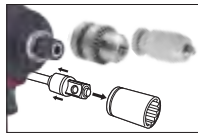
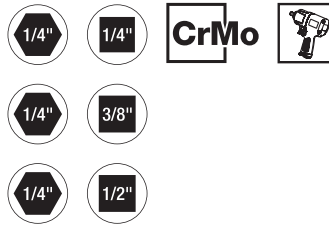

Art.			L mm
381014	1/4"	1/4"	75
381038	1/4"	3/8"	75
381012	1/4"	1/2"	75
381003	1/4"	Set / Carraca / Roquete 1/4" + 3/8" + 1/2"	75

3
PCS



Impact socket adapter

with locking function

Adaptador impacto para llaves de vaso

con bloqueo

Adaptador de impacto para chaves de caixa

com fecho automático

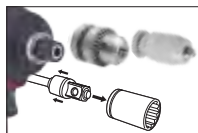
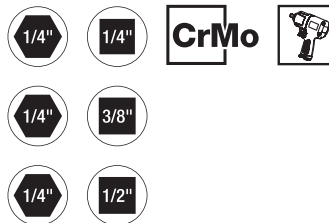

Art.			L mm
381114	1/4"	1/4"	150
381138	1/4"	3/8"	150
381112	1/4"	1/2"	150
381103	1/4"	Set / Carraca / Roquete 1/4" + 3/8" + 1/2"	150

3
PCS



Socket adapter set

with specially slim profile

Juego adaptadores para vasos

con perfil especialmente fino

Conjunto de adaptadores de caixa

com perfil especialmente fino

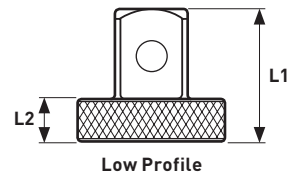

Art.	⊘	■	L1 mm	L2 mm
123003	1/4"	3/8"	18	6.5
	3/8"	1/2"	23	7.5
	1/2"	3/4"	34.5	11.5

Socket

Llave de vaso

Chave de caixa



DIN 3124 / ISO 2725-1

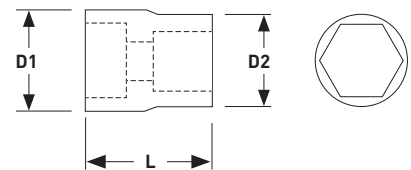

Art.	⊘	⊘ mm	D1 mm	D2 mm	L mm
400190	3/4"	19	33.0	29.0	50
400210	3/4"	21	33.0	31.0	50
400220	3/4"	22	36.0	32.0	50
400230	3/4"	23	36.0	33.0	50
400240	3/4"	24	36.0	34.0	51
400260	3/4"	26	38.0	36.0	52
400270	3/4"	27	36.0	38.0	52
400290	3/4"	29	38.0	40.0	52
400300	3/4"	30	38.0	42.0	54
400320	3/4"	32	38.0	44.0	56
400350	3/4"	35	42.0	48.0	58
400360	3/4"	36	42.0	50.0	58
400380	3/4"	38	45.0	52.0	60
400410	3/4"	41	45.0	56.0	64
400460	3/4"	46	47.0	62.0	68
400500	3/4"	50	48.0	68.0	72

Impact socket

Llave de vaso impacto

Chave de caixa impacto



Art.	⊙	⊙ mm	L mm
480170	3/4"	17	50
480190	3/4"	19	52
480200	3/4"	20	52
480210	3/4"	21	52
480220	3/4"	22	52
480230	3/4"	23	52
480240	3/4"	24	52
480250	3/4"	25	52
480260	3/4"	26	52
480270	3/4"	27	52
480280	3/4"	28	52
480290	3/4"	29	52
480300	3/4"	30	52
480320	3/4"	32	52
480330	3/4"	33	56
480340	3/4"	34	56
480350	3/4"	35	56
480360	3/4"	36	56
480380	3/4"	38	56
480410	3/4"	41	58
480460	3/4"	46	63
480500	3/4"	50	72



Deep impact socket

Llave de vaso largo de impacto

Chave de caixa impacto longa



Art.	⌀	⌀ mm	L mm
481170	3/4"	17	90
481180	3/4"	18	90
481190	3/4"	19	90
481210	3/4"	21	90
481220	3/4"	22	90
481240	3/4"	24	90
481260	3/4"	26	90
481270	3/4"	27	90
481290	3/4"	29	90
481300	3/4"	30	90
481320	3/4"	32	90
481350	3/4"	35	90
481360	3/4"	36	90
481380	3/4"	38	92
481410	3/4"	41	92
481460	3/4"	46	92
481500	3/4"	50	95



Extension bar
Alargadera
Extensão

Art.	○	■	L mm
407100	3/4"	3/4"	100
407200	3/4"	3/4"	200
407400	3/4"	3/4"	400

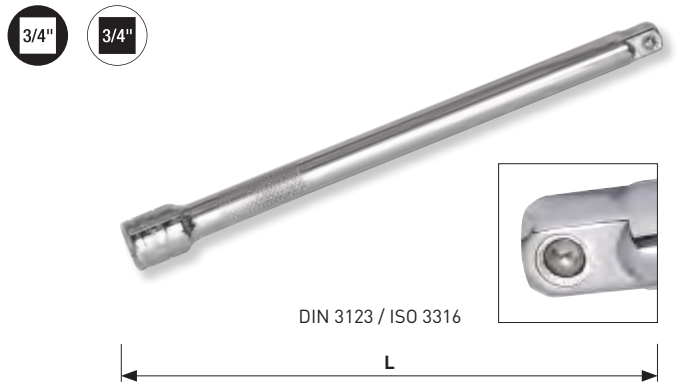

Locking extension bar
Alargadera bloqueio
Extensão com fecho

Art.	○	■	L mm
407102	3/4"	3/4"	100
407202	3/4"	3/4"	200
407402	3/4"	3/4"	400

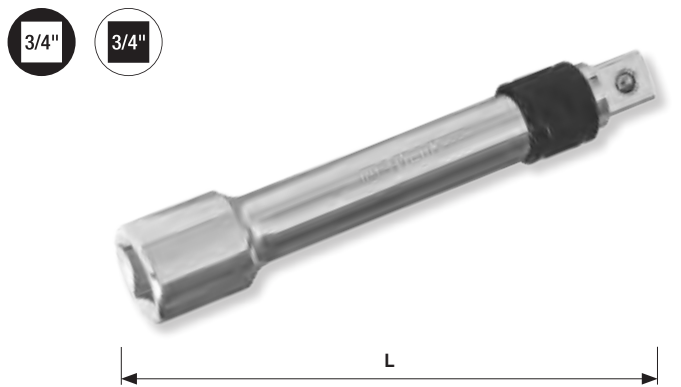

Impact extension bar
Alargadera impacto
Extensão de impacto

Art.	○	■	L mm
487100	3/4"	3/4"	100
487200	3/4"	3/4"	200



Sliding t-bar
Barra T deslizante
Cabo T corredeira

Art.	■	L mm
408000	3/4"	460

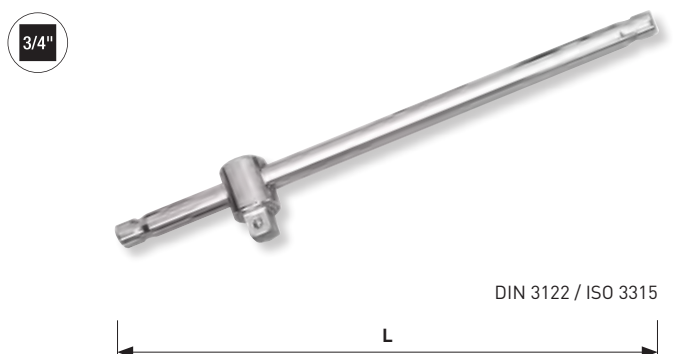

Locking sliding t-bar
Barra T deslizante bloqueo
Cabo T corrediço com fecho

Art.		L mm
408002	3/4"	460

3/4"

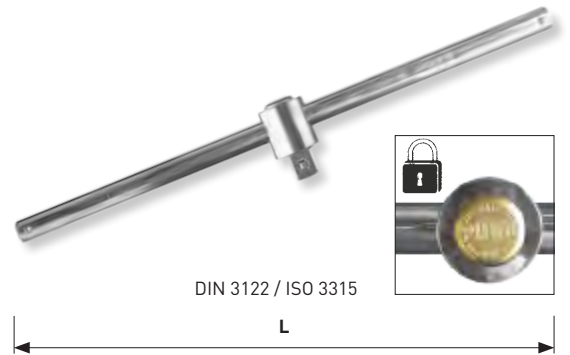

Impact universal joint
Articulación universal impacto
Cardan de impacto

Art.			L mm
481000	3/4"	3/4"	90



3/4"

3/4"

CrMo



Socket adapter
Adaptador
Adaptador

Art.			L mm
411120	3/4"	1"	56

3/4"

1"



DIN 3123 / ISO 3316

Socket reducer
Reductor
Redutor

Art.			L mm
411100	3/4"	1/2"	56



3/4"

1/2"



DIN 3123 / ISO 3316

Impact socket adapter
Adaptador impacto
Adaptador de impacto

Art.			L mm
483410	3/4"	1"	64

3/4"

1"

CrMo



Impact socket reducer
Reductor impacto
Redutor de impacto

Art.	○	■	L mm
483412	3/4"	1/2"	56



Socket
Llave de vaso
Chave de caixa

Art.	○	○ mm	D1 mm	D2 mm	L mm
500360	1"	36	45	51	65
500380	1"	38	45	54	65
500410	1"	41	45	57	70
500460	1"	46	50	65	75
500500	1"	50	55	70	75
500540	1"	54	57	74	80
500550	1"	55	57	76	80
500580	1"	58	57	79	80
500600	1"	60	57	82	84
500630	1"	63	57	86	87
500650	1"	65	57	88	87
500670	1"	67	57	90	90
500700	1"	70	68	94	93
500710	1"	71	68	95	93
500750	1"	75	68	100	97
500770	1"	77	68	102	103
500800	1"	80	68	105	103



DIN 3124 / ISO 2725-1

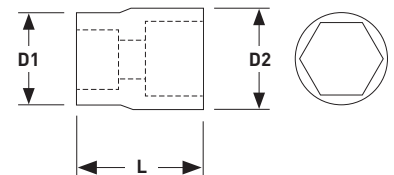

Deep impact socket

Llave de vaso largo de impacto

Chave de caixa impacto longa



Art.	1"	mm	L mm
581220	1"	22	90
581240	1"	24	90
581270	1"	27	90
581300	1"	30	90
581320	1"	32	90
581330	1"	33	90
581340	1"	34	90
581360	1"	36	90
581380	1"	38	92
581410	1"	41	92
581460	1"	46	92
581500	1"	50	95
581550	1"	55	100
581600	1"	60	105
581650	1"	65	120
581700	1"	70	124
581750	1"	75	135
581800	1"	80	135
581850	1"	85	140
581900	1"	90	140



Extension bar
Alargadera
Extensão

Art.	○	■	L mm
507200	1"	1"	200
507400	1"	1"	400

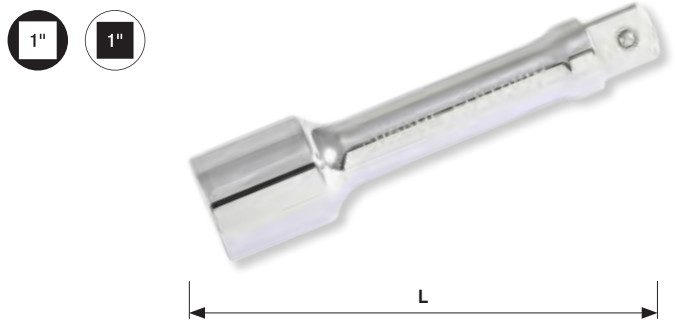

Impact extension bar
Alargadera impacto
Extensão de impacto

Art.	○	■	L mm
587200	1"	1"	200



3-way t-bar-adapter
Adaptador para barra deslizante T
Adaptador de 3 vias para rabo de força

Art.	○	■	L mm
508000	1"	1"	74



Impact universal joint
Articulación universal impacto
Cardan de impacto

Art.	○	■	L mm
581000	1"	1"	110

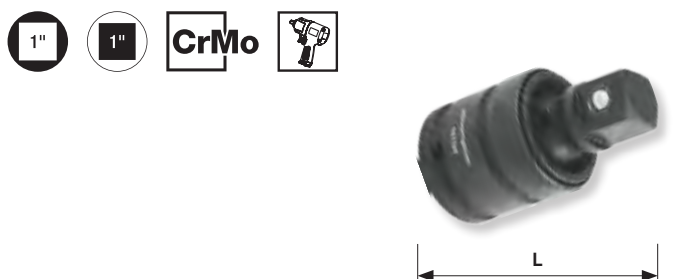

Socket reducer
Reductor
Redutor

Art.	○	■	L mm
511340	1"	3/4"	70



DIN 3123 / ISO 3316

Impact socket reducer
Reductor impacto
Redutor de impacto

Art.	○	■	L mm
581034	1"	3/4"	75









75
19 mm
3/4"

72

60
8-9 mm
3/16-5/16"

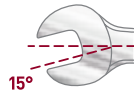
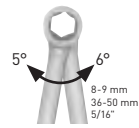

CLICKRAFT

DOUBLE RATCHET

COMBINATION

XXL LARGO

XXL LARGO 90

DOUBLE RING

REVERSIBLE

QUAD REVERSIBLE

FLEX

STUBBY FLEX

DOUBLE FLEX

ANGLE

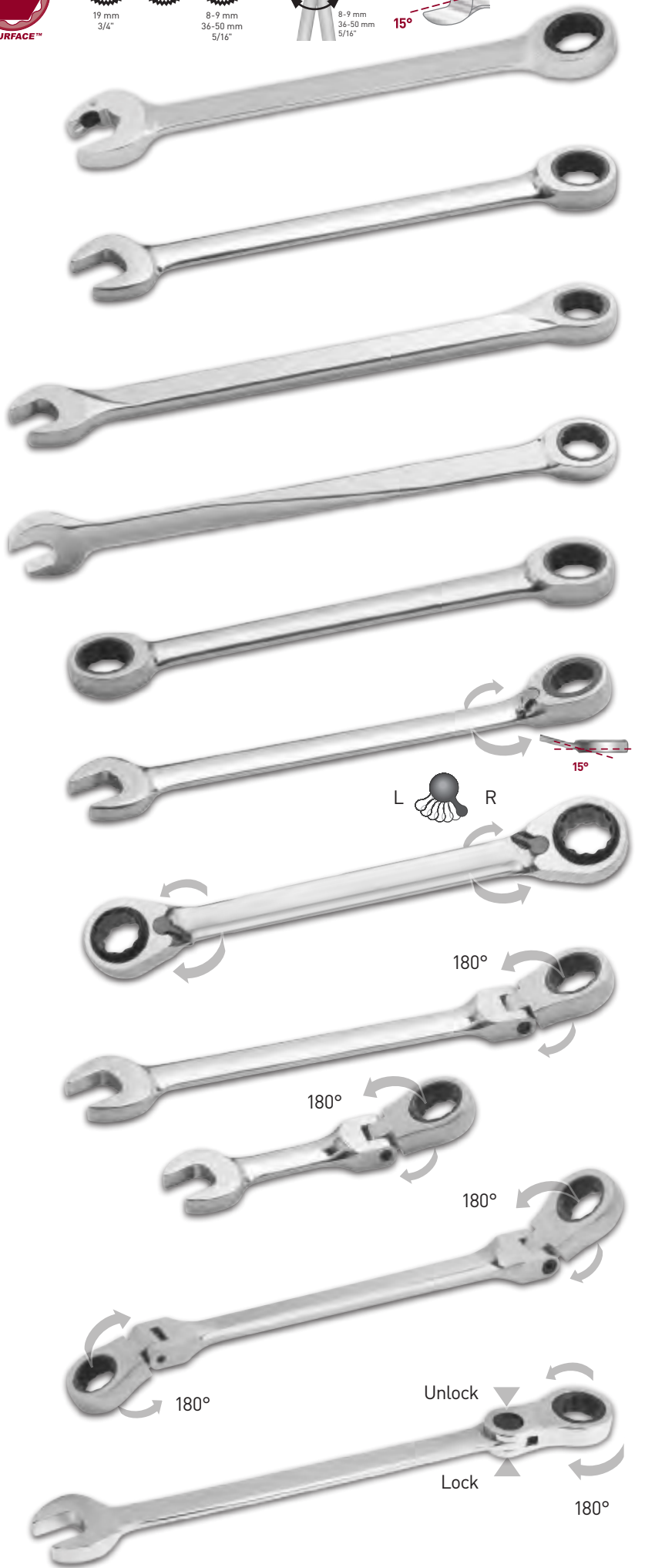

DOUBLE RATCHET CLICKRAFT

Double ratchet combination wrench

flat, with additional ratcheting function in the open end

Llave combinada doble carraca

plana, con mecanismo adicional efecto carraca en la boca abierta

Chave boca-luneta com roquete duplo

direita, com mecanismo de roquete adicional na boca

Art.	Ø mm	D mm	L mm	Ø
3401-08	8	17.7	140	60
3401-09	9	19.0	149	60
3401-10	10	21.1	159	72
3401-11	11	23.1	165	72
3401-12	12	24.5	172	72
3401-13	13	26.5	178	72
3401-14	14	27.9	190	72
3401-15	15	30.5	199	72
3401-16	16	32.4	208	72
3401-17	17	34.2	225	72
3401-18	18	35.3	236	72
3401-19	19	36.1	248	75
3401-20	20	42.3	270	72
3401-21	21	42.3	270	72
3401-22	22	42.3	291	72
3401-24	24	49.3	312	72

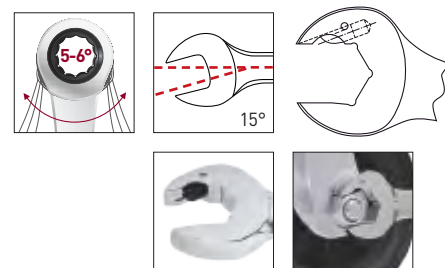
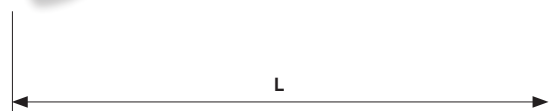

Double ratchet combination wrench set

flat, with additional ratcheting function in the open end

Juego de llaves combinadas doble carraca

planas, con mecanismo adicional efecto carraca en la boca abierta

Jogo de chaves boca-luneta com roquete duplo

direitas, com mecanismo de roquete adicional na boca

4
PCS



Art.	Ø mm
3401-50	10-13-17-19

Double ratchet combination wrench set

flat, with additional ratcheting function in the open end

Juego de llaves combinadas doble carraca

planas, con mecanismo adicional efecto carraca en la boca abierta

Jogo de chaves boca-luneta com roquete duplo

direitas, com mecanismo de roquete adicional na boca

Art.	mm
3401-54	8-9-10-11-12-13-14-15-16-17-18-19



Double ratchet combination wrench case

flat, with additional ratcheting function in the open end (except 5.5-6-7 mm)









Estuche de llaves combinadas doble carraca

planas, con mecanismo adicional efecto carraca en la boca abierta (excepto 5.5-6-7 mm)

Jogo de chaves boca-luneta com roquete duplo em mala

direitas, com mecanismo de roquete adicional na boca (exceto 5.5-6-7 mm)

*Option / Opcionales / Opção

- Art. 3691  1/4" x  10 mm
- Art. 3692  3/8" x  13 mm
- Art. 3693  1/2" x  19 mm
- Art. 2694  1/4" x  10 mm



Art.	mm
4900-40K	5.5-6-7-8-9-10-11-12-13-14-15-16-17-18-19



COMBINATION CLICKRAFT

Ratchet combination wrench

flat

Llave combinada carraca

plana

Chave boca-luneta com roquete

direita

Art.	mm	D mm	L mm	mm
3405	5.5	16.5	125	60
3406	6	17.0	125	60
3407	7	17.0	140	60
3408	8	17.0	140	60
3409	9	18.5	149	60
3410	10	20.5	160	72
3411	11	21.5	165	72
3412	12	23.0	170	72
3413	13	25.0	180	72
3414	14	28.0	190	72
3415	15	29.0	200	72
3416	16	30.0	210	72
3417	17	31.5	225	72
3418	18	33.0	235	72
3419	19	34.0	250	75
3420	20	41.0	290	72
3421	21	41.0	290	72
3422	22	41.5	290	72
3424	24	48.0	333	72
3427M	27	52.5	360	72
3430M	30	59.0	400	72
3432M	32	62.5	425	72
3434M	34	63.0	460	72
3436M	36	64.0	500	60
3441M	41	68.0	575	60
3446M	46	76.0	645	60
3450M	50	80.0	655	60

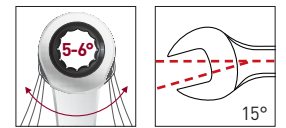
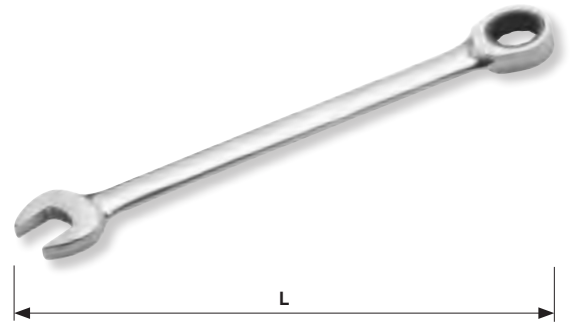

Ratchet combination wrench set

flat

Juego de llaves combinadas carraca

planas

Jogo de chaves boca-luneta com roquete

direitas

Art.	mm
3400-50	10-13-17-19

4
PCS



Ratchet combination wrench set

flat

Juego de llaves combinadas carraca

planas

Jogo de chaves boca-luneta com roquete

direitas

Art.	mm
3427	8-10-12-13-17-19

6
PCS



Ratchet combination wrench case

flat

Juego de llaves combinadas carraca

planas

Jogo de chaves boca-luneta com roquete

direitas

Art.	mm
3400-54	8-9-10-11-12-13-14-15-16-17-18-19

12
PCS



↕ 325 x 185 x 56 mm

COMBINATION CLICKRAFT

COMPLETO

19
PCS



421 x 200 x 68 mm

Ratchet combination wrench case

flat, with socket- and bit-adapters

Estuche de llaves combinadas carraca

planas, con adaptadores para llaves de vaso y puntas

Jogo de chaves boca-luneta com roquete em mala

direitas, com adaptadores para chaves de caixa e bits

* inklusiv / inclus / incluso



Art. 3691 1/4" x 10 mm

Art. 3692 3/8" x 13 mm

Art. 3693 1/2" x 19 mm



Art. 2694 1/4" x 10 mm



Art.	mm
4900-17K	5.5-6-7-8-9-10-11-12-13-14-15-16-17-18-19

Ratchet combination wrench, inch

flat

Llave combinada carraca pulgada

plana

Chave boca-luneta com roquete, polegada

direita

inch

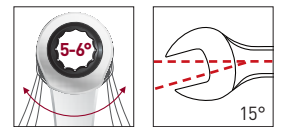
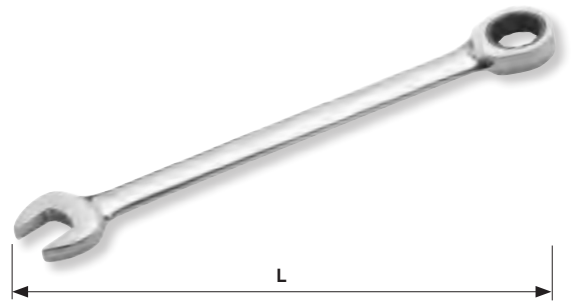

Art.	inch	D mm	L mm	mm
3431	5/16"	17.0	140	60
3432	3/8"	20.5	160	72
3433	7/16"	21.2	165	72
3434	1/2"	25.5	180	72
3435	9/16"	28.0	190	72
3436	5/8"	30.0	210	72
3437	11/16"	31.5	225	72
3438	3/4"	34.0	250	75

Ratchet combination wrench set, inch

flat

Juego de llaves combinadas carraca en pulgadas

planas

Jogo de chaves boca-luneta com roquete, polegada

direitas

8
PCS

inch



Art.	inch
3430	5/16"-3/8"-7/16"-1/2"-9/16"-5/8"-11/16"-3/4"

Ratchet combination wrench

flat, extra long

Llave combinada carraca

plana, extra larga

Chave boca-luneta com roquete

direita, extra longa



Art.	○ mm	D mm	L mm	○
4402-08	8	17.5	150	60
4402-09	9	18.3	165	60
4402-11	11	22.3	195	72
4402-12	12	24.0	207	72
4402-14	14	28.2	235	72
4402-15	15	30.2	250	72
4402-16	16	32.0	260	72
4402-17	17	32.8	275	72
4402-18	18	33.6	290	72
4402-19	19	36.4	305	75
4402-20	20	41.2	318	72
4402-21	21	41.2	318	72
4402-22	22	41.2	330	72
4402-24	24	46.7	356	72

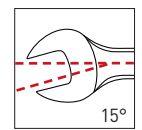
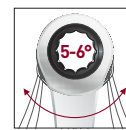

LARGO



STANDARD

LARGO

+22%

STANDARD



XXL

Ratchet combination wrench set

flat, extra long

Juego de llaves combinadas carraca

planas, extra largas

Jogo de chaves boca-luneta com roquete

direitas, extra longas

*Option / Opcionales / Opção



Art. 3691 1/4" x 10 mm

Art. 3692 3/8" x 13 mm

Art. 3693 1/2" x 19 mm



Art. 2694 1/4" x 10 mm



Art.	mm
4402-51	8-10-13-17-19

5
PCS



Ratchet combination wrench set

flat, extra long

Juego de llaves combinadas carraca

planas, extra largas

Jogo de chaves boca-luneta com roquete

direitas, extra longas

*Option / Opcionales / Opção



Art. 3691 1/4" x 10 mm

Art. 3692 3/8" x 13 mm

Art. 3693 1/2" x 19 mm



Art. 2694 1/4" x 10 mm



Art.	mm
4402-52	8-10-11-12-13-16-17-18-19

9
PCS



Ratchet combination wrench set

flat, extra long

Juego de llaves combinadas carraca

planas, extra largas

Jogo de chaves boca-luneta com roquete

direitas, extra longas

*Option / Opcionales / Opção



Art. 3691 1/4" x 10 mm

Art. 3692 3/8" x 13 mm

Art. 3693 1/2" x 19 mm



Art. 2694 1/4" x 10 mm



Art.	mm
4402-53	8-9-10-11-12-13-14-15-16-17-18-19

12
PCS



LARGO 90 combination ratchet wrench

500 % more contact and press area grace to the 90° crossbeam forge of the LARGO 90-wrench. Open and ring end sided working without tender spots in your hands since you work with the handle surface and not with the thin handle edge.

Llave combinada con carraca LARGO 90

500 % de mayor contacto y area de presión gracias a su torsión a 90° de la nueva serie LARGO. La presión se realiza sobre una superficie plana en vez de sobre los bordes rectos de la llave permitiendo trabajar con una máxima ergonomía para la palma de la mano.

Chave boca-luneta com roquete LARGO 90

500 % mais área de contacto e força graças aos 90° da nova chave LARGO 90. A pressão exercida na parte plana e não na parte lateral mais fina que permite um trabalhar em perfeita ergonomia com a mão.

Art.	mm	D mm	L mm	mm
4405-08	8	17.5	148	60
4405-09	9	18.3	163	60
4405-10	10	21.3	179	72
4405-11	11	22.3	193	72
4405-12	12	24.0	204	72
4405-13	13	26.3	219	72
4405-14	14	28.2	234	72
4405-15	15	30.2	248	72
4405-16	16	32.0	259	72
4405-17	17	32.8	274	72
4405-18	18	33.6	291	72
4405-19	19	36.4	305	75

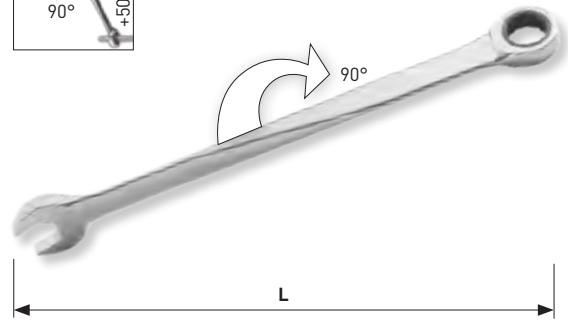
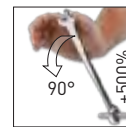

LARGO 90 combination ratchet wrench case

500 % more contact and press area grace to the 90° crossbeam forge of the wrench

Estuche de llaves combinadas con carraca LARGO 90

500 % de mayor contacto y área de presión gracias a su torsión a 90° de la llave

Jogo de chaves boca-luneta com roquete LARGO 90 em mala

500 % mais area de contacto e força graças aos 90° da nova chave

Art.	mm
4900-28K	8-9-10-11-12-13-14-15-16-17-18-19

12
PCS

COMPLETO

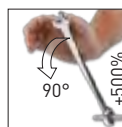

421 x 200 x 68 mm

DOUBLE RING CLICKRAFT

Double ring ratchet wrench

flat

Llave poligonal doble con carraca

plana

Chave luneta dupla com roquete

direita

Art.	○ mm	L mm	○
3441	8 x 9	130	60
3440	8 x 10	128	60 x 72
3442	10 x 11	150	72
3447	10 x 13	160	72
3443	12 x 13	170	72
3444	14 x 15	187	72
3445	16 x 18	210	72
3446	17 x 19	230	72 x 75

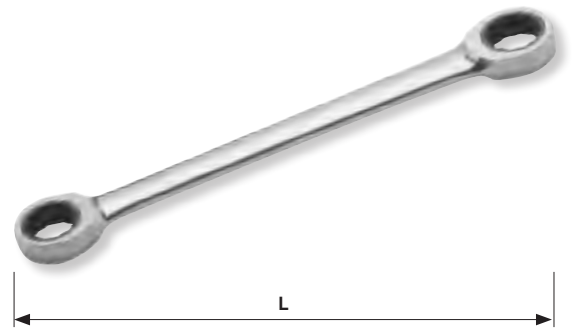

External TX double ring ratchet wrench

flat

Llave de estrella doble con carraca TX exterior

plana

Chave luneta com roquete TX exterior

direita

Art.	⊛	L mm	○
3471	E6 x E8	130	60
3472	E10 x E12	150	60
3473	E14 x E18	190	60
3474	E20 x E24	230	60

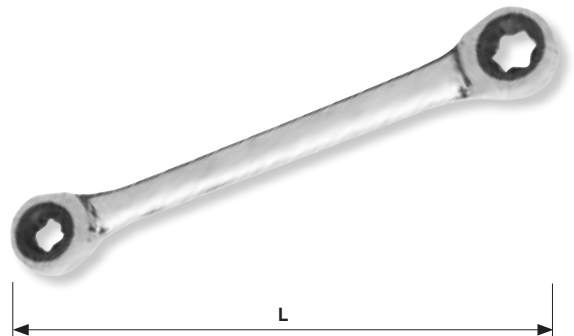

Ratchet combination wrench

reversible

Llave combinada con carraca

reversible

Chave boca-luneta com roquete

reversível

Art.	Ø mm	D mm	L mm	Ø
3404-08	8	16.8	140	60
3404-09	9	18.2	149	60
3404-10	10	20.1	159	72
3404-11	11	21.5	165	72
3404-12	12	23.0	170	72
3404-13	13	25.1	180	72
3404-14	14	27.1	190	72
3404-15	15	29.0	200	72
3404-16	16	30.6	208	72
3404-17	17	31.8	225	72
3404-18	18	32.3	236	72
3404-19	19	34.1	248	75
3404-20	20	41.7	290	72
3404-21	21	41.7	290	72
3404-22	22	41.7	290	72
3404-24	24	48.0	330	72

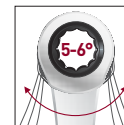
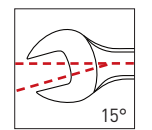
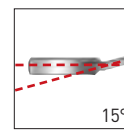
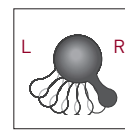

REVERSIBLE CLICKRAFT

Ratchet combination wrench set

reversible

Juego de llaves combinadas con carraca

reversibles

Jogo de chaves boca-luneta com roquete

reversíveis

4
PCS



Art.	mm
3404-50	10-13-17-19

Ratchet combination wrench set

reversible

Juego de llaves combinadas con carraca

reversibles

Jogo de chaves boca-luneta com roquete

reversíveis

6
PCS



Art.	mm
3404-51	8-10-12-13-17-19

Ratchet combination wrench set

reversible

Juego de llaves combinadas con carraca

reversibles

Jogo de chaves boca-luneta com roquete

reversíveis

12
PCS



↕ 325 x 185 x 56 mm

Art.	mm
3404-54	8-9-10-11-12-13-14-15-16-17-18-19

Ratchet combination wrench case

reversible

Estuche de llaves combinadas con carraca

reversibles

Jogo de chaves boca-luneta com roquete em mala

reversíveis

Art.	○ mm
4900-47K	8-9-10-11-12-13-14-15-16-17-18-19-22-24

4-in-1 double ring ratchet wrench

reversible

Llave poligonal doble con carraca 4-en-1

reversible

Chave luneta dupla com roquete 4-em-1

reversíveis

Art.	○ mm	L mm	○
3404-0813	8 x 10 mm 12 x 13 mm	160	72 x 72
3404-1019	10 x 13 mm 17 x 19 mm	200	72 x 75
3404-1619	16 x 17 mm 18 x 19 mm	230	72 x 75
3404-51612	5/16" x 3/8" 7/16" x 1/2"	160	72 x 72
3404-91634	9/16" x 5/8" 11/16" x 3/4"	210	72 x 75

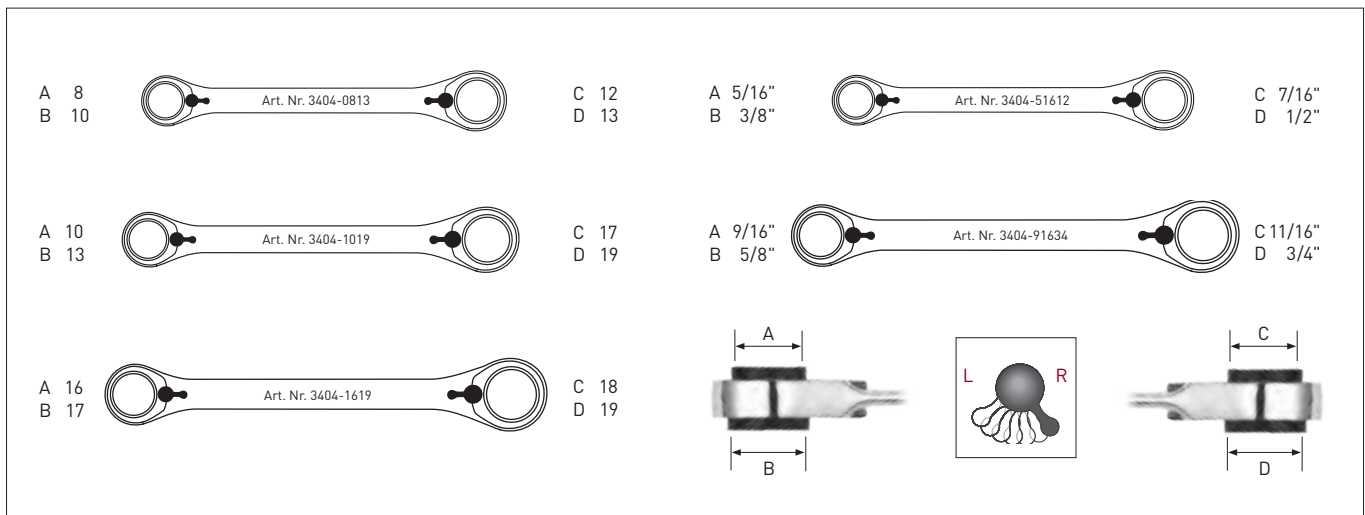

14
PCS



COMPLETO



421 x 200 x 68 mm

QUAD REVERSIBLE CLICKRAFT



4in1



QUAD REVERSIBLE CLICKRAFT

4-in-1 double ring ratchet wrench set

reversible

Juego de llaves poligonales doble con carraca

4-en-1

reversibles

Jogo de chaves luneta dupla com roquete

4-em-1

reversíveis

2
PCS



250 x 110 x 35 mm

Art.	mm
3404-4x2	8 x 10 / 12 x 13 16 x 17 / 18 x 19

Ratchet combination wrench

flexible

Llave combinada con carraca

flexible

Chave boca-luneta com roquete

flexível

Art.	mm	D mm	L mm	mm
3403-08	8	17.0	140	60
3403-09	9	19.0	149	60
3403-10	10	20.0	158	72
3403-11	11	22.0	165	72
3403-12	12	23.0	171	72
3403-13	13	25.0	176	72
3403-14	14	27.5	190	72
3403-15	15	29.0	199	72
3403-16	16	30.0	208	72
3403-17	17	32.0	225	72
3403-18	18	34.0	236	72
3403-19	19	34.3	248	75
3403-20	20	42.0	290	72
3403-21	21	42.0	290	72
3403-22	22	42.0	290	72
3403-24	24	49.0	333	72

FLEX CLICKRAFT

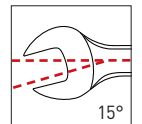
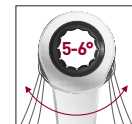
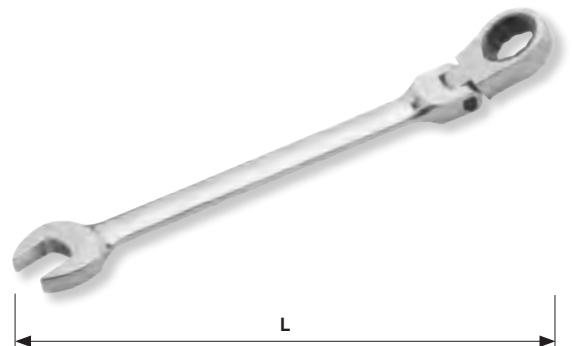

Ratchet combination wrench set

flexible

Juego de llaves combinadas con carraca

flexibles

Jogo de chaves boca-luneta com roquete

flexíveis

Art.	mm
3403-51	8-10-12-13-17-19

6
PCS



Ratchet combination wrench set

flexible

Juego de llaves combinadas con carraca

flexibles

Jogo de chaves boca-luneta com roquete

flexíveis

Art.	mm
3403-54	8-9-10-11-12-13-14-15-16-17-18-19

12
PCS



↕ 325 x 185 x 56 mm

Ratchet combination wrench case

flexible

Estuche de llaves combinadas con carraca

flexibles

Jogo de chaves boca-luneta com roquete em mala

flexíveis

Art.	mm
4900-46K	8-9-10-11-12-13-14-15-16-17-18-19-22-24

14
PCS



COMPLETO



↕ 421 x 200 x 68 mm

STUBBY FLEX CLICKRAFT

Ratchet combination wrench

flexible, Stubby

Llave combinada con carraca

flexible, corta

Chave boca-luneta com roquete

flexível, curta

Art.	mm	D mm	L mm	mm
3403-08S	8	17.0	88	60
3403-10S	10	20.0	94	72
3403-11S	11	22.0	102	72
3403-12S	12	23.0	105	72
3403-13S	13	25.0	107	72
3403-14S	14	27.5	114	72

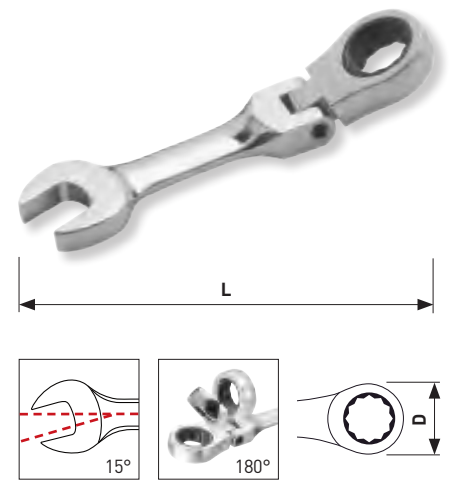

Ratchet combination wrench

swivelling laterally stepless up to 180° for ratcheting even at badly accessible places. Locking knob for fixation of the angle

Llave combinada con carraca

oscilante lateralmente sin escalonamiento hasta 180° para trabajar en sitios de muy difícil acceso. Botón de bloqueo para fijar el ángulo

Chave boca-luneta com roquete

angular sem escala até 180° lateral para trabalhar em sítios de acesso limitado. Sistema de bloqueio para o ângulo

Art.	mm	D mm	L mm	mm
3402-08	8	17.0	151	60
3402-09	9	17.9	164	60
3402-10	10	19.8	179	72
3402-11	11	21.6	194	72
3402-12	12	23.0	205	72
3402-13	13	24.7	219	72
3402-14	14	26.3	233	72
3402-15	15	28.4	247	72
3402-16	16	30.5	257	72
3402-17	17	31.8	272	72
3402-18	18	33.2	287	72
3402-19	19	34.0	303	75

ANGLE CLICKRAFT

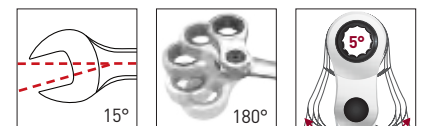
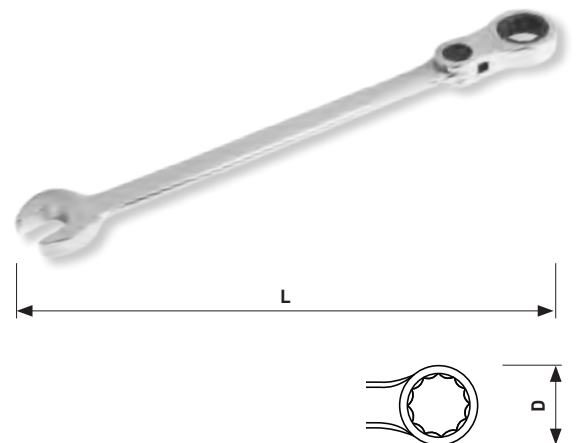

Ratchet combination wrench case

swivelling laterally stepless up to 180° for ratcheting even at badly accessible places. Locking knob for fixation of the angle

Estuche de llaves combinadas con carraca

oscilantes lateralmente sin escalonamiento hasta 180° para trabajar en sitios de muy difícil acceso. Botón de bloqueo para fijar el ángulo

Jogo de chaves boca-luneta com roquete em mala

angular e sem escala até 180° lateral para trabalhar em sítios de acesso limitado. Sistema de bloqueio para o ângulo

*Option / Opcionales / Opção



Art.	mm
4900-41K	8-9-10-11-12-13-14-15-16-17-18-19

Socket- and bit-adapter set

Juego de adaptador para llaves de vaso y portapuntas

Jogo de adaptadores para chaves de caixa e bits

Art.	mm	+	D mm
3691	10	1/4" + 1/4"	20

Socket adapter

Adaptador para llaves de vaso

Adaptador para chaves de caixa

Art.	mm		D mm
3692	13	3/8"	25

Socket adapter

Adaptador para llaves de vaso

Adaptador para chaves de caixa

Art.	mm		D mm
3693	19	1/2"	35

12
PCS



COMPLETO



421 x 200 x 68 mm

CLICKRAFT

1/4"

1/4"

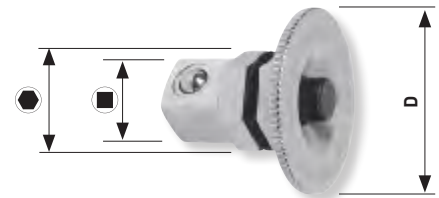

3/8"

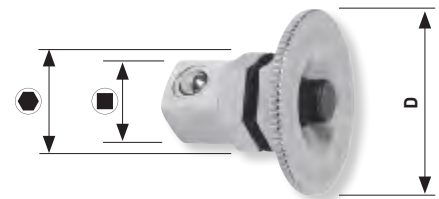

1/2"

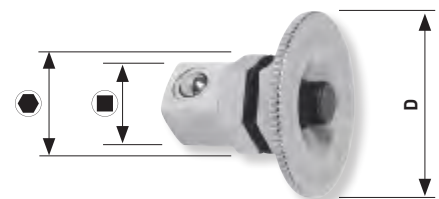

Combination wrench

mirror polished

Llave combinada

pulido brillante

Chave de boca-luneta

polida

Art.	Ø mm	L mm
3505	5.5	127
3506	6	127
3507	7	134
3508	8	140
3509	9	150
3510	10	159
3511	11	165
3512	12	172
3513	13	179
3514	14	191
3515	15	199
3516	16	206
3517	17	225
3518	18	235
3519	19	248
3520	20	272
3521	21	272
3522	22	291
3523	23	315
3524	24	315
3525	25	335
3526	26	335
3527	27	358
3528	28	402
3530	30	425
3532	32	425
3534	34	375
3536	36	395
3538	38	400
3541	41	435
3546M	46	485
3550M	50	525



Combination wrench set

mirror polished, with plastic carrying holder

Juego de llaves combinadas

pulido brillante, en petaca con asa de material plástico

Jogo de chaves de boca-luneta

polidas, com suporte plástico

10
PCS



Art.	○ mm
3556	8-9-10-11-12-13 14-15-17-19

Combination wrench set

mirror polished

Juego de llaves combinadas

pulido brillante

Jogo de chaves de boca-luneta

polidas

13
PCS



Art.	○ mm
3550	8-9-10-11-12-13-14 15-16-17-18-19-22

Combination wrench set

mirror polished

Juego de llaves combinadas

pulido brillante

Jogo de chaves de boca-luneta

polidas

18
PCS

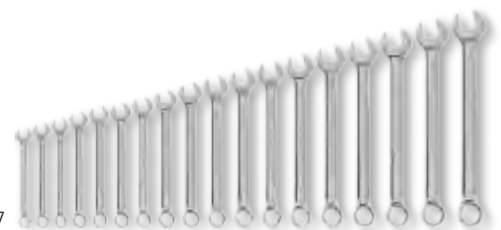

Art. 3557

Art.	○ mm
3557	5.5-6-7-8-9-10-11-12-13-14 15-16-17-18-19-20-21-22
3557R	5.5-6-7-8-9-10-11-12-13-14 15-16-17-18-19-20-21-22



Art. 3557R

Canvas

↕ 540 x 420 mm

Double open-end wrench set

mirror polished

Juego de llaves fijas

pulido brillante

Jogo de chaves de bocas

polidas

Art.	mm
3553	6x7-8x9-10x11-12x13-14x15-16x17 18x19-21x22-24x27-30x32
3553R	6x7-8x9-10x11-12x13-14x15-16x17 18x19-21x22-24x27-30x32

CrV **10**
PCS



Art. 3553



Art. 3553R

Canvas

Combination wrench set

mirror polished

Juego de llaves combinadas

pulido brillante

Jogo de chaves de boca-luneta

polidas

Art.	mm
3558	24-27-30-32
3558R	24-27-30-32

4
PCS



Art. 3558



Art. 3558R

Canvas

485 x 295 mm

Combination wrench set

mirror polished

Juego de llaves combinadas

pulido brillante

Jogo de chaves de boca-luneta

polidas

Art.	mm
3554	5.5-6-7-8-9-10-11-12-13-14-15-16-17-18-19 20-21-22-23-24-25-26-27-28-30-32
3554R	5.5-6-7-8-9-10-11-12-13-14-15-16-17-18-19 20-21-22-23-24-25-26-27-28-30-32

CrV

26
PCS



Art. 3554



Art. 3554R

Canvas

Combination wrench set
of stainless steel

Juego de llaves combinadas
en acero inoxidable

Jogo de chaves de boca-luneta
em aço inoxidável

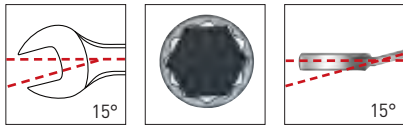

Art.	mm
3503-56	8-10-11-12-13-14-15-17-19

inox

9
PCS



Inch combination wrench
mirror polished

Llave combinada pulgadas
pulido brillante

Chave de boca-luneta polegada
polida

Art.	inch	L mm
3587	1/4"	126
3588	5/16"	139
3589	3/8"	160
3590	7/16"	166
3591	1/2"	178
3592	9/16"	190
3593	5/8"	208
3594	11/16"	226
3595	3/4"	250
3596	13/16"	271
3597	7/8"	294
3598	15/16"	314
3599	1"	335

inch

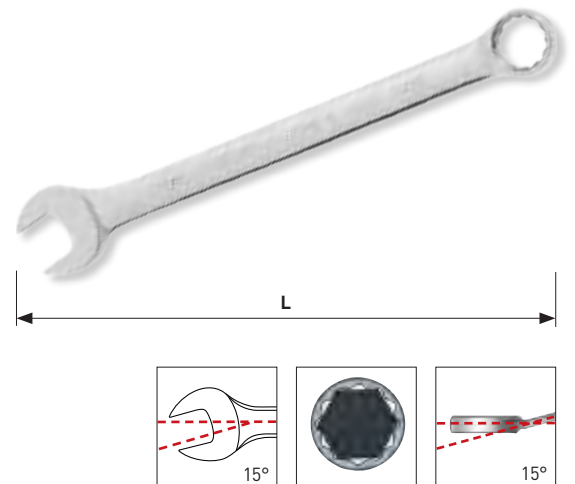

Inch combination wrench set

mirror polished

Juego de llaves combinadas en pulgadas

pulido brillante

Jogo de chaves de boca-luneta polegadas

polidas

inch

11
PCS



Art. 3585

Art.	inch
3585	3/8"-7/16"-1/2"-9/16"-5/8"-11/16" 3/4"-13/16"-7/8"-15/16"-1"
3585R	3/8"-7/16"-1/2"-9/16"-5/8"-11/16" 3/4"-13/16"-7/8"-15/16"-1"



Art. 3585R

Canvas

485 x 400 mm

Inch combination wrench case

mirror polished, with 2 reversible ring ratchet wrenches 4-in-1

Estuche de llaves combinadas en pulgadas

pulido brillante, con 2 llaves poligonales dobles con carraca reversible 4-en-1

Mala de chaves de boca-luneta polegadas

polidas, com 2 chaves luneta com roquete reversível 4-em-1

inch

15
PCS



402 x 173 x 48 mm

4in1

REVERSIBLE CLICKRAFT

A 5/16" Art. Nr. 3404-51612 A 7/16"
B 3/8" B 1/2"

A 9/16" Art. Nr. 3404-91634 A 11/16"
B 5/8" B 3/4"

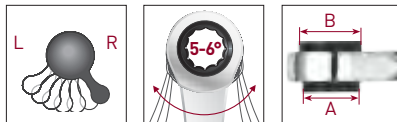

Art.	inch
4900-30K	1/4"-5/16"-3/8"-7/16"-1/2"-9/16"-5/8" 11/16"-3/4"-13/16"-7/8"-15/16"-1"

Double open end wrench

mirror polished

Llave fija

pulido brillante

Chave de bocas

polida

Art.	○ mm	L mm
3560	6 x 7	125
3561	8 x 9	137
3562	10 x 11	149
3551	10 x 13	162
3563	12 x 13	162
3564	14 x 15	188
3565	16 x 17	203
3552	17 x 19	227
3566	18 x 19	227
3567	21 x 22	252
3568	24 x 27	280
3569	30 x 32	310
3579	36 x 41	350
3583	46 x 50	440
3586	55 x 60	505

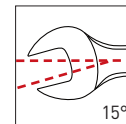

Double open end wrench set

mirror polished

Juego de llaves fijas

pulido brillante

Jogo de chaves de bocas

polidas

Art.	○ mm
3570	6x7-8x9-10x11-12x13-14x15 16x-17-18x19-21x22
3570R	6x7-8x9-10x11-12x13-14x15 16x-17-18x19-21x22

8
PCS



Art. 3570



Art. 3570R

Canvas

↕ 330 x 310 mm

Adjustable angle wrench

with scale

Llave ajustable

con escala

Chave crescente

com escala

Art.	mm	L mm / inch
2404	0 - 14	100 / 4"
2406	0 - 20	150 / 6"
2408	0 - 25	200 / 8"
2410	0 - 30	250 / 10"
2412	0 - 35	300 / 12"
2415	0 - 45	375 / 15"
2418	0 - 55	450 / 18"



Adjustable angle wrench

with specially wide adjustable jaws, slim head with ground jaws and scale in millimeter/inch. Precise and smooth-running guide rail. Parkerized finish.

Llave ajustable

con apertura extra grande, cabeza fina con escala en mm/pulgadas. Precisión y flexibilidad en la separación de las mordazas. Acabado parquerizado.

Chave crescente

Com mandíbulas especialmente longas, cabeça fina com mandíbulas e escala em milímetros/polegada. Carril guia preciso e suave. Acabamento parkerizado.

Art.	mm	L mm / inch
47122	0 - 27	150 / 6"
47123	0 - 34	200 / 8"
47124	0 - 36	250 / 10"
47125	0 - 45	300 / 12"
47120	47122 + 47123 + 47124	

CrV

HIGHTECH



3
PCS



Art. 47120

Canvas

One for many – the Duo Quick universal wrench

with quick adjustment. Release the jaw with one easy pull on the knob. Push the jaw to the screw with the thumb – the jaw is firmly and accurate fixed to the millimeter/inch and shows the screw size on the metric and the inch scale. The Duo Quick wrench replaces every conventional metric or inch wrench up to 24 mm / 1 inch.

Uno para muchos – la llave universal Duo Quick

con ajuste rápido. Libera las bocas simplemente al tirar del botón. Empuje con el dedo pulgar la boca hasta la fijación firme del tornillo, indica la medida del tornillo en escala métrica/pulgada.

La llave Duo Quick reemplaza cualquier llave convencional métrica o en pulgada, hasta 24 mm / 1".

Uma para muitas – A chave crescente Duo Quick

com ajuste rápido. Liberte a maxila com um simples carregar de botão. Acerte a maxila com o parafuso – a maxila está firme e certa na escala de milímetros/polegadas, indicando assim a medida do parafuso na escala. A chave Duo Quick substitui qualquer chave crescente métrica ou polegadas até 24 mm / 1 polegada.



Art.	mm / inch	L mm / inch
3582	0 - 26 / 0 - 1"	200 / 8"

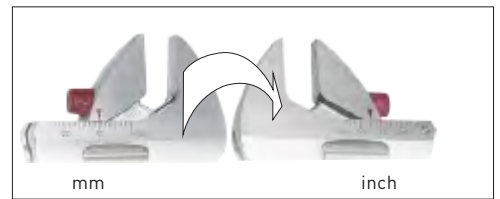
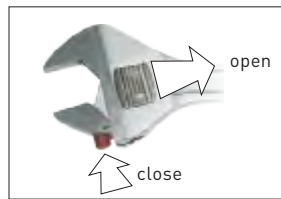
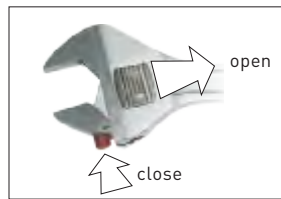

Adjustable ratchet angle wrench

for the fast tightening and loosening of 4-point and 6-point screws/nuts without disengaging the wrench while working. Ratcheting on/off switch to select movable or fixed wrench head. Ergonomic 2-component handle.

CrMo

ERGOKRAFT

Llave ajustable con carraca

para apretar o aflojar los tornillos de 4-6 puntos sin retirar la llave mientras se trabaja. Provisto de un sistema revolucionario para seleccionar cabeza de la llave fija o móvil. Mango ergonómico bimatérica.

Chave crescente com roquete

para apertar e desapertar parafusos com 4 e 6 lados sem retirar a chave. Com um sistema revolucionário para soltar a mandíbula. Punho ergonómico em bi-matéria.

Art.	mm / inch	L mm / inch
3577	0 - 25 / 0 - 1"	210 / 8.27"



mm
inch

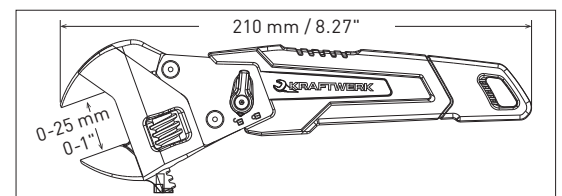
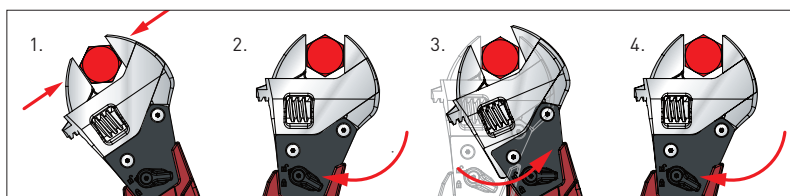

Double offset ring wrench

mirror polished

Llave estrella dos bocas

pulido brillante

Chave de luneta

polida

Art.	○ mm	L mm
3480	6 x 7	165
3481	8 x 9	180
3482	10 x 11	199
3483	12 x 13	218
3484	14 x 15	238
3485	16 x 17	262
3486	18 x 19	287
3487	20 x 22	317
3488	21 x 23	329
3489	24 x 27	346
3491	30 x 32	369
3492	36 x 41	460
3493	46 x 50	520
3494	55 x 60	620



DIN 838 / ISO 1085, 3318, 10104

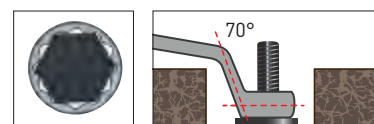

Double offset ring wrench set

mirror polished

Juego de llaves estrella dos bocas

pulido brillante

Jogo de chaves luneta

polidas

Art.	○ mm
3497	6x7-8x9-10x11-12x13-14x15 16x17-18x19-20x22
3497R	6x7-8x9-10x11-12x13-14x15 16x17-18x19-20x22

8
PCS

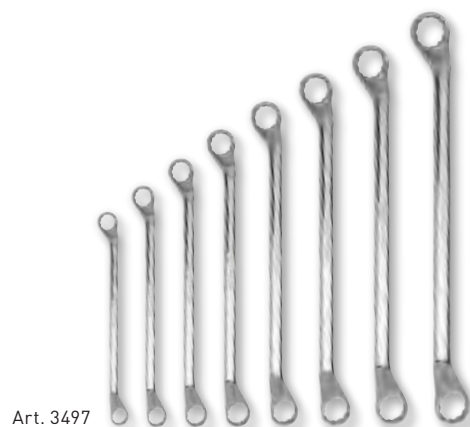

Art. 3497



Art. 3497R

Canvas

↕ 450 x 390 mm

Double offset ring wrench set

mirror polished

Juego de llaves estrella dos bocas

pulido brillante

Jogo de chaves luneta

polidas

Art.	⊙ mm
3498	21x23 - 24x27 - 25x28 - 30x32
3498R	21x23 - 24x27 - 25x28 - 30x32

4
PCS



Art. 3498



Art. 3498R

Canvas

↕ 460 x 325 mm

Double offset ring wrench case

mirror polished

Estuche de llaves estrella dos bocas

pulido brillante

Mala de chaves luneta

polidas

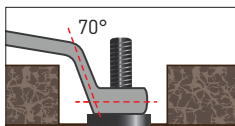

Art.	⊙ mm
4900-15K	6x7-8x9-10x11-12x13-14x15-16x17 18x19-20x22-21x23-24x27-30x32

11
PCS



COMPLETO

↕ 421 x 200 x 68 mm

External TX double ring wrench

flat, mirror polished

Llave de estrella doble TX exterior

recta, pulido brillante

Chave de luneta TX exterior

direita, polida

Art.	⊙ E	L mm
3546	E6 x E8	112
3547	E10 x E12	140
3548	E14 x E18	180
3549	E20 x E24	223

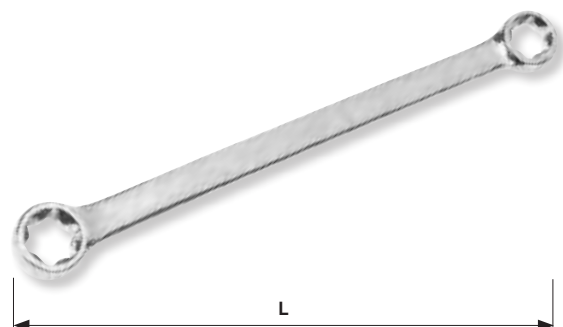

External TX double ring wrench set

flat, mirror polished

Juego de llaves de estrella doble TX exterior

rectas, pulido brillante

Jogo de chaves de luneta TX exterior

direitas, polidas

4
PCS



Art.	⊙ E
3545	E6xE8 - E10xE12 - E14xE18 - E20xE24

Flare nut wrench

mirror polished

Llave para racores

pulido brillante

Chave de luneta aberta

polida

Art.	⊙ mm	⊙ inch	L mm
3580-00	9 x 11		173
3580-01	10 x 12		175
3580-02	13 x 14		208
3580-03	15 x 17		245
3580-04		3/8" x 7/16"	173
3580-05		1/2" x 9/16"	208
3580-06		5/8" x 11/16"	250

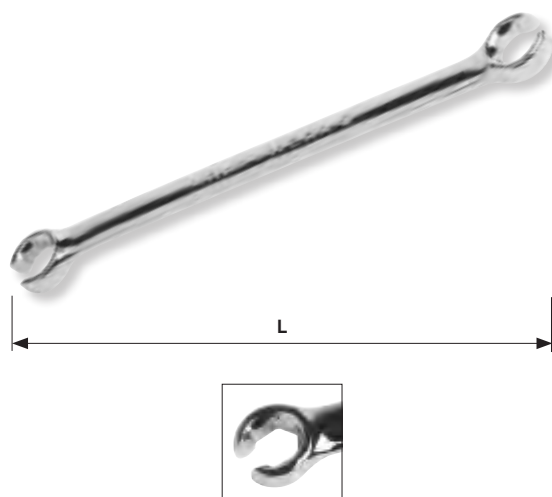

Flare nut wrench set

mirror polished

Juego de llaves para racores

pulido brillante

Jogo de chaves de luneta aberta

polidas

7
PCS



Art.	⊙ mm / inch
3580	9x11 - 10x12 - 13x14 - 15x17 3/8"x7/16" - 1/2"x9/16" - 5/8"x11/16"

Elbow milled angle socket wrench 6 x 6 point

mirror polished

Llave de pipa abierta 6 x 6

pulido brillante

Chave de cachimbo aberta 6 x 6

polida

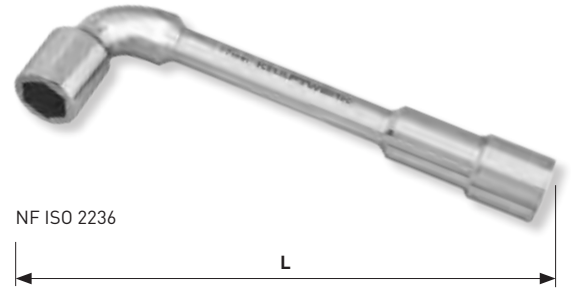

Art.	⊙ mm	L ± mm
2597-06	6	102 ± 3
2597-07	7	106 ± 3
2597-08	8	114 ± 3
2597-09	9	122 ± 3
2597-10	10	129 ± 3
2597-11	11	136 ± 3
2597-12	12	144 ± 4
2597-13	13	152 ± 4
2597-14	14	160 ± 4
2597-15	15	169 ± 4
2597-16	16	178 ± 4
2597-17	17	187 ± 4
2597-18	18	195 ± 4
2597-19	19	204 ± 4
2597-20	20	212 ± 4
2597-21	21	221 ± 5
2597-22	22	230 ± 5
2597-23	23	240 ± 5
2597-24	24	250 ± 5
2597-25	25	260 ± 5
2597-26	26	270 ± 5
2597-27	27	280 ± 5
2597-28	28	290 ± 5
2597-29	29	300 ± 5
2597-30	30	310 ± 5
2597-32	32	330 ± 5

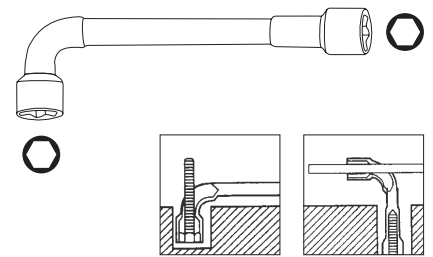

Elbow milled angle socket wrench 12 x 6 point

mirror polished

Llave de pipa abierta 12 x 6

pulido brillante

Chave de cachimbo aberta 12 x 6

polida



Art.	Ø mm	L ± mm
2598-06	6	102 ± 3
2598-07	7	106 ± 3
2598-08	8	114 ± 3
2598-09	9	122 ± 3
2598-10	10	129 ± 3
2598-11	11	136 ± 3
2598-12	12	144 ± 4
2598-13	13	152 ± 4
2598-14	14	160 ± 4
2598-15	15	169 ± 4
2598-16	16	178 ± 4
2598-17	17	187 ± 4
2598-18	18	195 ± 4
2598-19	19	204 ± 4
2598-20	20	212 ± 4
2598-21	21	221 ± 5
2598-22	22	230 ± 5
2598-23	23	240 ± 5
2598-24	24	250 ± 5
2598-25	25	260 ± 5
2598-26	26	270 ± 5
2598-27	27	280 ± 5
2598-28	28	290 ± 5
2598-29	29	300 ± 5
2598-30	30	310 ± 5
2598-32	32	330 ± 5
2598-34	34	350 ± 5



NF ISO 2236

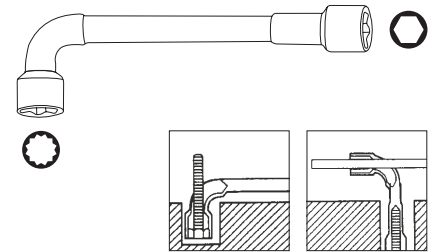

Elbow milled angle socket wrench set
mirror polished

Juego de llaves de pipa abiertas
pulido brillante

Jogo de chaves de cachimbo abertas
polidas

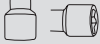
Art.		mm
2597-99	○ ○	8-10-11-12-13-14-16-17-18-19
2598-99	○ ○	8-10-11-12-13-14-16-17-18-19



10
PCS



Elbow milled open socket wrench case
mirror polished

Estuche de llaves de pipa abiertas
pulido brillante

Mala de chaves de cachimbo abertas
polidas

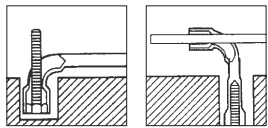

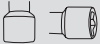
Art.		mm
4900-48K	○ ○	8-9-10-11-12-13-14-15 16-17-18-19-22
4900-18K	○ ○	8-9-10-11-12-13-14-15 16-17-18-19-22



13
PCS



COMPLETO

421 x 200 x 68 mm

Double flexible socket wrench
mirror polished

Llave de vaso doble articulada
pulido brillante

Chave de caixa articulada
polida

Art.	mm	L mm
2590-0809	8 x 9	176
2590-1011	10 x 11	200
2590-1213	12 x 13	216
2590-1415	14 x 15	240
2590-1617	16 x 17	255
2590-1819	18 x 19	270

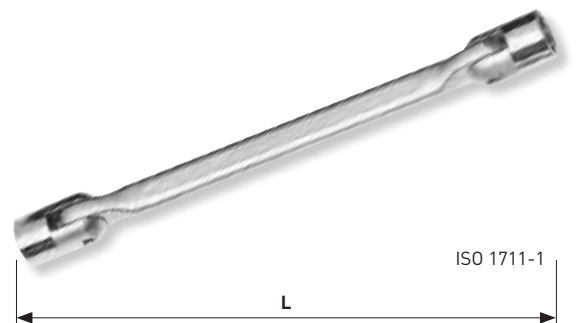

ISO 1711-1

L



Double flexible wrench for sockets

mirror polished

Llave doble articulada para llaves de vaso

pulido brillante

Chave dupla articulada para chaves de caixa

polida

Art.	□	L mm
2590-3814	1/4" x 3/8"	255

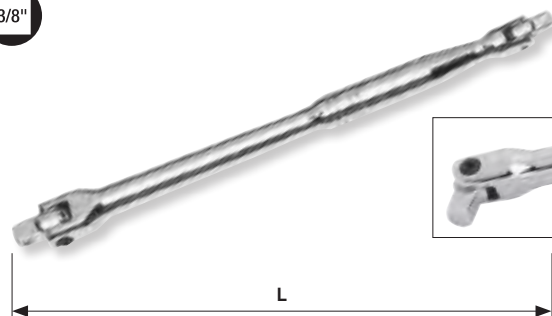

Universal joint spark plug wrench

Llave de bujía articulada

Chave de velas articulada

Art.	○ mm	L mm
2591-16	16	240
2591-21	21	245

AUTOMOTIVE

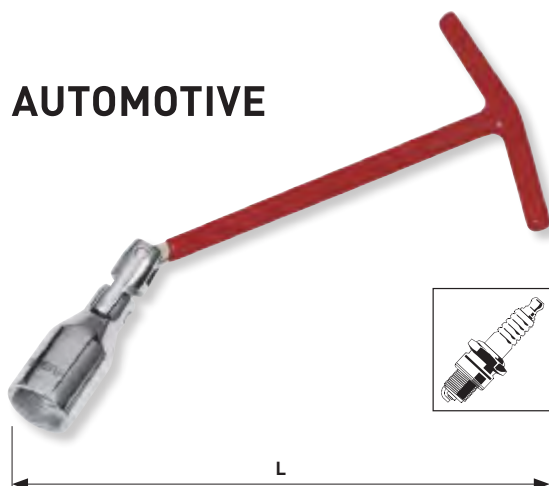

L-type wheel wrench with double socket

extensible

Llave ruedas en L con llave de vaso doble

extensible

Chave de rodas tipo L com chave dupla

extensível

Art.	○ mm	L 1 mm	L 2 mm
2585-1719	17 x 19	365	525
2585-1721	21 x 22	365	525

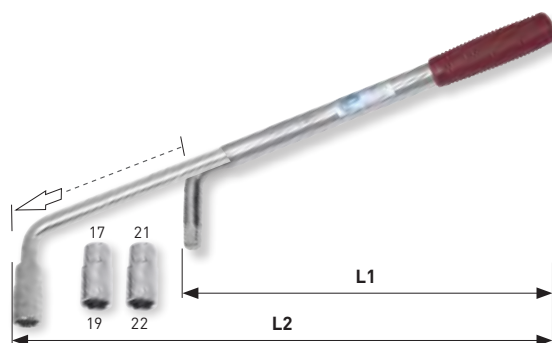

Cross rim wrench

Llave ruedas cruz

Chave de rodas em cruz

Art.	○ mm	□	L mm
2585-12	17-19-22	1/2"	375
2585-34	24-27-32	3/4"	625



T-type universal socket

extra long

Llave de vaso en T muletilla

extra larga

Chave de caixa cabo em "T"

extra longa

Art.	⊙ mm	L mm
2592-08	8	390
2592-09	9	390
2592-10	10	495
2592-11	11	495
2592-12	12	495
2592-13	13	495
2592-14	14	495
2592-15	15	495
2592-16	16	495
2592-17	17	495
2592-18	18	495
2592-19	19	495

XXL

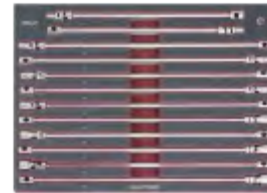
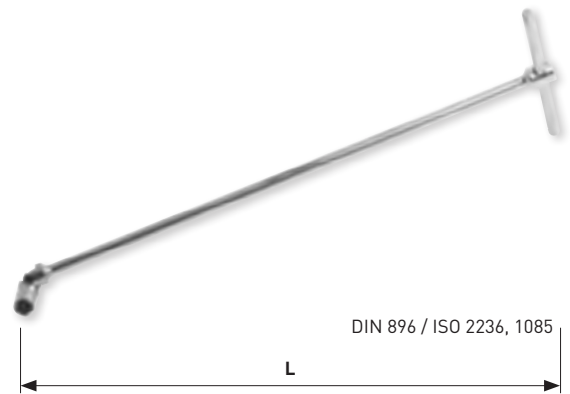

Art. 4902-07
95

Double end tubular socket wrench

light serie

Llave de tubo de dos bocas

serie ligera

Chave de tubos direita

série ligeira

Art.	⊙ mm	∅ mm	L mm
2589-0607	6 x 7	5	108
2589-0809	8 x 9	5	110
2589-1011	10 x 11	5	122
2589-1213	12 x 13	5	142
2589-1415	14 x 15	8	143
2589-1617	16 x 17	10	146
2589-1819	18 x 19	10	158
2589-2022	20 x 22	10	175
2589-2123	21 x 23	12	175
2589-2427	24 x 27	12	185
2589-2528	25 x 28	12	190
2589-3032	30 x 32	12	205

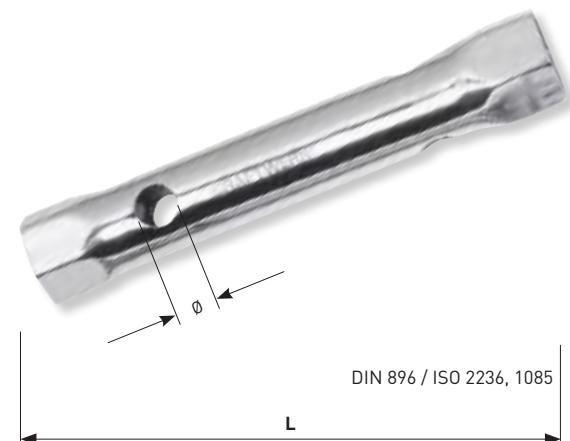

Double end tubular socket wrench set

light serie

Juego de llaves de tubo de dos bocas

serie ligera

Jogo de chaves de tubos direita

série ligeira

Art.	mm	Ø mm
2589-01	6x7-8x9-10x11-12x13 14x15-16x17-18x19-20x22	5-8-10

9
PCS



Canvas

↕ 325 x 240 mm

Double end tubular socket wrench set

light serie

Juego de llaves de tubo de dos bocas

serie ligera

Jogo de chaves de tubos direita

série ligeira

Art.	mm	Ø mm
2589-02	21x23 - 24x27 - 25x28 - 30x32	12+14

6
PCS



Canvas

↕ 370 x 345 mm

Stepped tommy bar

for double end tubular socket wrenches

Pasador

para llaves de tubo de dos bocas

Barra T escalonada

para chaves de tubos direita

Art.	Ø mm	L mm
2599-3457	3.5 - 4.5 - 5.5 - 7.5	165
2589-5810	5 - 8 - 10	190
2599-1012	10 - 12	210

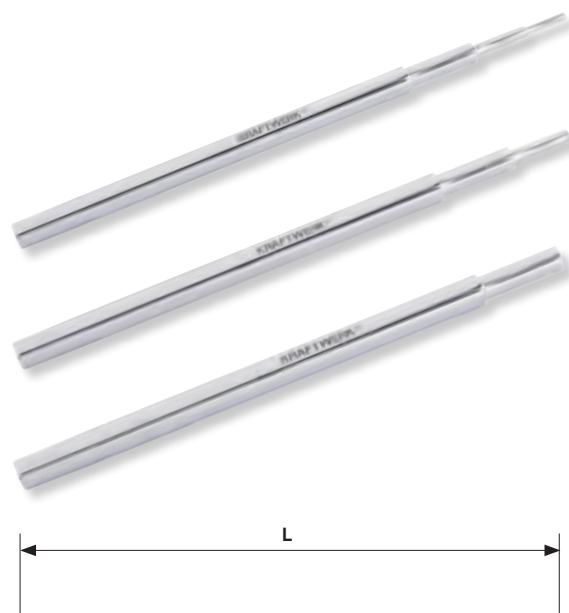

Double end tubular socket wrench

heavy duty serie, made by CNC-machining

Llave de tubo de dos bocas

serie fuerte, fabricada con precisión CNC

Chave de tubos direita

série maciça, fabricada com precisão CNC

Art.	mm	Ø mm	L mm
2599-0607	6 x 7	3.5	105
2599-0809	8 x 9	3.5	110
2599-1011	10 x 11	4.5	120
2599-1213	12 x 13	5.5	138
2599-1415	14 x 15	5.5	145
2599-1617	16 x 17	8	152
2599-1819	18 x 19	8	162
2599-2022	20 x 22	10	175
2599-2123	21 x 23	10	185
2599-2427	24 x 27	12	195
2599-2528	25 x 28	12	205
2599-3032	30 x 32	12	210

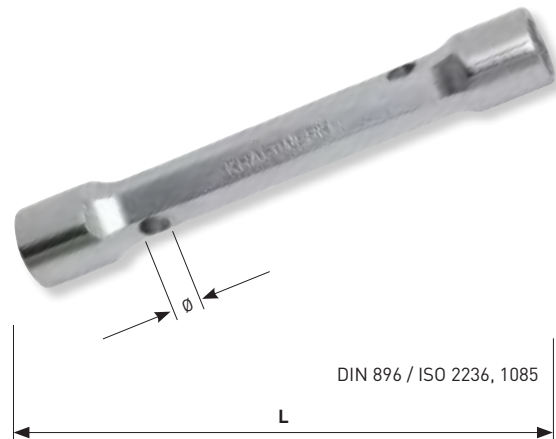

Double end tubular socket wrench set

heavy duty serie, made by CNC-machining

Juego de llaves de tubo de dos bocas

serie fuerte, fabricada con precisión CNC

Jogo de chaves de tubos direita

série maciça, fabricada com precisão CNC

Art.	mm	Ø mm
2599-01	6x7-8x9-10x11-12x13 14x15-16x17-18x19-20x22	5-8-10

9
PCS



Canvas

325 x 240 mm

Double end tubular socket wrench set

heavy duty serie, made by CNC-machining

Juego de llaves de tubo de dos bocas

serie fuerte, fabricada con precisión CNC

Jogo de chaves de tubos direita

série maciça, fabricada com precisão CNC

Art.	○ mm	∅ mm
2599-02	21x23 - 24x27 - 25x28 - 30x32	10+12

6
PCS



Canvas

↕ 370 x 345 mm

Ring ratchet wrench set for tubes

Juego de llaves poligonales con carraca para racores

Jogo de chaves luneta com roquete para racores

Art.
2586

CrMo 8
PCS



Canvas

Reversible ratchet head

Cabeza carraca reversible

Cabeça de roquete reservível

Art.	■
3584-U14	1/4"
3584-U38	3/8"

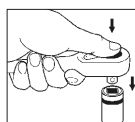

48







ergonomic **powerful**
ergonómico fuerte
ergonômico **forte**



Round, smooth handle-head for frictionless gliding in the hand.

Extremo del mango redondeado y liso que evita el roce con la palma de la mano.

Extremidade do cabo arredondado e polido que evita a fricção com a palma da mão.



Large oval hole for comfortable hanging-up at a tool wall.

Orificio ovalado para colgar.

O furo ovalizado permite deixar a chave de fenda pendurada.



Ergonomical handle of two components material.

Mango ergonómico bimatierial.

Cabo ergonómico composto por dois materiais.

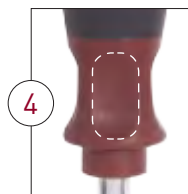

Finger-recessed surface and sliding protected shape.

Endidura para dedos, forma antideslizante.

Concavidade para dedos e forma anti-deslizante.



S2-steel for professional continuous use.

Acero S2 para uso profesional de larga duración.

Aço S2 para uso contínuo profissional.

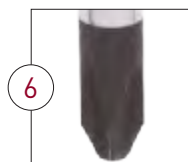

Precise tip in accordance with DIN/ISO-specifications.



Punta precisa en conformidad con las normas DIN/ISO.

Ponta de precisão em conformidade com as normas DIN/ISO.

Screwdriver for slotted screws

Destornillador para tornillos de ranura

Chave de fenda

Art.	 mm	 mm	L1 mm	L2 mm
4110-1	0.6	3	75	150
4110-2	0.8	4	100	180
4110-3	1.0	5	100	205
4110-4	1.1	6	150	255
4110-5	1.2	8	150	265
4110-6	1.6	10	200	315



Stubby screwdriver for slotted screws

Destornillador extracorto para tornillos de ranura

Coto chave de fenda

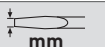
Art.	 mm	 mm	L1 mm	L2 mm
4112-2	1.1	6	38	93

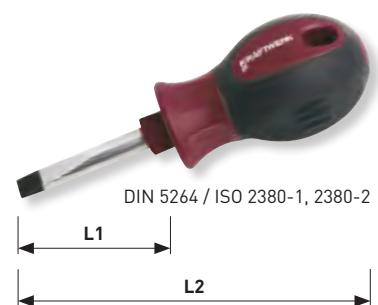

Impact screwdriver

for slotted screws. Go-through blade and striking cap on the handle. Special solid, impact-resistant black-point tip, hexagon blade and multi-components power form handle for highest torque and best ergonomomy.

Destornillador de golpeo

para tornillos de ranura. Hoja integrada en el mango. Punto de golpe sólido y resistente, hoja hexagonal y mango multicomponentes para mayor fuerza y ergonomía.

Chave de fenda de impacto

Lâmina completa com batente no cabo para impacto. Sólido, resistência ao impacto com ponta negra. Lâmina hexagonal e multi-componentes no cabo para um torque maior e melhor ergonomia.

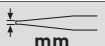
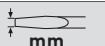
Art.	 mm	 mm	L1 mm	L2 mm
4140-3	1.0	5.5	100	209
4140-4	1.2	6.5	125	233
4140-5	1.4	8.0	150	268
4140-6	1.5	10.0	175	295

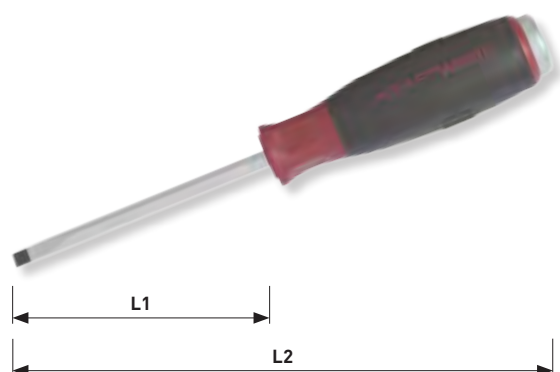

Screwdriver for Phillips screws
Destornillador para tornillos Phillips
Chave Phillips



Art.	+	L1 mm	L2 mm
4115-0	PH 0	75	150
4115-1	PH 1	75	178
4115-2	PH 2	100	205
4115-3	PH 3	150	265



Stubby screwdriver for Phillips screws
Destornillador extracorto para tornillos Phillips
Coto chave Phillips



Art.	+	L1 mm	L2 mm
4117-2	PH 2	38	93

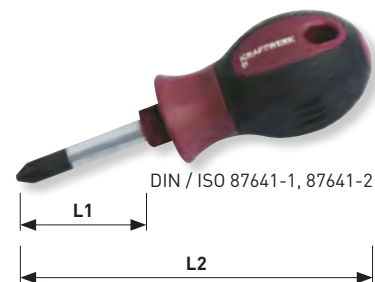

Impact screwdriver

for Phillips screws. Go-through blade and striking cap on the handle. Special solid, impact-resistant black-point tip, hexagon blade and multi-components power form handle for highest torque and best ergonomomy.

Destornillador de golpeo

para tornillos Phillips. Hoja integrada en el mango. Punto de golpe sólido y resistente, hoja hexagonal y mango multicomponentes para mayor fuerza y ergonomía.

Chave Phillips de impacto

Lâmina completa com batente no cabo para impacto. Sólido, resistencia ao impacto com ponta negra. Lâmina hexagonal e multi-componentes no cabo para um torque maior e melhor ergonomia.



Art.	+	L1 mm	L2 mm
4145-1	PH 1	75	185
4145-2	PH 2	100	209



Screwdriver for Pozidriv screws Destornillador para tornillos Pozidriv Chave Pozidriv

Art.		L1 mm	L2 mm
4120-0	PZ 0	75	150
4120-1	PZ 1	75	178
4120-2	PZ 2	100	205
4120-3	PZ 3	150	265



Impact screwdriver

for Pozidriv screws. Go-through blade and striking cap on the handle. Special solid, impact-resistant black-point tip, hexagon blade and multi-components power form handle for highest torque and best ergonomomy.

Destornillador de golpeo

para tornillos Pozidriv. Hoja integrada en el mango. Punto de golpe sólido y resistente, hoja hexagonal y mango multicomponentes para mayor fuerza y ergonomía.



Chave Pozidriv de impacto

Lâmina completa com batente no cabo para impacto. Sólido, resistencia ao impacto com ponta negra. Lâmina hexagonal e multi-componentes no cabo para um torque maior e melhor ergonomia.

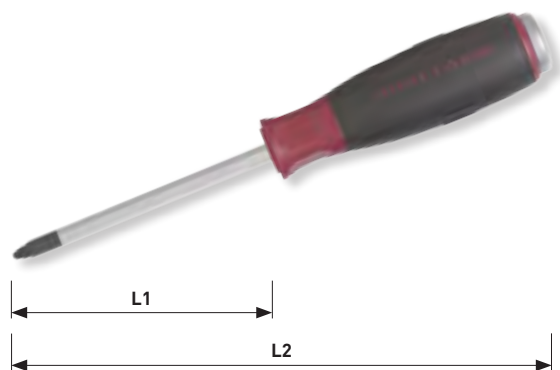
Art.		L1 mm	L2 mm
4150-1	PZ 1	75	185
4150-2	PZ 2	100	209



Screwdriver for TX screws Destornillador para tornillos TX Chave TX

Art.		 mm	L1 mm	L2 mm
4125-08	T8	2.3	75	153
4125-10	T10	2.7	100	205
4125-15	T15	3.3	100	205
4125-20	T20	3.8	100	205
4125-25	T25	4.4	100	205
4125-27	T27	5.0	100	205
4125-30	T30	5.5	100	205
4125-40	T40	6.6	100	205



Screwdriver for TX screws

with bore hole at the tip, for normal TX screws and tamperproof TX screws

Destornillador para tornillos TX

con punta perforada, para tornillos con y sin punta de seguridad

Chave TX

com furo, para parafusos normais e de segurança



S2
quality

Art.		mm	L1 mm	L2 mm
4126-08	T8	2.3	75	153
4126-10	T10	2.7	100	205
4126-15	T15	3.3	100	205
4126-20	T20	3.8	100	205
4126-25	T25	4.4	100	205
4126-27	T27	5.0	100	205
4126-30	T30	5.5	100	205
4126-40	T40	6.6	100	205



Screwdriver set

for slotted and Phillips screws

Juego de destornilladores

para tornillos de ranura y Phillips

Jogo de chaves

de parafuso fenda e Phillips

	Art. 4110-1	0.6 x 3 mm
	Art. 4110-2	0.8 x 4 mm
	Art. 4110-3	1.0 x 5 mm
	Art. 4115-1	PH 1
	Art. 4115-2	PH 2

Art.
4162



S2
quality

5
PCS



Screwdriver set



for slotted and Pozidriv screws

Juego de destornilladores

para tornillos de ranura y Pozidriv

Jogo de chaves

de parafuso fenda e Pozidriv

	—	Art. 4110-1	0.6 x 3 mm
		Art. 4110-2	0.8 x 4 mm
		Art. 4110-3	1.0 x 5 mm
	+	Art. 4120-1	PZ 1
		Art. 4120-2	PZ 2

Art.

4163

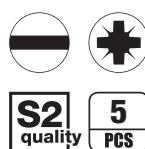

Screwdriver set



for slotted and Phillips screws

Juego de destornilladores

para tornillos de ranura y Phillips

Jogo de chaves

de parafuso fenda e Phillips

	—	Art. 4110-1	0.6 x 3 mm
		Art. 4110-2	0.8 x 4 mm
		Art. 4110-3	1.0 x 5 mm
		Art. 4110-4	1.1 x 6 mm
		Art. 4110-5	1.2 x 8 mm
	+	Art. 4115-1	PH 1
		Art. 4115-2	PH 2

Art.

4160

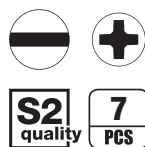

Screwdriver set



for slotted and Pozidriv screws

Juego de destornilladores

para tornillos de ranura y Pozidriv

Jogo de chaves

de parafuso fenda e Pozidriv

	—	Art. 4110-1	0.6 x 3 mm
		Art. 4110-2	0.8 x 4 mm
		Art. 4110-3	1.0 x 5 mm
		Art. 4110-4	1.1 x 6 mm
		Art. 4110-5	1.2 x 8 mm
	+	Art. 4120-1	PZ 1
		Art. 4120-2	PZ 2

Art.

4161

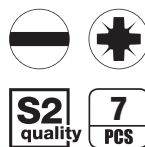

Screwdriver set

for TX screws

Juego de destornilladores

para tornillos TX

Jogo de chaves

de parafuso TX



Art. 4125-08	T8
Art. 4125-10	T10
Art. 4125-15	T15
Art. 4125-20	T20
Art. 4125-25	T25
Art. 4125-27	T27
Art. 4125-30	T30
Art. 4125-40	T40

Art.

4165



S2
quality

8
PCS



Screwdriver set

with bore hole at the tip, for normal TX screws and tamperproof TX screws

Juego de destornilladores

con punta perforada, para tornillos TX con y sin punta de seguridad

Jogo de chaves de parafuso

com furo, para parafusos TX e de segurança



Art. 4126-08	T8
Art. 4126-10	T10
Art. 4126-15	T15
Art. 4126-20	T20
Art. 4126-25	T25
Art. 4126-27	T27
Art. 4126-30	T30
Art. 4126-40	T40

Art.

4166



S2
quality

8
PCS



Universal screwdriver-/bit case

for slotted, Phillips, Pozidriv and TX screws

Estuche de destornilladores/puntas

para tornillos de ranura, Phillips, Pozidriv y TX

Mala de chaves de parafuso e bits

para parafusos de fenda, Phillips, Pozidriv e TX

	Art. 4110-1	0.6 x 3 mm
	Art. 4110-2	0.8 x 4 mm
	Art. 4110-3	1.0 x 5 mm
	Art. 4110-4	1.1 x 6 mm
	Art. 4110-5	1.2 x 8 mm
	Art. 4110-6	1.6 x 10 mm

	Art. 4112-2	1.1 x 6 mm
---	-------------	------------

	Art. 4115-0	PH 0
	Art. 4115-1	PH 1
	Art. 4115-2	PH 2
	Art. 4115-3	PH 3

	Art. 4117-2	PH 2
---	-------------	------

	Art. 4120-0	PZ 0
	Art. 4120-1	PZ 1
	Art. 4120-2	PZ 2
	Art. 4120-3	PZ 3

	Art. 4128	1/4"
---	-----------	------

	T10-T15-T20-T25-T27-T30-T40	
---	-----------------------------	--

Art.

4168



S2 quality 24 PCS



380 x 250 x 72 mm

Screwdriver case

for slotted and Phillips screws

Estuche de destornilladores

para tornillos de ranura y Phillips

Mala de chaves



de parafuso fenda e Phillips

	Art. 4110-1	0.6 x 3 mm
	Art. 4110-2	0.8 x 4 mm
	Art. 4110-3	1.0 x 5 mm
	Art. 4110-4	1.1 x 6 mm
	Art. 4110-5	1.2 x 8 mm

	Art. 4112-2	1.1 x 6 mm
---	-------------	------------

	Art. 4115-1	PH 1
	Art. 4115-2	PH 2

	Art. 4117-2	PH 2
---	-------------	------

	Art. 2138	100-250V	
---	-----------	----------	---

	Art. 2139	12V
---	-----------	-----

Art.

4900-04K



S2 quality 11 PCS

COMPLETO



421 x 200 x 68 mm

Screwdriver case

for TX screws and little slotted and Phillips screws

Estuche de destornilladores

para tornillos TX y para tornillos pequeños de ranura y Phillips

Mala de chaves

de parafuso TX e para parafusos pequenos fenda e Phillips

	★	Art. 4125-08	T8
		Art. 4125-10	T10
		Art. 4125-15	T15
		Art. 4125-20	T20
		Art. 4125-25	T25
		Art. 4125-27	T27
		Art. 4125-30	T30
		Art. 4125-40	T40

	—	Art. 3177-20	0.45 x 2.0 mm
		Art. 3177-24	0.5 x 2.4 mm
		Art. 3177-30	0.6 x 3.0 mm
		Art. 3177-35	0.65 x 3.5 mm

	+	Art. 3177-0	PH 0
		Art. 3177-1	PH 1

Art. **4900-05K**

— + ★

S2 quality 14 PCS



↕ 421 x 200 x 68 mm

COMPLETO

Impact screwdriver case

for slotted, Phillips and Pozidriv screws

- go-through blade and striking cap on the handle
- special solid, impact-resistant black-point tip
- hexagon blade
- Multi-components power form handle for highest torque and best ergonomomy

Bandeja de destornilladores de golpeo

para tornillos de ranura, Phillips y Pozidriv

- hoja integrada en el mango
- punto de golpe sólido y resistente
- hoja hexagonal
- mango multicomponentes para mayor fuerza y ergonomía

Mala de chaves de parafusos de impacto

para parafuso fenda, Phillips e Pozidriv

- lâmina completa com batente no cabo para impacto
- Sólido, resistente ao impacto com ponta negra
- lâmina hexagonal
- multi-componentes no cabo para um torque maior e melhor ergonomia

	—	Art. 4140-3	5.5 x 100 mm	5.5 mm
		Art. 4140-4	6.5 x 125 mm	6.5 mm
		Art. 4140-5	8.0 x 150 mm	8.0 mm
		Art. 4140-6	10.0 x 175 mm	10.0 mm

	+	Art. 4145-1	PH1 x 75 mm	5.0 mm
		Art. 4145-2	PH2 x 100 mm	6.0 mm

	+	Art. 4150-1	PZ1 x 75 mm	5.0 mm
		Art. 4150-2	PZ2 x 100 mm	6.0 mm

Art. **4900-54K**

— + ★

S2 quality 8 PCS



↕ 402 x 173 x 48 mm

COMPLETO





Screwdriver set

of stainless steel, for slotted, Phillips and Pozidriv screws

Juego de destornilladores

en acero inoxidable, para tornillos de ranura, Phillips y Pozidriv

Jogo de chaves de parafuso

em aço inoxidável, para parafuso fenda, Phillips e Pozidriv

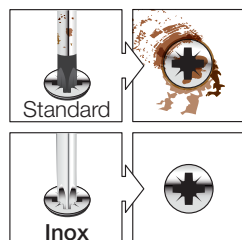
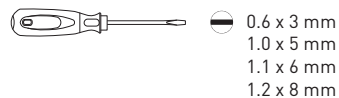

Art.
4170

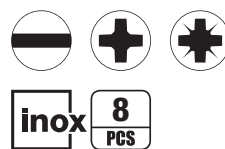

Reversible ratchet blade screwdriver set

with 8 double end blades (= 16 screwdrivers) and blade with bit-adaptor. Variable blade-length setting 50 - 150 mm.

Juego de destornilladores reversibles con carraca

con 8 hojas reversibles (=16 destornilladores) y hoja adaptador para puntas. Largo variable de la hoja: 50 a 150 mm.

Jogo de chaves de parafusos com roquete reversível

com 8 lâminas reversíveis (= 16 chaves de fenda) e lâmina com adaptador para bits. Comprimento variável de lâmina 50-150 mm.

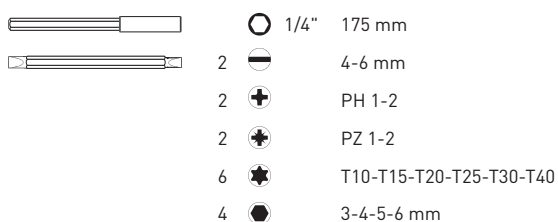

Art.	L mm
4135	175

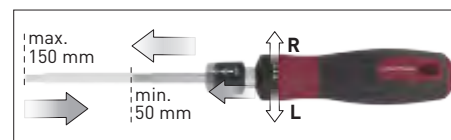

ERGOKRAFT

Screwdriver-/bit case

for slotted and Phillips screws and many little screws

Juego de destornilladores/puntas

para tornillos de ranura y Phillips y muchos pequeños tornillos

Jogo de chaves de parafuso e bits

para parafusos de fenda e Phillips e muitos parafusos pequenos



4 0.6 x 3 - 0.8 x 4 - 1.0 x 5 - 1.1 x 6 mm

2 PH 1-2



Art.
4164



Hexagon nut spinner

Destornillador stecker

Chave de caixa sextavada com punho



ERGOKRAFT

Art.	mm	L1 mm	L2 mm
4127-055	5.5	150	255
4127-06	6	150	255
4127-07	7	150	255
4127-08	8	150	265
4127-10	10	150	265
4127-11	11	150	265
4127-12	12	150	265
4127-13	13	150	265

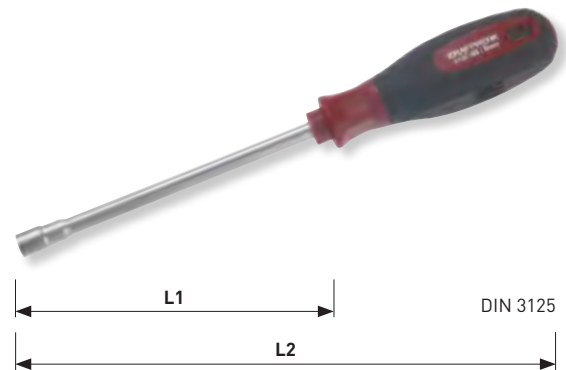

Hexagon nut spinner case
Estuche de destornilladores stecker
Mala de chaves de caixa sextavada com punho



CrV 8
PCS

COMPLETO

	Art. 4127-055	5.5 mm
	Art. 4127-06	6 mm
	Art. 4127-07	7 mm
	Art. 4127-08	8 mm
	Art. 4127-10	10 mm
	Art. 4127-11	11 mm
	Art. 4127-12	12 mm
	Art. 4127-13	13 mm

Art.

4900-31K



↕ 421 x 200 x 68 mm

Bit-driver

magnetic

Destornillador portapuntas

magnético

Chave de parafuso porta-bits

magnética

Art.	Ø	L1 mm	L2 mm
4128	1/4"	100	205
4130	5/16"	100	205

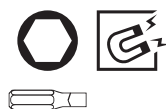

ERGOKRAFT

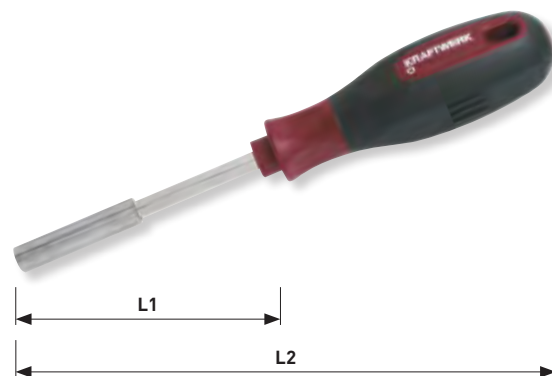

Flexible hexagon nut spinner

Llave de vaso con mango destornillador flexible

Chave de caixa sextavada flexível com punho

Art.	Ø mm	L1 mm	L2 mm
109060	6	158	270
109070	7	158	270
109080	8	158	270
109090	9	176	292
109100	10	176	292
109110	11	176	292



ERGOKRAFT

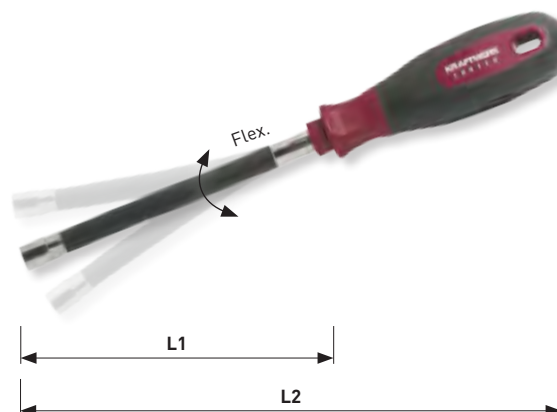

Spinner handle

with 1/4" square drive in end of handle

Mango atornillador

con cuadrado interior 1/4" en el extremo del mango

Extensão com punho

com quadrado interior 1/4" na extremidade do punho

Art.	Ø	L1 mm	L2 mm
109150	1/4"	70	150



DIN 3122 / ISO 3315

Bi-material spinner handle

with 1/4" square drive in end of handle

Mango atornillador bimaterial

con cuadrado interior 1/4" en el extremo del mango

Extensão com punho bimaterial

com quadrado interior 1/4" na extremidade do punho

Art.		L1 mm	L2 mm
109151	1/4"	51	153

Bi-material flexible spinner handle

Mango atornillador flexible bimaterial

Chave de punho flexível bimaterial

Art.		L1 mm	L2 mm
109175	1/4"	158	270

10 in 1 universal cross recess screwdriver

for PH + PZ Nos 0-1-2-3-4 with double-sided blade for Phillips screws on one side and Pozidriv screws on the other side.

Destornillador universal cruciforme 10 en 1

PH+PZ, no. 0-1-2-3-4, varilla extraíble para tornillos PH en una parte y PZ en la otra.

10 em 1 chave de cruz universal

para PH + PZ Nr° 0-1-2-3-4 com lâmina dupla de um lado Philips e do outro lado Pozidriv.

Art.		L1 mm	L2 mm
4132	PH 0-1-2-3-4 PZ 0-1-2-3-4	103	215

Magnetic converter for screwdrivers

Magnetizador para destornilladores

Magnetizador para chaves de parafusos

Art.
2187



ERGOKRAFT



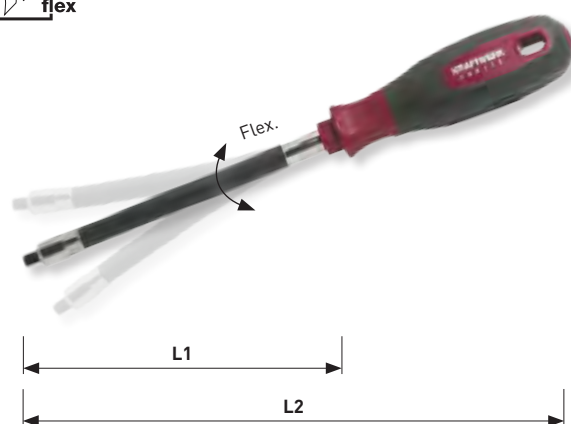

ERGOKRAFT

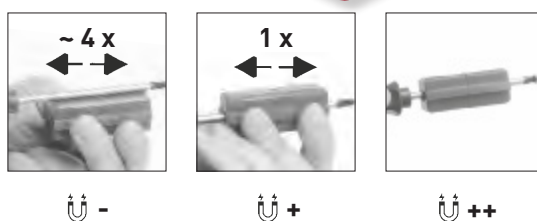
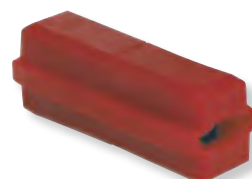

ERGOKRAFT



Electrician-screwdriver for slotted screws
Destornillador aislado para electricista para tornillos de ranura
Chave de fenda isolada para electricista

Art.	 mm	 mm	L1 mm	L2 mm
3132-1	0.4	2.5	75	155
3132-2	0.8	3.0	100	180
3132-3	1.0	3.5	100	180
3132-4	1.2	4.0	100	180



 1000 V



Electrician-screwdriver for Phillips screws
Destornillador aislado para electricista para tornillos Phillips
Chave isolada Phillips para electricista

Art.		L1 mm	L2 mm
3135-0	PH 0	60	140
3135-1	PH 1	80	160
3135-2	PH 2	100	205



 1000 V

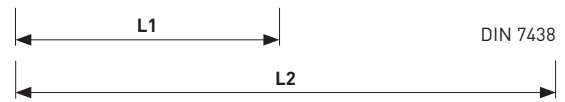

Electrician-screwdriver for Pozidriv screws
Destornillador aislado para electricista para tornillos Pozidriv
Chave isolada Pozidriv para electricista



Art.		L1 mm	L2 mm
3137-0	PZ 0	60	140
3137-1	PZ 1	80	160
3137-2	PZ 2	100	205



 1000 V



Electrician-screwdriver for TX screws
Destornillador aislado para electricista para tornillos TX
Chave isolada TX para electricista

Art.		 mm	L1 mm	L2 mm
3133-15	T15	3.3	100	180
3133-20	T20	3.8	100	180



 1000 V



Electrician-screwdriver-set



for slotted and Phillips screws

Juego de destornilladores aislados para electricista

para tornillos de ranura y Phillips

Jogo de chaves de parafuso

fenda e Phillips isoladas para electricista

	⊖	Art. 3132-1	2.5 x 75 mm
		Art. 3132-4	4.0 x 100 mm
		Art. 3132-5	5.5 x 125 mm
		Art. 3132-6	6.5 x 150 mm
	⊕	Art. 3135-0	PH 0 x 60 mm
		Art. 3135-1	PH 1 x 80 mm
		Art. 3135-2	PH 2 x 100 mm
	⊖	Art. 2138	100-250 V

Art.

3157



Voltage tester 100-250 V

Detector voltaje 100-250 V

Chave busca-polos 100-250 V

Art.	 mm	L1 mm	L2 mm
2138	3	60	140

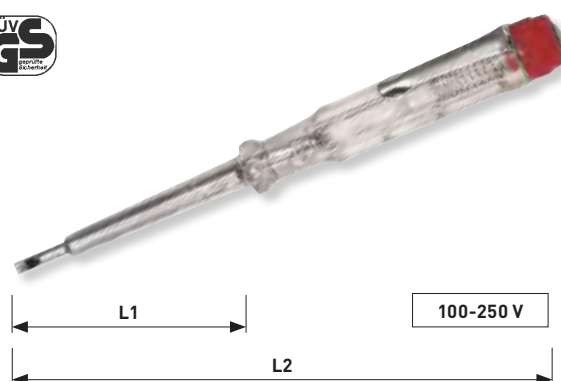

Voltage tester 12 V

Detector voltaje 12 V

Chave busca-polos 12 V

Art.

2139



12 V

T-handle bit-driver

magnetic

Destornillador portapuntas con mango T magnético

Chave T de parafuso com porta-bits magnética

Art.	L1 mm	L2 mm
3634	150	210

Ballpoint hexagon T-handle screwdriver

Destornillador hexagonal acodado con cabeza esférica y mango T

Chave em "T" sextavada interior com ponta esférica

Art.	mm	L1 mm	L2 mm
3636-2	2	100	145
3636-2.5	2.5	100	145
3636-3	3	100	140
3636-4	4	150	195
3636-5	5	150	210
3636-6	6	150	210
3636-7	7	150	210
3636-8	8	200	260
3636-10	10	200	280
3636-12	12	200	280

Ballpoint hexagon T-handle screwdriver case

Estuche de destornilladores hexagonales acodados con cabeza esférica y mango T

Mala de chaves em "T" sextavadas interior com ponta esférica

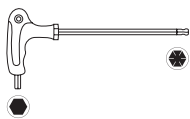

- Art. 3636-3 3 mm
- Art. 3636-4 4 mm
- Art. 3636-5 5 mm
- Art. 3636-6 6 mm
- Art. 3636-7 7 mm
- Art. 3636-8 8 mm
- Art. 3636-10 10 mm



Art.
4900-25K

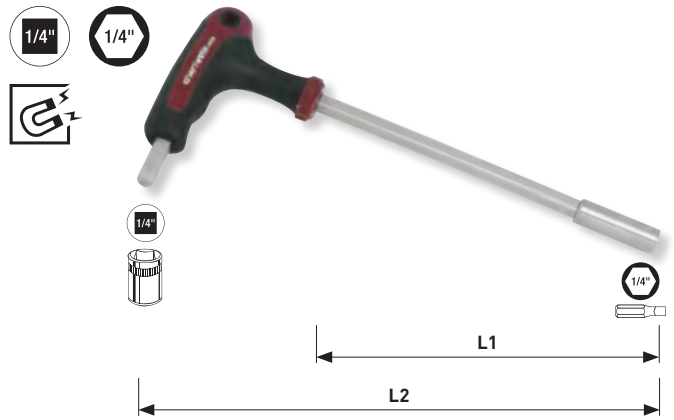

TX T-handle screwdriver



with bore hole at the short tip, for normal TX screws and tamperproof TX screws

Destornillador TX con mango T

con punta corta perforada, para tornillos con y sin punta de seguridad

Chave em "T" TX

com furo na ponta curta, para parafusos com e sem ponta de segurança

Art.		 mm	L1 mm	L2 mm
3637-10	T10	2.7	100	145
3637-15	T15	3.3	100	145
3637-20	T20	3.8	100	145
3637-25	T25	4.4	150	210
3637-27	T27	5.0	150	210
3637-30	T30	5.5	150	210
3637-40	T40	6.6	200	260
3637-45	T45	7.82	200	260
3637-50	T50	8.83	200	280
3637-55	T55	11.22	200	280



S2
quality



TX T-handle screwdriver case

with bore hole at the short tip, for normal TX screws and tamperproof TX screws

Estuche de destornilladores TX con mango T

con punta corta perforada, para tornillos con y sin punta de seguridad

Mala de chaves em "T" TX

com furo em ponta curta, para parafusos com e sem ponta de segurança

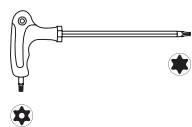

Art. 3637-10 T10
 Art. 3637-15 T15
 Art. 3637-20 T20
 Art. 3637-25 T25
 Art. 3637-27 T27
 Art. 3637-30 T30
 Art. 3637-40 T40

Art.

4900-26K



S2
quality

7
PCS

COMPLETO





 421 x 200 x 68 mm

Precision screwdriver for slotted screws

Destornillador de precisión para tornillos de ranura

Chave de precisão fenda



Art.	 mm	 mm	L1 mm	L2 mm
3177-15	0.4	1.5	50	150
3177-20	0.45	2.0	50	150
3177-24	0.5	2.4	50	150
3177-30	0.6	3.0	50	150
3177-35	0.65	3.5	50	150
3177-40	0.8	4.0	50	150

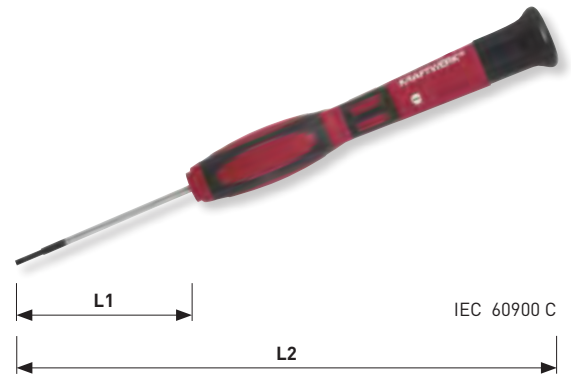

Precision screwdriver for Phillips screws

Destornillador de precisión para tornillos Phillips

Chave de precisão Phillips



Art.		L1 mm	L2 mm
3177-00	PH 00	50	150
3177-0	PH 0	50	150
3177-1	PH 1	50	150

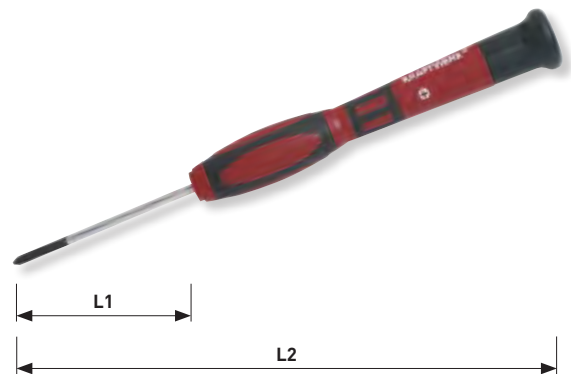

Precision screwdriver for Pozidriv screws

Destornillador de precisión para tornillos Pozidriv

Chave de precisão Pozidriv



Art.		L1 mm	L2 mm
3178-0	PZ 0	50	150
3178-1	PZ 1	50	150

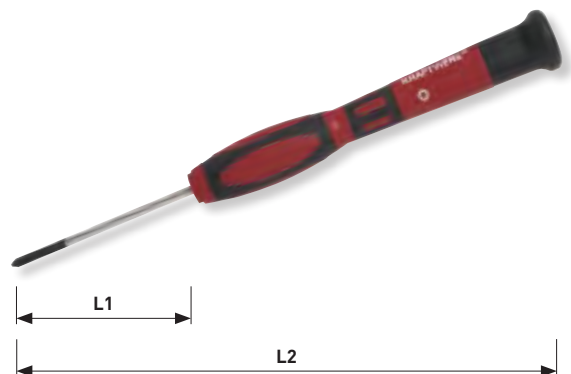



Precision screwdriver for TX screws

Destornillador de precisión para tornillos TX

Chave de precisão TX



Art.		 mm	L1 mm	L2 mm
3178-05	T5	1.42	50	150
3178-06	T6	1.7	50	150
3178-07	T7	1.99	50	150
3178-08	T8	2.3	50	150



Precision screwdriver for TX screws

with bore hole at the short tip, for normal TX screws and tamperproof TX screws

Destornillador de precisión para tornillos TX

con punta perforada, para tornillos con y sin punta de seguridad

Chave de precisão TX

com furo na ponta, para parafusos com e sem ponta de segurança



Art.		mm	L1 mm	L2 mm
3178-09	T9	2.5	50	150
3178-10	T10	2.7	50	150
3178-15	T15	3.3	50	150
3178-20	T20	3.8	50	150



Precision screwdriver set

for slotted and Phillips screws

Juego de destornilladores de precisión

para tornillos de ranura y Phillips

Jogo de chaves de precisão

de parafuso fenda e Phillips



- Art. 3177-20 0.45 x 2.0 mm
- Art. 3177-24 0.50 x 2.4 mm
- Art. 3177-30 0.60 x 3.0 mm
- Art. 3177-35 0.65 x 3.5 mm
- Art. 3177-40 0.80 x 4.0 mm



- Art. 3177-00 PH 00
- Art. 3177-0 PH 0
- Art. 3177-1 PH 1

Art.

3177



8
PCS



Precision screwdriver set

for TX screws

Juego de destornilladores de precisión

para tornillos TX

Jogo de chaves de precisão

de parafuso TX



- Art. 3178-05 T5
- Art. 3178-06 T6
- Art. 3178-07 T7
- Art. 3178-08 T8



- Art. 3179-09 T9
- Art. 3179-10 T10
- Art. 3179-15 T15
- Art. 3179-20 T20

Art.

3178



8
PCS



Universal precision bit-driver set

Juego universal de puntas y portapuntas de precisión

Jogo universal de bits de precisão

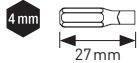

- 5 1.5-2-2.5-3-4 mm
- 3 PH000-PH00-PH0
- 2 PZ00-PZ0
- 4 T4-T5-T6-T7
- 3 T8-T9-T10-T15
- 3 1.5-2-2.5 mm
- 1 4.0 x 95 mm

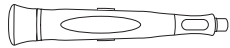

Art.

3180

4 mm

CrV

22
PCS



105 x 70 x 35 mm

Universal precision bit-driver set

with extra long bits

Juego universal de puntas y portapuntas de precisión

con puntas extra largas

Jogo universal de bits de precisão

com bits extra longas

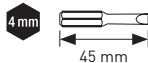

- 5 0.8-1.0-1.5-2.0-3.0 mm
- 4 PH 000-00-0-1
- 3 T3-T4-T5
- 5 T6-T8-T9-T10-T15
- 6 0.7-0.9-1.3-1.5-2.0-2.5 mm

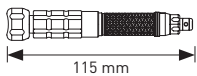

Art.

3181

4 mm

CrV

24
PCS

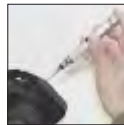

178 x 89 x 35 mm

Electronics-/precision tool set

Practical and compact tool-set for all electronic works (incl. mobile phones, computer). In zipper case.

Juego de herramientas de precisión para electrónica

Gama de herramientas prácticas y compactas para todo tipo de trabajos electrónicos (incluyendo móviles, ordenadores).

En estuche con cremallera.

Conjunto de precisão/electrónica

Conjunto prático e compacto de ferramenta para trabalhos de electrónica (computadores, etc.). Em caixa com fecho.



- 5 1.0-1.5-2.0-2.5-3.0 mm
- 4 PH 000-00-0-1
- 3 T3-T4-T5
- 6 T6-T7-T8-T9-T10-T15
- 3 P2-P5-P6
- 6 0.9-1.3-1.5-2.0-2.5-3.0 mm
- 4 1.6-2.0-2.2-2.3 mm
- 2 No. 0-1
- 2 No. 0-1
- 1 0.8 mm
- 6 2.5-3.0-3.5-4.0-4.5-5.0 mm



Art.

3182

4 mm

51
PCS

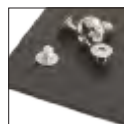

195 x 105 x 35 mm

Offset hexagon key wrench

mat chromed

Llave hexagonal macho acodada

cromada satinada

Chave em "L" sextavada interior

cromada mate

Art.	mm	L mm
3601-1.5	1.5	46.0
3601-2	2.0	52.0
3601-2.5	2.5	58.5
3601-3	3.0	66.0
3601-4	4.0	74.0
3601-5	5.0	84.0
3601-6	6.0	95.0
3601-8	8.0	108.0
3601-10	10.0	121.0



Offset hexagon key wrench set

mat chromed

Juego de llaves hexagonales macho acodadas

cromadas satinadas

Jogo de chaves em "L" sextavada interior

cromadas mate

Art.	mm
3601	1.5-2-2.5-3-4-5-6-8-10



DIN / ISO 2936



Offset hexagon key wrench set

made of stainless steel

Juego de llaves hexagonales macho acodadas

en acero inoxidable

Jogo de chaves em "L" sextavada interior

em aço inoxidável

Art.	mm
3641	1.5-2-2.5-3-4-5-6-8-10



DIN / ISO 2936



Offset ballpoint hexagon key wrench

long, polished and mat chromed

Llave hexagonal macho acodada con bola

larga, pulida y cromada satinado mate

Chave em "L" sextavada interior

com ponta esférica

longa, polida e cromada mate

Art.	 mm	L mm
3602-1.5	1.5	63.5
3602-2	2.0	77.0
3602-2.5	2.5	87.5
3602-3	3.0	93.0
3602-4	4.0	104.0
3602-5	5.0	120.0
3602-6	6.0	141.0
3602-7	7.0	147.0
3602-8	8.0	158.0
3602-10	10.0	180.0



Offset ballpoint hexagon key wrench set

long, polished and mat chromed

Juego de llaves hexagonales macho acodadas con bola

largas, pulidas y cromadas satinado mate

Jogo de chaves em "L" sextavada interior com ponta esférica

longas, polidas e cromadas mate

Art.	 mm
3602	1.5-2-2.5-3-4-5-6-7-8-10



DIN / ISO 2936



Offset ballpoint hexagon key wrench set

long, made of stainless steel

Juego de llaves hexagonales macho acodadas con bola

largas, en acero inoxidable

Jogo de chaves em "L" sextavada interior com ponta esférica

longas, em aço inoxidável



inox 9 PCS

DIN / ISO 2936



Art.	mm
3642	1.5-2-2.5-3-4-5-6-8-10

Offset ballpoint hexagon key wrench

extra long, polished and mat chromed

Llave hexagonal macho acodada con bola

extra larga, pulida y cromada satinado mate

Chave em "L" sextavada interior com ponta esférica

extra longa, polida e cromada mate



CrV XXL



Art.	mm	L mm
3604-1.5	1.5	91.5
3604-2	2.0	102.0
3604-2.5	2.5	114.5
3604-3	3.0	129.0
3604-4	4.0	144.0
3604-5	5.0	165.0
3604-6	6.0	186.0
3604-7	7.0	197.0
3604-8	8.0	208.0
3604-10	10.0	234.0
3606-12	12.0	260.0
3606-14	14.0	294.0
3606-17	17.0	337.0
3606-19	19.0	360.0

DIN / ISO 2936

Offset ballpoint hexagon key wrench set
extra long, polished and mat chromed

Juego de llaves hexagonales macho acodadas con bola

extra largas, pulidas y cromadas satinado mate

Jogo de chaves em "L" sextavada interior com ponta esférica

extra longas, polidas e cromadas mate



DIN / ISO 2936



Art.	mm
3604	1.5-2-2.5-3-4-5-6-7-8-10

Offset ballpoint hexagon key wrench case
extra long, mat chromed

Estuche de llaves hexagonales macho acodadas con bola

extra largas, cromadas satinado mate

Mala de chaves em "L" sextavada interior com ponta esférica

extra longas, cromadas mate



DIN / ISO 2936



360 x 185 x 52 mm

Art.	mm
3606	3-4-5-6-7-8-10-12-14-17

Inch offset ballpoint hexagon key wrench
extra long, polished and mat chromed

Llave hexagonal macho acodada con bola pulgada

extra larga, pulida y cromada satinado mate

Chave em "L" sextavada interior com ponta esférica polegada

extra longa, polida e cromada mate

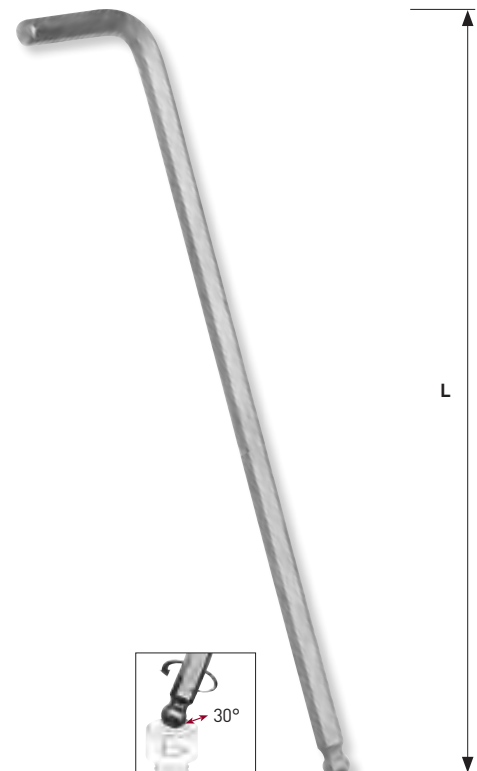

Art.	inch	L mm
3603-1/16	1/16"	92
3603-5/64	5/64"	100
3603-3/32	3/32"	114
3603-1/8	1/8"	130
3603-5/32	5/32"	142
3603-3/16	3/16"	165
3603-1/4	1/4"	185
3603-5/16	5/16"	208
3603-3/8	3/8"	235

Inch offset ballpoint hexagon key wrench set
extra long, polished and mat chromed

Juego de llaves hexagonales macho acodadas con bola pulgadas

extra largas, pulidas y cromadas satinado mate

Jogo de chaves em "L" sextavada interior com ponta esférica polegadas

extra longas, polidas e cromadas mate

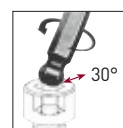

Art.	 inch
3603	1/16"-5/64"-3/32"-1/8"-5/32" 3/16"-1/4"-5/16"-3/8"

Offset key wrench for TX screws
mat chromed

Llave macho acodada para tornillos TX

cromada satinado mate

Chave em "L" TX

cromada mate



Art.		 mm	L mm
3605-10	T10	2.7	50
3605-15	T15	3.3	55
3605-20	T20	3.8	60
3605-25	T25	4.4	68
3605-27	T27	5.0	75
3605-30	T30	5.5	85
3605-40	T40	6.6	95
3605-45	T45	7.82	110
3605-50	T50	8.83	120



Offset key wrench set for TX screws
mat chromed

Juego de llaves macho acodadas para tornillos TX

cromadas satinado mate

Jogo de chaves em "L" TX

cromadas mate

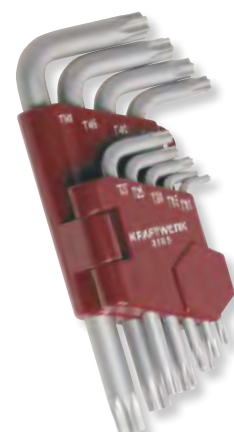



Art.	
3605	T10-T15-T20-T25-T27 T30-T40-T45-T50

Offset key wrench for TX screws
extra long, polished and mat chromed

Llave macho acodada para tornillos TX
extra larga, pulida y cromada satinado mate

Chave em "L" TX
extra longa, polida e cromada mate

Art.		 mm	L mm
3607-10	T10	2.7	93
3607-15	T15	3.3	104
3607-20	T20	3.8	116
3607-25	T25	4.4	131
3607-27	T27	5.0	145
3607-30	T30	5.5	166
3607-40	T40	6.6	187
3607-45	T45	7.82	209
3607-50	T50	8.83	235



S2
quality

XXL

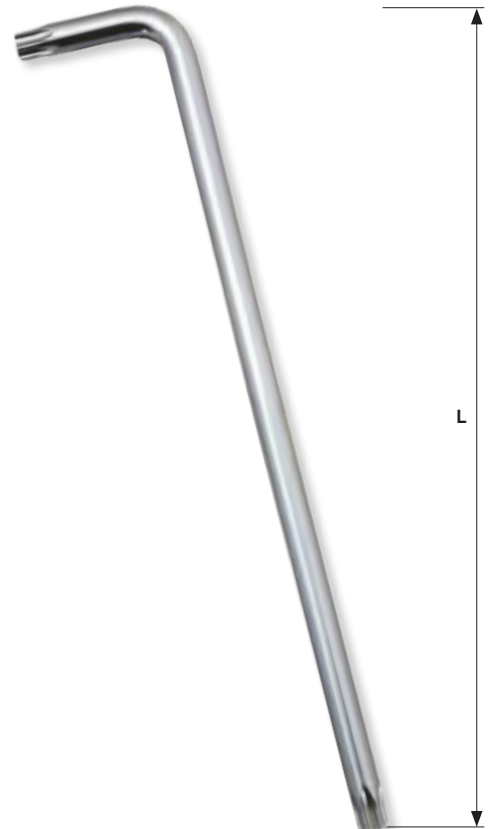

Offset key wrench set for TX screws
extra long, polished and mat chromed

Juego de llaves macho acodadas para tornillos TX

extra largas, pulidas y cromadas satinado mate

Jogo de chaves em "L" TX
extra longas, polidas e cromadas mate

Art.	
3607	T10-T15-T20-T25-T27 T30-T40-T45-T50



S2
quality

XXL **9**
PCS



Offset ballpoint key wrench for TX screws



long, polished and mat chromed

Llave macho acodada con bola para tornillos TX

larga, pulida y cromada satinado mate

Chave em "L" TX com ponta esférica

longa, polida e cromada mate

Art.		 mm	L mm
3608-10	T10	2.7	87
3608-15	T15	3.3	92
3608-20	T20	3.8	96
3608-25	T25	4.4	102
3608-27	T27	5.0	110
3608-30	T30	5.5	118
3608-40	T40	6.6	130
3608-45	T45	7.82	137
3608-50	T50	8.83	160



S2
quality

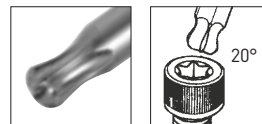
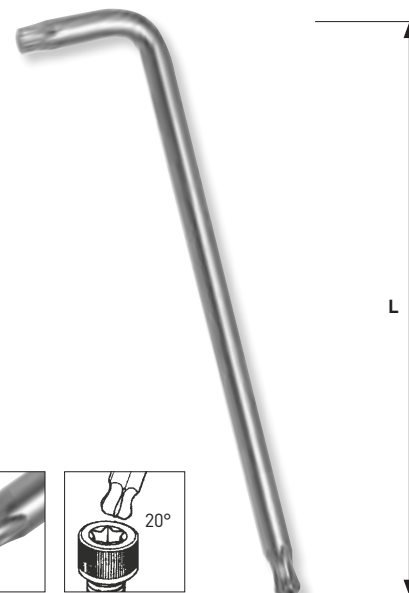

Offset ballpoint key wrench set for TX screws

long, polished and mat chromed

Juego de llaves macho acodadas con bola para tornillos TX

largas, pulidas y cromadas satinado mate

Jogo de chaves em "L" TX com ponta esférica

longas, polidas e cromadas mate

Art.	
3608	T10-T15-T20-T25-T27 T30-T40-T45-T50



S2
quality

9
PCS

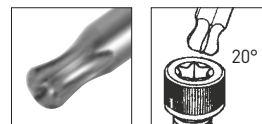

Offset key wrench for TX screws



with bore hole at the tip, for normal TX screws and tamperproof TX screws **extra long**, polished and mat chromed

Llave macho acodada para tornillos TX

con punta perforada, para tornillos TX con y sin punta de seguridad **extra larga**, pulida y cromada satinado mate

Chave em "L" TX

com furo na ponta, para parafusos com e sem ponta de segurança **extra longa**, polida e cromada mate

Art.		 mm	L mm
3609-10	T10	2.7	93
3609-15	T15	3.3	104
3609-20	T20	3.8	116
3609-25	T25	4.4	131
3609-27	T27	5.0	145
3609-30	T30	5.5	166
3609-40	T40	6.6	187
3609-45	T45	7.82	209
3609-50	T50	8.83	235

Offset key wrench set for TX screws

with bore hole at the tip, for normal TX screws and tamperproof TX screws **extra long**, polished and mat chromed

Juego de llaves macho acodadas para tornillos TX

con punta perforada, para tornillos TX con y sin punta de seguridad **extra largas**, pulidas y cromadas satinado mate

Jogo de chaves em "L" TX

com furo na ponta, para parafusos com e sem ponta de segurança **extra longas**, polidas e cromadas mate

Art.	
3609	T10-T15-T20-T25-T27 T30-T40-T45-T50

Offset key wrench set for TX screws

with bore hole at the tip, for normal TX screws and tamperproof TX screws **extra short**, polished and mat chromed

Juego de llaves macho acodadas para tornillos TX

con punta perforada, para tornillos TX con y sin punta de seguridad **extra cortas**, pulidas y cromadas satinado mate

Jogo de chaves em "L" TX

com furo na ponta, para parafusos com e sem ponta de segurança **extra curtas**, polidas e cromadas mate

Art.	
3609S	T10-T15-T20-T25-T27-T30-T40

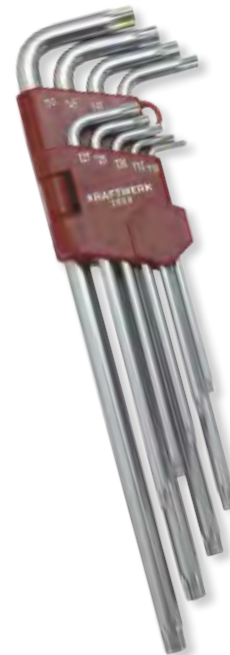

Offset key wrench set for TX screws

with bore hole at the tip, for normal TX screws and tamperproof TX screws **long**, made of **stainless steel**

Juego de llaves macho acodadas para tornillos TX
con punta perforada, para tornillos TX con y sin punta de seguridad **largas**, en acero **inoxidable**

Jogo de chaves em "L" TX

com furo na ponta, para parafusos com e sem ponta de segurança **longas**, em aço **inoxidável**



Art.	
3645	T10-T15-T20-T25-T27-T30-T40-T45-T50

Hexagon T-handle wrench

2 hexagon male ends and 1 ballpoint hexagon male end

Llave en T hexagonal

con 2 extremidades macho hexagonales y 1 extremidad con bola

Chave sextavada interior cabo em "T"

2 pontas macho hexagonal, 1 ponta esférica



Art.	 mm	L 1 mm	L 2 mm
2593-02	2.0	65	126
2593-025	2.5	65	126
2593-03	3.0	65	126
2593-04	4.0	90	180
2593-05	5.0	90	180
2593-06	6.0	105	210
2593-07	7.0	105	210
2593-08	8.0	125	250
2593-10	10.0	145	300

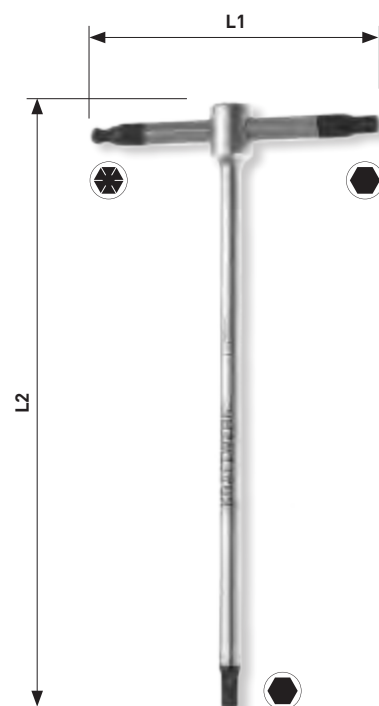

Double joint hexagonal key set
Juego de llaves macho doble articuladas
Jogo de chaves sextavados interior dupla articulação



Art.	
3625	3-4-5-6-8-10 mm

Double joint TX key set
Juego de llaves TX doble articuladas
Jogo de chaves TX dupla articulação



Art.	
3626	T20-T25-T27-T30-T40-T45-T50

Double joint XZN spline key set
Juego de llaves XZN doble articuladas
Jogo de chaves XZN dupla articulação



Art.	
3627	M4-M5-M6-M8-M10

Hexagon T-handle wrench case

2 hexagon male ends and 1 ballpoint hexagon male end

Estuche de llaves en T hexagonal

con 2 extremidades macho hexagonales y 1 extremidad con bola

Mala de chaves sextavada interior cabo em "T"

2 pontas macho hexagonal, 1 ponta esférica

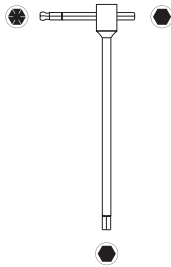
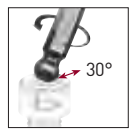

Art. 2593-02	2.0 mm
Art. 2593-025	2.5 mm
Art. 2593-03	3.0 mm
Art. 2593-04	4.0 mm
Art. 2593-05	5.0 mm
Art. 2593-06	6.0 mm
Art. 2593-07	7.0 mm
Art. 2593-08	8.0 mm
Art. 2593-10	10.0 mm

Art.

4900-35K



9
PCS

COMPLETO



421 x 200 x 68 mm

T-handle wrench for TX screws

2 TX male ends and 1 tamper TX male end

Llave en T para tornillos TX

con 2 extremidades macho TX y 1 extremidad TX de seguridad

Chave TX cabo em "T"

2 pontas macho TX, 1 ponta TX com furo

Art.	mm	mm	L 1 mm	L 2 mm
2594-10	T10	2.7	65	125
2594-15	T15	3.2	65	125
2594-20	T20	3.8	65	125
2594-25	T25	4.4	90	180
2594-27	T27	4.9	90	180
2594-30	T30	5.5	90	180
2594-40	T40	6.6	105	210
2594-45	T45	7.82	105	210
2594-50	T50	8.83	105	215

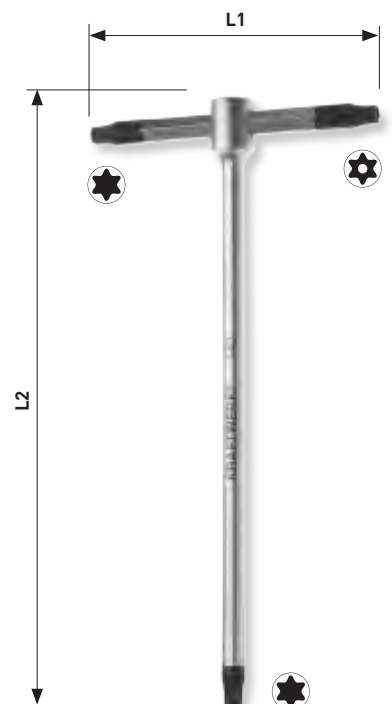

T-handle wrench case for TX screws

2 TX male ends and 1 tamper TX male end

Estuche de llaves en T para tornillos TX

con 2 extremidades macho TX y 1 extremidad TX de seguridad

Mala de chaves TX cabo em "T"

2 pontas macho TX, 1 ponta TX com furo

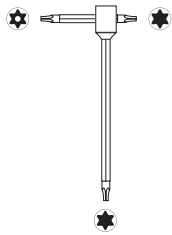

- Art. 2594-10 T10
- Art. 2594-15 T15
- Art. 2594-20 T20
- Art. 2594-25 T25
- Art. 2594-27 T27
- Art. 2594-30 T30
- Art. 2594-40 T40
- Art. 2594-45 T45
- Art. 2594-50 T50

Art.
4900-36K

Foldable hexagon key wrench set

with ergonomic holder

Juego llaves hexagonal macho

en navaja ergonómica

Jogo desdobrável chaves sextavada

interior em suporte ergonómico

Art.	
3623	mm 1.5-2-2.5-3-4-5-6-8

Foldable TX key wrench set

with ergonomic holder

Juego llaves macho para tornillos TX

en navaja ergonómica

Jogo desdobrável chaves TX

em suporte ergonómico

Art.	
3624	T9-T10-T15-T20-T25-T27-T30-T40



9
PCS



421 x 200 x 68 mm

COMPLETO



8
PCS



115 x 40 x 40 mm



8
PCS



115 x 40 x 40 mm



5
PCS

10
PCS

25
PCS

50
PCS



5 pcs./pzs./pcs. 10 pcs./pzs./pcs. 25 pcs./pzs./pcs. 50 pcs./pzs./pcs.

Bit for slotted screws
Punta para tornillos de ranura
Bit de fenda



C6.3
DIN 3126
ISO 1173

DIN 3127
ISO 2351

5 PCS	 mm	 mm
2721-5	0.5	4.0
2722-5	0.6	4.5
2723-5	0.8	5.5
2724-5	1.0	6.0
2725-5	1.2	6.5
2726-5	1.6	8.0

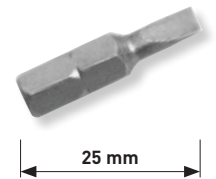

Bit for Phillips screws
Punta para tornillos Phillips
Bit Phillips



C6.3
DIN 3126
ISO 1173

DIN 3128
ISO 8764

5 PCS	10 PCS	50 PCS	
2705-5			PH 0
2701-5	2701-10	2701-50	PH 1
2702-5	2702-10	2702-50	PH 2
2703-5	2703-10		PH 3
2704-5			PH 4

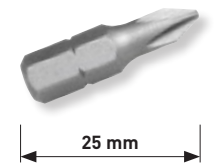

Bit for Pozidriv screws
Punta para tornillos Pozidriv
Bit Pozidriv



C6.3
DIN 3126
ISO 1173

DIN 3128
ISO 8764

5 PCS	10 PCS	50 PCS	
2711-5	2711-10	2711-50	PZ 1
2712-5	2712-10	2712-50	PZ 2
2713-5	2713-10	2713-50	PZ 3
2714-5			PZ 4



Bit for TX screws
Punta para tornillos TX
Bit TX



C6.3
DIN 3126
ISO 1173



5 PCS	10 PCS	50 PCS		 mm
2730-5			T8	2.3
2731-5	2731-10		T10	2.7
2732-5	2732-10	2732-50	T15	3.3
2733-5	2733-10	2733-50	T20	3.8
2734-5	2734-10	2734-50	T25	4.4
2737-5	2737-10		T27	5.0
2735-5	2735-10	2735-50	T30	5.5
2736-5	2736-10	2736-50	T40	6.6
2738-5			T45	7.82
2739-5			T50	8.83

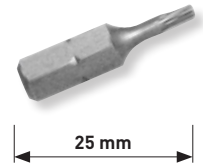

Bit for TX screws

with bore hole at the tip, for normal TX screws and tamperproof TX screws

Punta para tornillos TX

con punta perforada, para tornillos con y sin punta de seguridad

Bit TX

com furo, para parafusos TX com e sem ponta de segurança



C6.3
DIN 3126
ISO 1173



5 PCS		 mm
2749-5	T8	2.3
2751-5	T10	2.7
2752-5	T15	3.3
2753-5	T20	3.8
2754-5	T25	4.4
2755-5	T27	5.0
2756-5	T30	5.5
2757-5	T40	6.6

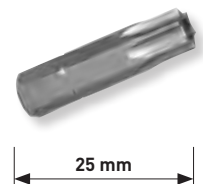

Bit for hexagon socket screws

Punta para tornillos allen

Bit sextavado interior



C6.3
DIN 3126
ISO 1173

DIN 7426
ISO 3109

5	10	mm
2741-5	2741-10	3.0
2742-5	2742-10	4.0
2743-5	2743-10	5.0
2744-5	2744-10	6.0
2745-5		7.0
2746-5		8.0

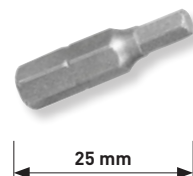

Bit for hexagon socket screws

with bore hole at the tip, for normal screws and tamperproof screws

Punta para tornillos allen

con punta perforada, para tornillos con y sin punta de seguridad

Bit sextavado interior

com furo, para parafusos com e sem ponta de segurança



C6.3
DIN 3126
ISO 1173

5	mm
2676-5	2.0
2677-5	2.5
2678-5	3.0
2679-5	4.0
2680-5	5.0
2681-5	6.0



Bit for inch hexagon socket screws

with bore hole at the tip, for normal screws and tamperproof screws

Punta para tornillos allen en pulgadas

con punta perforada, para tornillos con y sin punta de seguridad

Bit sextavado interior polegado

com furo em ponta, para parafusos com e sem ponta de segurança



C6.3
DIN 3126
ISO 1173

5	inch
2683-5	5/32"
2684-5	9/64"
2685-5	1/8"
2686-5	7/64"
2687-5	3/32"
2688-5	5/64"

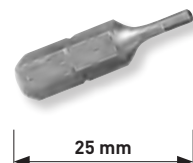

Bit for Torq screws
Punta para tornillos Torq
Bit Torq

1/4"
C6.3
DIN 3126
ISO 1173



5 PCS	
2661-5	No. 6
2662-5	No. 8
2663-5	No. 10

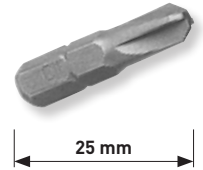

Bit for Tri-Wing screws
Punta para tornillos Tri-Wing
Bit Tri-Wing

1/4"
C6.3
DIN 3126
ISO 1173



5 PCS	
2671-5	No. 1
2672-5	No. 2
2673-5	No. 3
2674-5	No. 4



Bit for Spanner screws
Punta para tornillos Spanner
Bit Spanner

1/4"
C6.3
DIN 3126
ISO 1173



5 PCS	
2665-5	No. 4
2667-5	No. 6
2668-5	No. 8
2669-5	No. 10

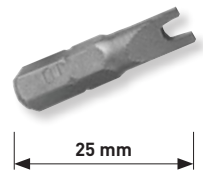

Bit for Robertson square screws
Punta para tornillos Robertson
Bit Robertson

1/4"
C6.3
DIN 3126
ISO 1173



5 PCS	
2689-5	R1
2696-5	R2

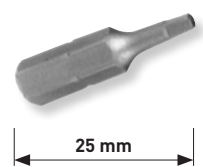

Adapter bit for sockets
Punta-adaptador para vasos
Bit adaptador para chaves

1/4"
C6.3
DIN 3126
ISO 1173



5 PCS		
2770-5	1/4"	1/4"



Bit for slotted screws

of stainless steel

Punta para tornillos de ranura

en acero inoxidable

Bit de fenda

em aço inoxidável





C6.3
DIN 3126
ISO 1173



DIN 3127
ISO 2351

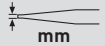

Art.	 mm	 mm
29240	0.8	4.0
29255	0.9	5.5
29265	1.2	6.5
29270	1.6	7.0



Bit for Phillips screws

of stainless steel

Punta para tornillos Phillips

en acero inoxidable

Bit Phillips

em aço inoxidável



C6.3
DIN 3126
ISO 1173



DIN 3128
ISO 8764



Art.	
29000	PH 0
29010	PH 1
29020	PH 2
29030	PH 3

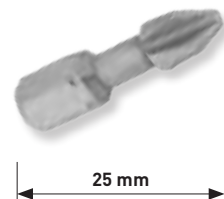

Bit for Pozidriv screws

of stainless steel

Punta para tornillos Pozidriv

en acero inoxidable

Bit Pozidriv

em aço inoxidável



C6.3
DIN 3126
ISO 1173



DIN 3128
ISO 8764



Art.	
29100	PZ 0
29110	PZ 1
29120	PZ 2
29130	PZ 3



Bit for TX screws

of stainless steel

Punta para tornillos TX

en acero inoxidable

Bit TX

em aço inoxidável



C6.3
DIN 3126
ISO 1173

Art.		mm
29310	T10	2.7
29315	T15	3.3
29320	T20	3.8
29325	T25	4.4
29327	T27	5.0
29330	T30	5.5
29340	T40	6.6



Bit for hexagon socket screws

of stainless steel

Punta para tornillos allen

en acero inoxidable

Bit sextavado interior

em aço inoxidável



C6.3
DIN 3126
ISO 1173

DIN 7426
ISO 3109

Art.	mm
29425	2.5
29430	3.0
29440	4.0
29450	5.0
29460	6.0

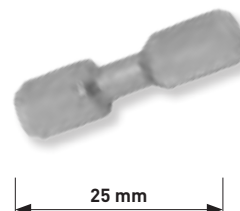

INOX-tools – to avoid external rust

Herramientas en acero inoxidable para evitar el óxido externo

Ferramentas aço **INOX** para evitar ferrugem externa

Bit for slotted screws
Punta para tornillos de ranura
Bit de fenda



E6.3
 DIN 3126
 ISO 1173

DIN 3127
 ISO 2351

5 PCS		
2821-5	0.5	4.0
2822-5	0.6	4.5
2823-5	0.8	5.5
2824-5	1.0	6.0
2825-5	1.2	6.5
2826-5	1.6	8.0

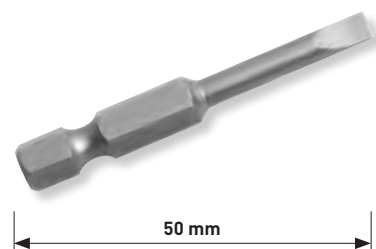

Bit for Phillips screws
Punta para tornillos Phillips
Bit Phillips



E6.3
 DIN 3126
 ISO 1173

DIN 3128
 ISO 8764

5 PCS	10 PCS	25 PCS	
2801-5	2801-10		PH 1
2802-5	2802-10	2802-25	PH 2
2803-5			PH 3
2804-5			PH 4

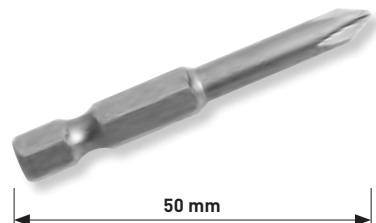

Bit for Pozidriv screws
Punta para tornillos Pozidriv
Bit Pozidriv



E6.3
 DIN 3126
 ISO 1173

DIN 3128
 ISO 8764

5 PCS	10 PCS	25 PCS	
2811-5	2811-10		PZ 1
2812-5	2812-10	2812-25	PZ 2
2813-5			PZ 3
2814-5			PZ 4

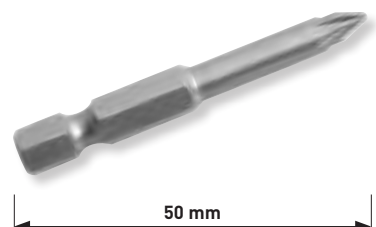

Bit for TX screws
Punta para tornillos TX
Bit TX



E6.3
DIN 3126
ISO 1173



5 PCS	10 PCS		
2831-5		T10	2.7
2832-5	2832-10	T15	3.3
2833-5	2833-10	T20	3.8
2834-5	2834-10	T25	4.4
2837-5		T27	5.0
2835-5	2835-10	T30	5.5
2836-5		T40	6.6

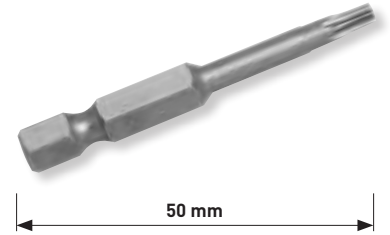

Bit for TX screws
Punta para tornillos TX
Bit TX



E6.3
DIN 3126
ISO 1173



10 PCS		
2861	T10	2.7
2862	T15	3.3
2863	T20	3.8
2864	T25	4.4
2865	T27	5.0
2866	T30	5.5
2867	T40	6.6

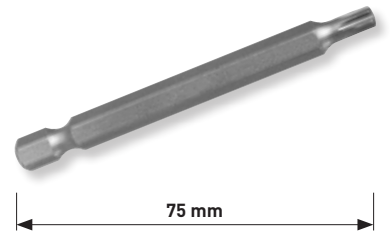

Bit for hexagon socket screws
Punta para tornillos allen
Bit sextavado interior



E6.3
DIN 3126
ISO 1173



5 PCS		mm
2841-5		3
2842-5		4
2843-5		5
2844-5		6
2845-5		7
2846-5		8

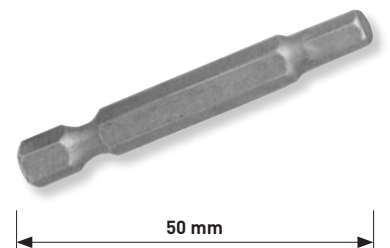

Bit for Robertson square screws
Punta para tornillos Robertson
Bit Robertson

5 PCS	
2690-5	R1
2697-5	R2



E6.3
DIN 3126
ISO 1173



Adapter bit for sockets
Punta-adaptador para vasos
Bit adaptador para chaves

5 PCS		
2850-5	1/4"	1/4"



E6.3
DIN 3126
ISO 1173



Adapter bit for sockets
Punta-adaptador para vasos
Bit adaptador para chaves

5 PCS		
2860-5	1/4"	3/8"



E6.3
DIN 3126
ISO 1173



Magnetic nut setter
Punta stecker magnética
Chave para porcas magnética

Art.	mm
3784-07	7
3784-08	8
3784-10	10
3784-13	13



E6.3
DIN 3126
ISO 1173



Screw tight tool for setting screws
Adaptador tornillo
Chave para parafusos de rosca

Art.	Ø
3784-M6	M6
3784-M8	M8
3784-M10	M10
3784-M12	M12



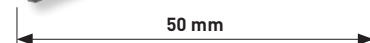

E6.3
DIN 3126
ISO 1173



Bit for slotted screws

Punta para tornillos de ranura

Bit de fenda

Art.	 mm	 mm
302055	0.8	5.5
302065	1.0	6.5
302080	1.2	8.0
302100	1.6	10.0
302120	2.0	12.0



DIN 3126-D8
ISO 1173



DIN 3127
ISO 2351



Bit for Phillips screws

Punta para tornillos Phillips

Bit Phillips

Art.	
303001	PH 1
303002	PH 2
303003	PH 3
303004	PH 4



DIN 3126-D8
ISO 1173



DIN 3128
ISO 8764

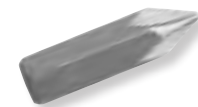

Bit for Phillips screws

Punta para tornillos Phillips

Bit Phillips

Art.	
313001	PH 1
313002	PH 2
313003	PH 3



DIN 3126-D8
ISO 1173



DIN 3128
ISO 8764

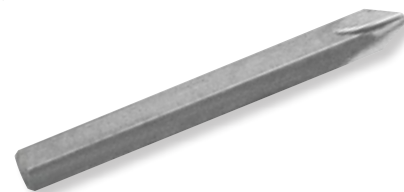

Bit for Pozidriv screws

Punta para tornillos Pozidriv

Bit Pozidriv

Art.	
304001	PZ 1
304002	PZ 2
304003	PZ 3
304004	PZ 4



DIN 3126-D8
ISO 1173



DIN 3128
ISO 8764

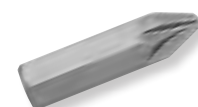

Bit for Pozidriv screws
Punta para tornillos Pozidriv
Bit Pozidriv



DIN 3126-D8
ISO 1173



DIN 3128
ISO 8764

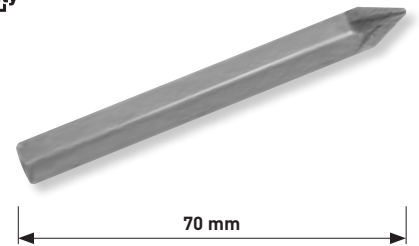

Art.	
314001	PZ 1
314002	PZ 2

Bit for TX screws
Punta para tornillos TX
Bit TX



DIN 3126-D8
ISO 1173

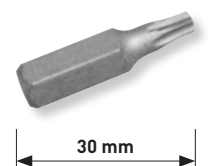

Art.		 mm
305010	T10	2.7
305015	T15	3.3
305020	T20	3.8
305025	T25	4.4
305027	T27	5.0
305030	T30	5.5
305040	T40	6.6
305045	T45	7.82
305047	T47	8.1
305050	T50	8.83
305055	T55	11.22
305060	T60	13.25
305070	T70	15.51
305080	T80	17.54
305090	T90	19.92
305100	T100	22.13

Bit for TX screws

Punta para tornillos TX

Bit TX



DIN 3126-D8
ISO 1173



Art.		mm
315015	T15	3.3
315020	T20	3.8
315025	T25	4.4
315027	T27	5.0
315030	T30	5.5
315040	T40	6.6
315045	T45	7.82
315050	T50	8.83
315055	T55	11.22
315060	T60	13.25
315070	T70	15.51
315080	T80	17.54
315090	T90	19.92
315100	T100	22.13

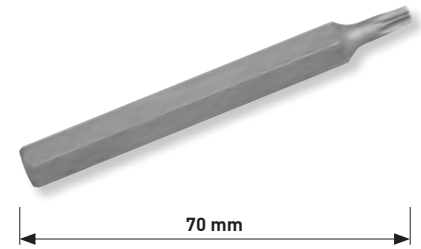

Bit for TX screws

with bore hole at the tip, for normal TX screws and tamperproof TX screws

Punta para tornillos TX

con punta perforada, para tornillos con y sin punta de seguridad

Bit TX

com furo, para parafusos TX com e sem ponta de segurança



DIN 3126-D8
ISO 1173



Art.		mm
305310	T10	2.7
305315	T15	3.3
305320	T20	3.8
305325	T25	4.4
305327	T27	5.0
305330	T30	5.5
305340	T40	6.6
305345	T45	7.82
305350	T50	8.83
305355	T55	11.22
305360	T60	13.25
305370	T70	15.51

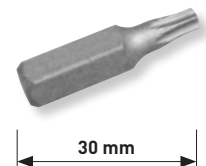

Bit for TX screws

with bore hole at the tip, for normal TX screws and tamperproof TX screws

Punta para tornillos TX

con punta perforada, para tornillos con y sin punta de seguridad

Bit TX

com furo, para parafusos TX com e sem ponta de segurança



DIN 3126-D8
ISO 1173

Art.		 mm
315320	T20	3.8
315325	T25	4.4
315327	T27	5.0
315330	T30	5.5
315340	T40	6.6
315345	T45	7.82
315350	T50	8.83
315355	T55	11.22
315360	T60	13.25

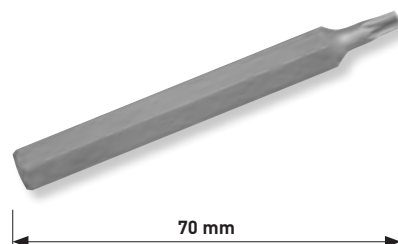

Bit for hexagon socket screws

Punta para tornillos allen

Bit sextavado interior



DIN 3126-D8
ISO 1173

DIN 7426
ISO 3109

Art.	 mm
306003	3
306004	4
306005	5
306006	6
306007	7
306008	8
306010	10
306012	12
306014	14

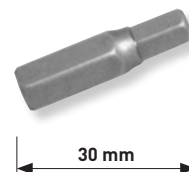

Bit for hexagon socket screws

Punta para tornillos allen

Bit sextavado interior



DIN 3126-D8
ISO 1173

DIN 7426
ISO 3109

Art.	 mm
316004	4
316005	5
316006	6
316007	7
316008	8
316010	10
316012	12

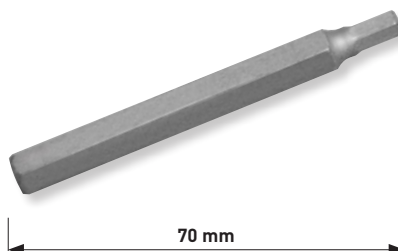

Bit for inch hexagon socket screws
Punta para tornillos allen en pulgadas
Bit sextavado interior polegada

5/16"



S2
quality

inch

DIN 3126-D8
ISO 1173

Art.	inch
306501	1/8"
306502	5/32"
306503	3/16"
306504	7/32"
306505	1/4"
306507	5/16"
306509	3/8"

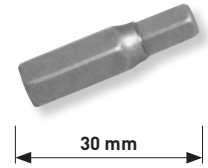

Bit for XZN spline screws
Punta con perfil XZN
Bit para parafusos estriados XZN

5/16"



S2
quality

DIN 3126-D8
ISO 1173

Art.	XZN
348005	M5
348006	M6
348008	M8
348010	M10
348012	M12

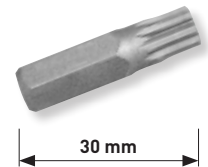

Bit for XZN spline screws
Punta con perfil XZN
Bit para parafusos estriados XZN

5/16"



S2
quality

DIN 3126-D8
ISO 1173

Art.	XZN
349005	M5
349006	M6
349008	M8
349010	M10
349012	M12

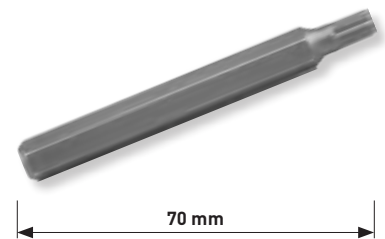

Impact bit for slotted screws
Punta impacto para tornillos de ranura
Bit impacto de fenda

5/16"



DIN 3126-D8
ISO 1173

Art.	mm	mm
2035F06	1.0	6
2035F08	1.2	8
2035F10	1.6	10
2035F12	2.0	12

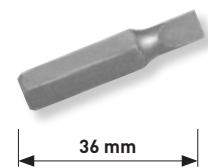

Impact bit for Phillips screws
Punta impacto para tornillos Phillips
Bit impacto Phillips

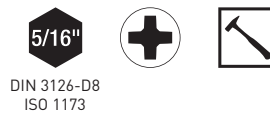

Art.	+
2035PH1	PH 1
2035PH2	PH 2
2035PH3	PH 3
2035PH4	PH 4

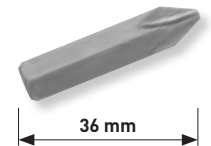

Impact bit for TX screws
Punta impacto para tornillos TX
Bit impacto TX



Art.	*
2035T30	T30
2035T40	T40
2035T45	T45
2035T50	T50



Impact adapter bit for sockets
Punta-adaptador de impacto para vasos
Bit impacto adaptador para chave de caixa



Art.	●	■
2035B38	5/16"	3/8"

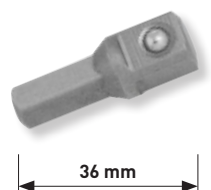

Bit-holder socket
Vaso portapuntas
Chave de caixa porta-bits



Art.	○	○
2760	1/4"	1/4"



Bit-holder socket

Vaso portapuntas

Chave de caixa porta-bits



Art.			L mm
2761	3/8"	1/4"	27
211516	3/8"	5/16"	29
311516	1/2"	5/16"	38



Impact bit-holder socket

Vaso portapuntas impacto

Chave de caixa porta-bits impacto



Art.		
2035A12	1/2"	5/16"

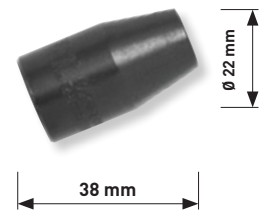

Bit-adapter

Portapunta

Adaptador de bit



CLICKRAFT

Art.		
2694	10mm	1/4"



Magnetic bit-holder

Portapuntas magnético

Suporte magnético para bits



Art.			L mm
2750	1/4"	1/4"	60
2750-1	1/4"	1/4"	60
2764	1/4"	1/4"	142



inox



Adjustable magnetic fixing bit-holder
Portapuntas magnético ajustable
Suporte magnético ajustável para bits

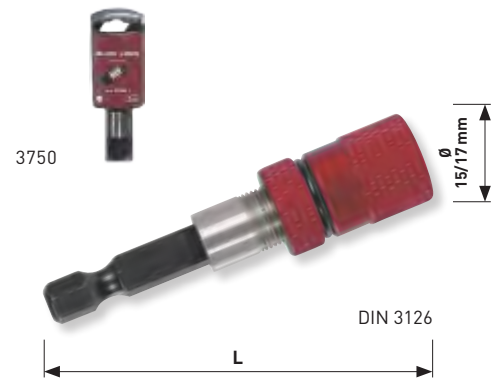

Art.			L mm
3750	1/4"	1/4"	58
3760	5/16"	5/16"	75

Magnetic quick release bit-holder
Portapuntas magnético de extracción rápida
Suporte magnético de bits de encaixe rápido



Art.		
2765	1/4"	1/4"
2765-1	1/4"	1/4"

Magnetic quick release bit-holder
with eject button
Portapuntas magnético de extracción rápida
con botón de expulsión
Adaptador magnético de bits de encaixe rápido
com botão de ejeção



Art.		
3764	1/4"	1/4"
3764-1	1/4"	1/4"

Magnetic quick release bit-holder
Portapuntas magnético de extracción rápida
Suporte magnético de bits de encaixe rápido



E 6.3

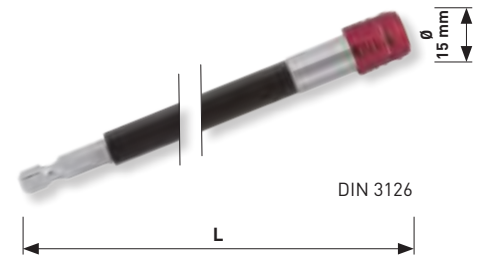

Art.	Hex	Round	L mm
3766	1/4"	1/4"	150
3767	1/4"	1/4"	300
3768	1/4"	1/4"	450
3769	1/4"	1/4"	600

Flexible extension bar for bits
Alargadera flexible para puntas
Extensão flexível para bits



Art.	Hex	Round
107140	1/4"	1/4"

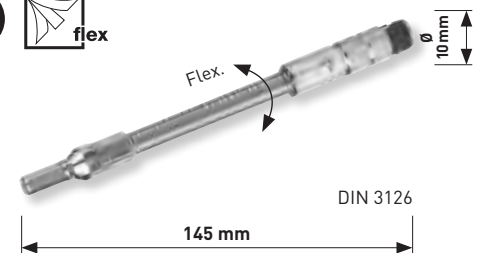

Angle screw attachment
Portapuntas angular
Porta-bits de angulo



max. 15 Nm
max. 400 rpm

Art.	Hex	Round
2768	1/4"	1/4"

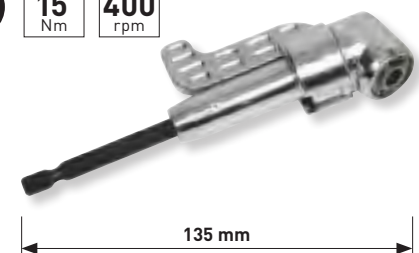

Stubby bit ratcheting driver
Mango carraca para puntas
Punho para bits com roquete
curto



ERGOKRAFT

Art.	Round
4133B	1/4"



Torque bit-screwdriver
Atornillador dinamométrico para puntas
Chave torque para bits

1-4 Nm A +/- 4 %



Art.	○	Nm ←->
2039	1/4"	1-4

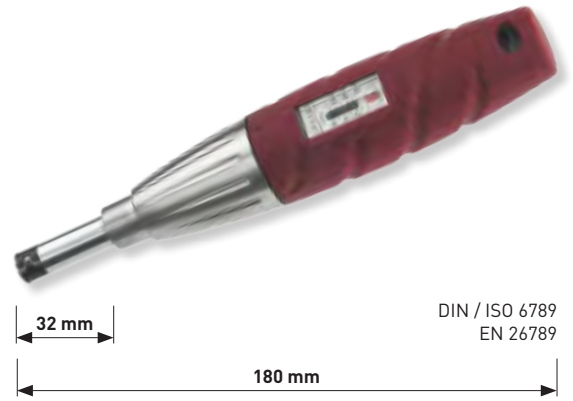

DIN / ISO 6789
 EN 26789

Fine teeth reversible bit ratchet handle
Carraca reversible dentado fino para puntas
Roquete manual reversível de dentes finos para bits



Art.	○
3799	1/4"



Mini reversible bit ratchet handle
Mini carraca reversible para puntas
Mini roquete manual reversível para bits



Art.	○
2700	1/4"



Fine teeth bit ratchet handle

2 reversible 15° offset heads, for direct drive of 1/4" and 5/16" bits

Carraca dentado fino para puntas

reversible de 2 lados, acodada 15°, con adaptación directa de puntas 1/4" y 5/16"

Roquete manual de dentes finos para bits

reversível dos dois lados, cabeça com 15° para adaptação directa dos bits 1/4" e 5/16"



Art.	1/4"	5/16"
4070		

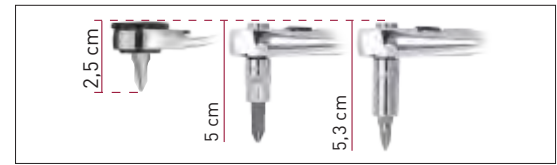
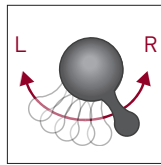
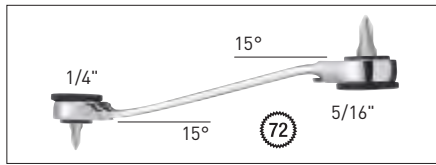

Bit set for TX screws

with bore hole at the tip, for normal TX screws and tamperproof TX screws

Set puntas para tornillos TX

con punta perforada, para tornillos con y sin punta de seguridad

Jogo de bits TX

com furo, para parafusos TX com e sem ponta de segurança



Art.	1/4"	T10-T15-T20-T25-T27-T30-T40	25 mm
2758			

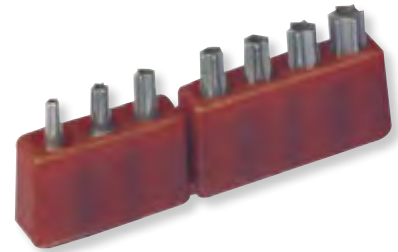

57 x 13 x 28 mm

Round bit box

Caja redonda de puntas

Caixa redonda de bits

- 2 PZ 1-2
- 7 T10-T15-T20-T25-T27-T30-T40
- 4 mm

Art. 2750







Art.	1/4"	25 mm
2780		





Ø 50 x 67 mm



Universal round bit box
Caja redonda universal de puntas
Caixa redonda de bits universais

- 3  4.5-5.5-6.5 mm
- 3  PH 1-2-3
- 2  PZ 1-2
- 2  4-5 mm





 Art. 2750

Art.		
2783	1/4"	25 mm



± Ø 50 x 67 mm

Universal round bit box
Caja redonda universal de puntas
Caixa redonda de bits universais

- 2  4-5.5-6.5 mm
- 2  PH 1-2
- 3  PZ 1-2-3
- 6  T10-T15-T20-T25-T30-T40
- 4  3-4-5-6 mm





 Art. 2750

Art.		
2786	1/4"	25 mm





± Ø 81 x 50 mm

Universal round bit box
Caja redonda universal de puntas
Caixa redonda de bits universais

- 3  4-5.5-6.5 mm
- 2  PH 1-2
- 3  PZ 1-2-3
- 6  T10-T15-T20-T25-T30-T40
- 4  3-4-5-6 mm

 Art. 2750

Art.		
2790	1/4"	50 mm



± Ø 83 x 60 mm

Aluminium bit box







with the double composition of TX and Pozidriv bits

Caja en aluminio de puntas

con composición doble de puntas TX y Pozidriv

Caixa em alumínio de bits

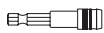

com composição dupla de bits TX e Pozidriv

- 3  4-4.5-5.5 mm
- 3  PH 1-2-3
- 6  2xPZ1 - 2xPZ2 - 2xPZ3
- 12  T10 - T15 - 2xT20 - 2xT25 - 2xT27 - 2xT30 - 2xT40
- 6  T10-T15-T20-T25-T27-T30
- 4  3-4-5-6 mm



Art. 3765 



Art.		
3782-1	1/4"	25 mm



C6.3

DIN 3126
ISO 1173



Alu

 105 x 78 x 34 mm

Bit box

with 6 bits colour promptly distinguishing TX bits and quick release bit-holder

Caja de puntas

con 6 puntas TX de colores para una rápida distinción y portapuntas magnético de extracción rápida

Jogo de bits

com 6 bits TX de cores para fácil reconhecimento da medida e porta bits magnético de encaixe rápido



- 6  T10-T15-T20-T25-T30-T40



  1/4"  1/4"



C6.3

DIN 3126
ISO 1173



 68 x 65 x 20 mm

Art.		
99049	1/4"	25 mm

Bit box





with quick release bit-holder

Caja de puntas

con portapuntas magnético de extracción rápida



Jogo de bits

com porta bits magnético de encaixe rápido

- 6  4-4.5-5.5-6-6.5-8 mm
- 3  PH 1-2-3
- 6  2xPZ1 - 2xPZ2 - 2xPZ3
- 12  2xT10 - 2xT15 - 2xT20 - 2xT25 - 2xT30 - 2xT40
- 4  3-4-5-6 mm



Art. 2765

Art.		
3788	1/4"	25 mm



C6.3
DIN 3126
ISO 1173



101 x 56 x 30 mm

Bit tool set

with slim reversible bit ratchet handle. Especially suitable for bikes.









Juego de puntas

con carraca reversible delgada. Especialmente apropiado para bicicletas.



Jogo de bits

com roquete reversível. Especialmente apropiado para bicicletas.



- 1  5 mm
- 1  PH2
- 1  T20
- 6  2-2.5-3-4-5-6 mm
-  1/4"  1/4"
-  1/4"  1/4"



Art.		
3776	1/4"	25 mm

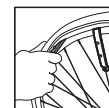

2x

Universal bit box







with quick release bit-holder

Caja de puntas universal

con portapuntas magnético de extracción rápida

Jogo de bits universais

com porta bits magnético de encaixe rápido

- 6  4-4.5-5.5-6-6.5-8 mm
- 3  PH 1-2-3
- 3  PZ 1-2-3
- 6  T10-T15-T20-T25-T30-T40
- 6  T10-T15-T20-T25-T30-T40
- 4  3-4-5-6 mm



Art. 2765

Art.		
3789	1/4"	25 mm



C6.3
DIN 3126
ISO 1173



101 x 56 x 30 mm

Special bit box







with security bits for all common security screws and quick release bit-holder

Caja de puntas específicas



con puntas de seguridad para todos los tornillos de seguridad corrientes y con portapuntas magnético de extracción rápida

Jogo de bits específicos

com bits de segurança para todos os parafusos de segurança comuns e porta bits magnético de encaixe rápido

- 9  T8-T10-T15-T20-T25-T27-T30-T35-T40
- 6  2-2.5-3-4-5-6 mm
- 6  5/64"-3/32"-7/64"-1/8"-9/64"-5/32"
- 3  Nos. 6-8-10
- 4  Nos. 1-2-3-4
- 4  Nos. 4-6-8-10

 Art. 2765

Art.		
3786	1/4"	25 mm

1/4"

S2
quality

33
PCS

C6.3

DIN 3126
ISO 1173



 101 x 56 x 30 mm

Bit box





with stainless steel bits and quick release bit-holder

Caja de puntas



en acero **inoxidable**, con portapuntas magnético de extracción rápida

Jogo de bits

em aço **inoxidável**, com porta bits magnético de encaixe rápido

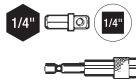
- 3  4-5.5-6.5 mm
- 4  PH1 - 2xPH2 - PH3
- 6  2xPZ1 - 3xPZ2 - PZ3
- 14  2xT10 - 2xT15 - 2xT20 - 2xT25 - 2xT27 - 2xT30 - 2xT40
- 4  3-4-5-6 mm

 Art. 2765

Art.		
3796	1/4"	25 mm

1/4"

inox

33
PCS

C6.3

DIN 3126
ISO 1173



 103 x 56 x 30 mm

Universal bit box







with quick release bit-holder

Caja de puntas universal

con portapuntas magnético de extracción rápida



Jogo de bits universais

com porta bits magnético de encaixe rápido

- 6  4-4.5-5.5-6-6.5-8 mm
- 5  PH1 - 2xPH2 - PH3 - PH4
- 6  2xPZ1 - 2xPZ2 - PZ3 - PZ4
- 30  3xT10 - 3xT15 - 6xT20 - 6xT25 - 6xT30 - 6xT40
- 7  T10-T15-T20-T25-T27-T30-T40
- 6  3-4-5-6-7-8 mm



Art. 2765

Art.		
3787	1/4"	25 mm

1/4"

S2
quality

61
PCS

C6.3

DIN 3126
ISO 1173



101 x 90 x 32 mm

Universal bit box











with quick release bit-holder

Caja de puntas universal

con portapuntas magnético de extracción rápida

Jogo de bits universais

com porta bits magnético de encaixe rápido

- 6  4-4.5-5.5-6-6.5-8 mm
- 4  PH 1-2-3-4
- 4  PZ 1-2-3-4
- 8  T8-T10-T15-T20-T25-T27-T30-T40
- 8  T8-T10-T15-T20-T25-T27-T30-T40
- 6  3-4-5-6-7-8 mm
- 6  2-2.5-3-4-5-6 mm
- 6  5/64"-3/32"-7/64"-1/8"-9/64"-5/32"
- 4  Nos. 1-2-3-4
- 3  Nos. 6-8-10
- 4  Nos. 4-6-8-10



Art. 2765

Art.		
3777	1/4"	25 mm

1/4"

S2
quality

61
PCS

C6.3

DIN 3126
ISO 1173



101 x 90 x 32 mm

Bit box

2-component box with stainless steel bit-holder and magnetic bit-holder with special bit quick release function

Caja de puntas

bimaterial, con portapuntas en acero inoxidable y portapuntas magnético especial de extracción rápida

Jogo de bits

Caixa em bimatéria com porta bits em inox e porta bits especial com libertação rápida

- 4 4-5.5-6-6.5 mm
- 5 PH0 - PH1 - 2xPH2 - PH3
- 4 PZ1 - 2xPZ2 - PZ3
- 11 T10 - 2xT15 - 2xT20 - 2xT25 - T27 - 2xT30 - T40
- 7 T10-T15-T20-T25-T27-T30-T40
- 4 3-4-5-6 mm



Art. 3765

Art. 2750



Art.		
3795	1/4"	25 mm



C6.3

DIN 3126
ISO 1173



129 x 72 x 35 mm

Long bit box

2-component box with 50 mm long bits

Caja de puntas largas

bimaterial, con puntas de largo 50 mm

Jogo de bits longos

Caixa em bimatéria com bits longos 50 mm

- 3 4.5-5.5-6.5 mm
- 2 PH 1-2
- 4 PZ1 - 2xPZ2 - PZ3
- 10 T10 - T15 - 2xT20 - 2xT25 - T27 - 2xT30 - T40
- 4 3-4-5-6 mm



Art.		
3794	1/4"	50 mm



E6.3

DIN 3126
ISO 1173



129 x 72 x 35 mm

Universal bit case

with all current, special and security bits. Universal bit-screwdriver with 2-component handle

Estuche puntas

con todas las puntas habituales, especiales y de seguridad.
Atornillador portapuntas con mango bimaterial

Mala de bits universais

com todos os bits normais e especiais. Chave universal de dois componentes no cabo.

1/4" **1/4"** **138**
C6.3 E6.3 PCS
DIN 3126
ISO 1173

ERGOKRAFT



- 6 4-4.5-5.5-6-6.5-8 mm
- 6 2xPH1 - 2xPH2 - 2xPH3
- 6 2xPZ1 - 2xPZ2 - 2xPZ3
- 28 2xT8 - 2xT10 - 2xT15 - 5xT20 - 6xT25 - 3xT27 - 4xT30 - 4xT40
- 16 2xT8 - 2xT10 - 2xT15 - 2xT20 - 2xT25 - 2xT27 - 2xT30 - 2xT40
- 15 TS10 - 2xTS15 - 2xTS20 - 3xTS25 - 2xTS27 - 3xTS30 - 2xTS40
- 5 3-4-5-6-8 mm
- 3 3-4-5 mm
- 3 Nos. 6-8-10
- 3 Nos. 1-2-3
- 4 Nos. 4-6-8-10
- 2 Nos. 1-2
- 3 M5-M6-M8
- 4 Nos. 1-2-3-4

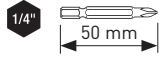

- 3 4-5.5-6.5 mm
- 3 PH 1-2-3
- 3 PZ 1-2-3
- 7 T10-T15-T20-T25-T27-T30-T40
- 2 3-6 mm
- Art. 2750
- Art. 2750



220 x 150 x 45 mm

10 4-5-6-7-8-9-10-11-12-13 mm

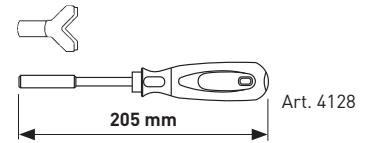

Art.			
2778	1/4"	25 mm	50 mm

Universal bit case

with 2 magnetic bit holders in solid bi-material case. Delivered with reversible ratchet bit-driver with bendable head (straight / pistol shape)







Caja universal de puntas







con 2 portapuntas magnéticos en caja sólida bimatérica. Incluye mango atornillador reversible con carraca (recto/doblado)

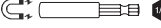

Jogo de bits universais

com 2 porta bits numa caixa sólida em bimatéria. Com chave de bits com roquete reversível

1/4" **1/4"** **S2 quality** **114 PCS**
C6.3 E6.3
DIN 3126
ISO 1173

- 1/4"**  14  **7x4mm - 7x6mm**
21  **7xPH1 - 7xPH2 - 7xPH3**
21  **7xPZ1 - 7xPZ2 - 7xPZ3**
14  **2xT10 - 2xT15 - 2xT20 - 2xT25 - 2xT27 - 2xT30 - 2xT40**
7  **T10-T15-T20-T25-T27-T30-T40**
21  **7x4mm - 7x5mm - 7x6mm**

- 1/4"**  75 mm **3**  **3xPH2**  **1/4"**
3  **3xPZ2**  **1/4"**
7  **T10 - T15 - 3xT20 - T25 - T30**  **1/4"**

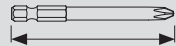
Art.			
99068	1/4"	25 mm	75 mm



204 x 118 x 44 mm

180 mm

TRIBIT bit tool case

with the TRIBIT ratchet handle, reverse function on both sides, 15° offset heads, for the direct drive of bits 1/4" and 5/16" and 1/4" dr. sockets. Universal composition with 53 bits and socket adapter 1/4" drive.

Estuche TRIBIT

con la llave con carraca TRIBIT, reversible de 2 lados, acodada 15°, con adaptación directa de puntas 1/4" y 5/16" y vasos 1/4". Juego con 53 puntas y adaptador vasos 1/4".

Jogo TRIBIT

com roquete TRIBIT, reversível dos dois lados, cabeça com 15° para adaptação directa dos bits 1/4" e 5/16" e chaves 1/4". Jogo composto por 53 bits e adaptador para chaves caixa 1/4".

1/4" **5/16"** **72** **S2 quality** **55 PCS**
C6.3 DIN 3126-D8 ISO 1173
DIN 3126
ISO 1173

- 1/4"** **3**  **4-5.5-6.5 mm** **3**  **8-10-12 mm**
3  **PH 0-1-2** **2**  **PH 3-4**
3  **PZ 0-1-2** **2**  **PZ 3-4**
7  **T8-T10-T15-T20-T25-T27-T30** **5**  **T40-T45-T50-T55-T60**
7  **T8-T10-T15-T20-T25-T27-T30** **5**  **T40-T45-T50-T55-T60**
6  **3-4-5-6-7-8 mm** **3**  **10-12-14 mm**
5/16"  **1/4"** **4**  **M6-M8-M10-M12**

Art.	
4072	1/4" + 5/16"





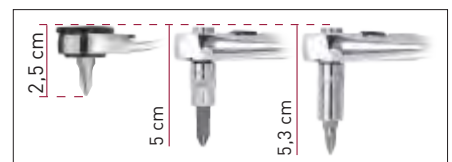
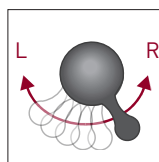
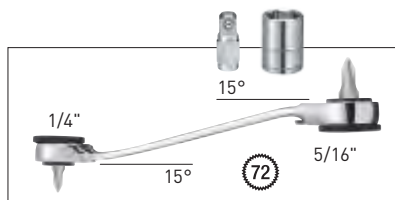









163 x 80 x 35 mm



Special bit- and socket set
for TX, XZN-spline and RIBE-screws

Juego de llaves de vaso y puntas especiales
para tornillos TX, XZN y RIBE

Jogo de chaves de caixa e bits especiais
para parafusos TX, XZN e RIBE

-  3  E6-E7-E8
-  6  E10-E11-E12-E14-E16-E18
-  
-  
-  10  T10-T15-T20-T25-T27-T30-T40-T45-T50-T55
- 5  M4-M6-M8-M10-M12
- 10  M4-M5-M6-M7-M8-M9-M10-M12-M13-M14

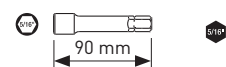

Art.		
3792	5/16"	30 mm







DIN 3126-D8
ISO 1173





221 x 114 x 45 mm

Impact driver set
for easy loosening of blocked or rusted screws and nuts

Estuche atornillador de impacto
para aflojar fácilmente los tornillos y tuercas bloqueados y oxidados

Jogo de impacto
para facilmente desbloquear parafusos e porcas bloqueados

- 4  6-8-10-12 mm
- 4  PH 1-2-3-4
- 4  T30-T40-T45-T50

-  Art. 2035A12
-  Art. 2035B38

Art.		
2035	5/16"	36 mm





DIN 3126-D8
ISO 1173



216 x 102 x 58 mm

Impact driver
for the set 2035

Mango atornillador impacto
para estuche 2035

Punho de impacto
para jogo 2035

Art.		L mm
2035S	1/2"	143

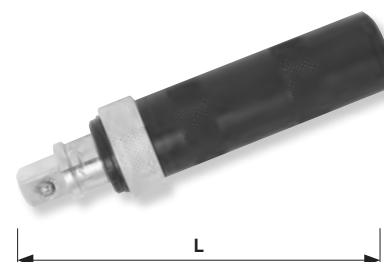

Impact driver set

for easy loosening of blocked or rusted screws and nuts

Estuche atornillador de impacto

para aflojar fácilmente los tornillos y tuercas bloqueados y oxidados

Jogo de impacto

para facilmente desbloquear parafusos e porcas bloqueados

- 4   4  6-8-10-12 mm
- 4  PH 1-2-3-4
- 4  PZ 1-2-3-4
- 4  T30 - 2xT40 - T45
- 5  4-5-6-8-10 mm

- 5/16"    3/8"

Art.	
2036	5/16"

  
DIN 3126-D8
ISO 1173



 221 x 114 x 45 mm

Screw extractor impact screwdriver set

to release rusted and damaged slotted and recessed head screws.



Juego de destornilladores de extractor de golpeo

para aflojar los tornillos de cabeza ranurada y tornillos de estrella oxidados y defectuosos.

Jogo de chaves de parafusos de extractor de impacto

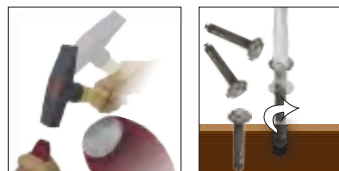
para desbloquear parafusos de fenda e com cabeça com fenda cruzada enferrujados e/ou defeituosos.



Art.			L mm
4149	6.0 x 100 mm	PH2 x 100 mm	195



 L

Screw extractor

Extractor de espárragos

Extratores de parafusos

Art.	No.	<->	∅ mm	L mm
3059-1	1	M3-M6 1/8"-1/4"	2.5	52
3059-2	2	M6-M8 1/4"-5/16"	3.0	57
3059-3	3	M8-M11 5/16"-7/16"	4.0	65
3059-4	4	M11-M14 7/16"-9/16"	6.0	75
3059-5	5	M14-M18 9/16"-3/4"	8.0	80
3059-6	6	M18-M24 3/4"-1"	11.0	98

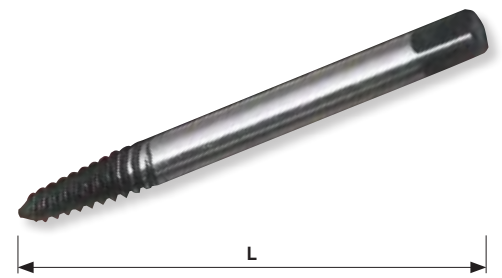

Screw extractor set

Juego extractores de espárragos

Jogo de extratores de parafusos

Art.	Nos.	<->
3059	1-2-3-4-5-6	M3-M24

6
PCS



144 x 143 x 25 mm

Bolt twister

Extractor de tornillos

Extractor de parafusos

Art.	∅ mm	∅	L mm
3057-02	2	3/8"	60
3057-03	3	3/8"	60
3057-04	4	3/8"	60
3057-05	5	3/8"	60
3057-06	6	3/8"	60
3057-07	7	3/8"	60
3057-08	8	1/2"	78
3057-10	10	1/2"	78
3057-12	12	1/2"	78
3057-14	14	1/2"	78
3057-16	16	1/2"	78

3/8" 1/2" NiCrMo

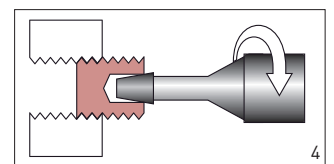
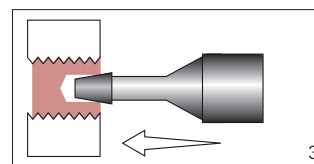
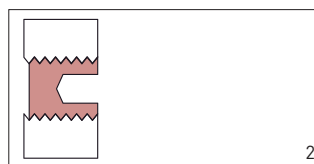
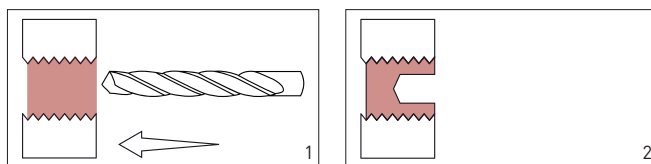

Bolt twister set

Juego de extractores de tornillos

Jogo de extractores de parafusos

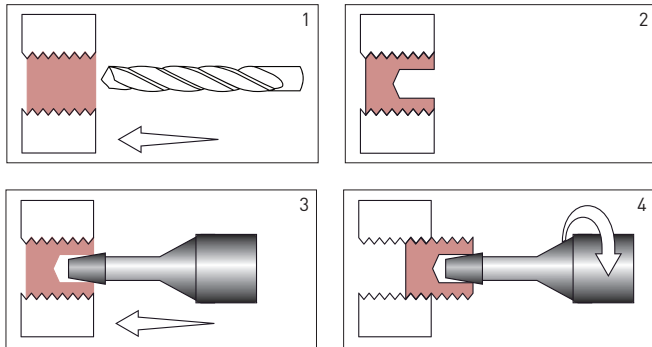

Art.	Ø mm	Ø mm
3057	2-3-4-5-6-7	8-10-12-14-16

3/8" 1/2" NiCrMo 11 PCS



232 x 167 x 54 mm

Stud puller

Extractor a rodillo

Extractor de pernos

Art.	Ø	Ø	Ø	L mm
3060-06	6 mm - 1/4"	1/2"	21 mm	60
3060-08	8 mm - 5/16"	1/2"	21 mm	60
3060-10	10 mm - 3/8"	1/2"	21 mm	69
3060-12	12 mm - 7/16"	1/2"	21 mm	69

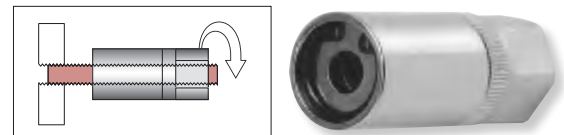
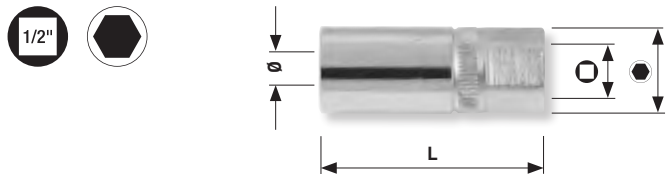

Stud puller set

Juego de extractores a rodillo

Jogo de extractores de pernos

1/2" 4 PCS



221 x 123 x 45 mm

Art.	Ø
3060	6-8-10-12 mm 1/4" - 5/16" - 3/8" - 7/16"

Twist socket
Extractor de tuercas
Extractor de porcas

Art.	Ø mm	Ø
3058-10	10	1/2"
3058-11	11	1/2"
3058-12	12	1/2"
3058-13	13	1/2"
3058-14	14	1/2"
3058-15	15	1/2"
3058-16	16	1/2"
3058-17	17	1/2"
3058-19	19	1/2"

1/2" NiCrMo

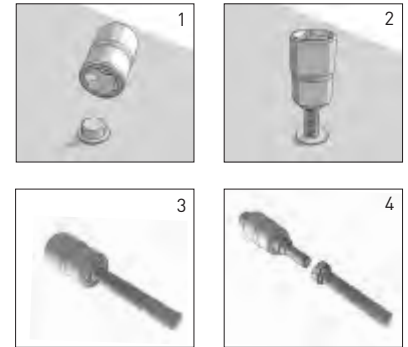

Twist socket set
Juego de extractores de tuerca
Jogo de extractores de porcas

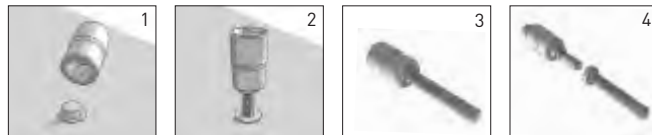

Art.	Ø mm
3058	10-11-12-13-14-15-16-17-19

1/2" NiCrMo 10 PCS



164 x 120 x 52 mm

Cotter pin puller
Garfio extractor
Gancho angular

Art.	L1 mm	L2 mm
4322-1	127	230

ERGOKRAFT



Scraper awl

Lezna

Furador redondo

Art.	L1 mm	L2 mm
4322-2	120	225



Hose plucker

Garfio extractor de mangueras

Gancho

Art.	L1 mm	L2 mm
4322-3	80	185

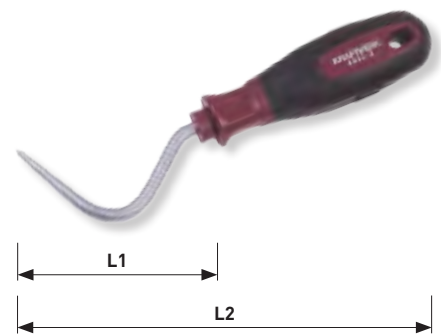

Mini full hook

Mini gancho

Mini gancho

Art.	L1 mm	L2 mm
4322-4	50	130

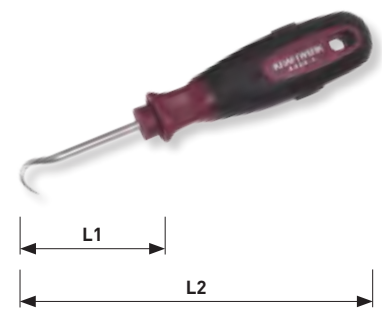

Mini straight pick

Mini punzón

Mini furador redondo

Art.	L1 mm	L2 mm
4322-5	60	140

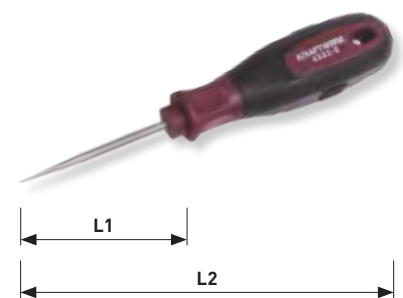

Mini hook

Mini gancho 90°

Mini gancho 90°

Art.	L1 mm	L2 mm
4322-6	50	130

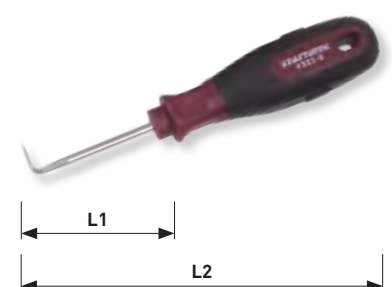

Mini small angle hook
Mini gancho acodado
Mini gancho angular

Art.	L1 mm	L2 mm
4322-7	60	140

ERGOKRAFT



Remover and pick set
Juego de ganzúas y picos
Conjunto de ganchos e furadores



Art.
4322

7
PCS

ERGOKRAFT



Flexible telescope magnetic pick up
Dedo magnético telescópico flexible
Pesca peças flexível magnético telescópico

Art.	Ø mm	L mm
3197	11	135 - 570



1500 g

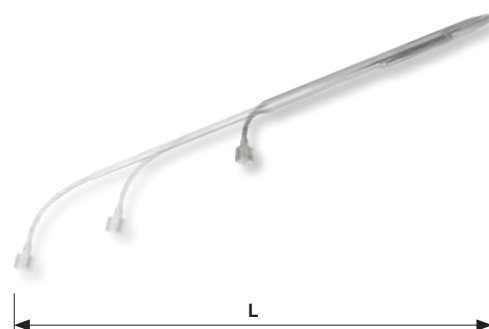

4-in-1 Magnetic pick-up set
Juego dedos magnéticos 4 en 1
Kit 4-em-1 pesca peças magnético e espelho

Art.	L mm
3188	130 - 630



1500 g

4
PCS



Telescope magnetic pick up
Dedo magnético telescópico
Pesca peças telescópico magnético

Art.	Ø mm	L mm
3196	11	130 - 630



2000 g



Heavy duty flexible magnetic pick-up
Dedo magnético flexible
Pesca peças flexível magnético

Art.	Ø mm	L mm
3195	18	520



3500 g

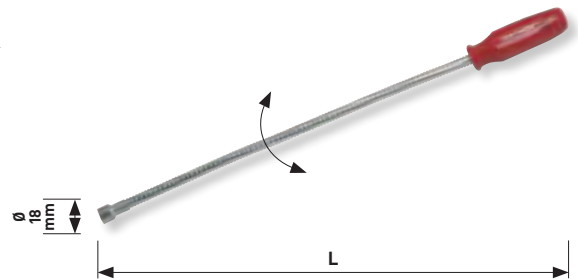

Flexible pick-up claw with magnet
Garra magnética flexible
Garra flexível com íman

Art.	L mm
3198	700



800 g

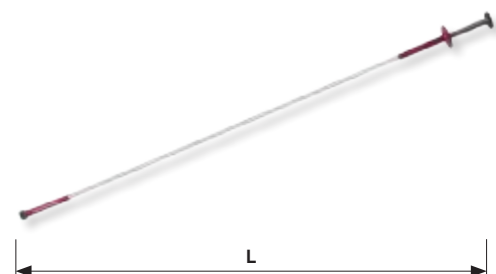

Magnetic pick-up, LED and mirror-set
Estuche dedos magnéticos/LED/set espejos
Kit pesca peças, espelho, LED

Art.	L mm
3190	176 - 660

5
PCS

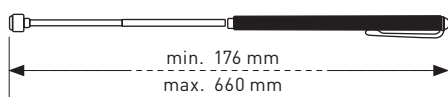

245 x 117 x 49 mm





Pliers collection *Colección de alicates* Coleção de alicates



3C-SoftGrip



TitaniumFinish



TouchGrip

HIGHTECH 3C

The industrial pliers line

made of special steel, forged and oil hardened, with inductive hardened cutting edges, with free of glare and reflexion titanium finish. Maximum grip and ergonomics grace to "soft-grip" handles of the latest **3-component** technology, with impact protection.

La línea de alicates industriales

fabricados en acero especial, forjado, templado al aceite, con cortes de precisión endurecidos por inducción y con acabado titanium antirreflejo.

*Máximo agarre y ergonomía gracias a mangos "soft-grip" de última tecnología de **3 componentes**, con protección contra impactos.*

A linha de alicates industriais

feitos em aço especial, forjados e endurecidos, com cortes de precisão endurecidos por indução, com acabamento em titânio sem reflexo. Máxima aderência e ergonomia, graças ao punhos "soft-grip" lida com a mais recente tecnologia **3-componente**, com proteção contra impacto.

ERGOKRAFT

Ergonomic 2 components grip

for maximal grip comfort and optimal power transmission, made of chrome-vanadium steel, chromed, mirror polished.

Mango bimaterial ergonómico

para una utilización más confortable y fuerza óptima, en acero cromo-vanadio, cromado, pulido brillante.

Punhos ergonómicos de 2 componentes

para máximo conforto e poder de transmissão brilhante, em aço cromo-vanadium, cromado, polida.

Combination pliers
Alicate universal
Alicate universal

Art.	K Ø mm	C Ø mm	H Ø mm	L mm
4271-165	10	4.0	2.0	165
4271-180	12	5.2	2.2	180
4271-205	13	5.9	2.5	205

Ergonomic combination pliers 45° - heavy duty

- With 45° angle head for muscle and tendon gentle working grace to the straight posture of the hand at gripping, turning and pulling.
- Higher torque by the leverage effect of the angle.

Alicate universal ergonómico 45° - para industria

- Con cabeza angular 45°, respeta los músculos y tendones gracias a la postura recta de la mano al agarrar, girar y tirar.
- Mayor fuerza por el efecto del ángulo.

Alicate universal ergonómica 45° - trabalho pesado

- Com cabeça angular de 45° para um trabalho ergonómico graças a posição direita da mão quando aperta, vira e puxa.
- Elevado torque devido ao efeito de alavanca.



Art.	K Ø mm	C Ø mm	H Ø mm	L mm
4201-200P	13	2.5	5.9	200

Combination pliers
Alicate universal
Alicate universal

Art.	L mm
3281-160	160
3281-180	180
3281-200	200

HIGHTECH 3C



220 N/mm²

1800 N/mm²



HIGHTECH



220 N/mm²

1800 N/mm²



ERGOKRAFT



Side cutting nippers
Alicate de corte diagonal
Alicate de corte diagonal

Art.	K Ø mm	C Ø mm	H Ø mm	L mm
4272-145	8	5	1.7	145
4272-160	11	6	2.0	160
4272-180	13	7	2.5	180



HIGHTECH 3C



Electrician side cutting nippers
Alicate de corte diagonal para electricista
Alicate de corte diagonal de electricista

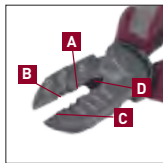

- A** crimping
prensar
prensagem
- B** stripping
pelar
descaramento
1.5-2.5 mm²
- C** cutting
cortar
corde
- D** bending
doblar
dobra

Art.	K Ø mm	C Ø mm	H Ø mm	L mm
4272-190	4	2	1	190



HIGHTECH 3C

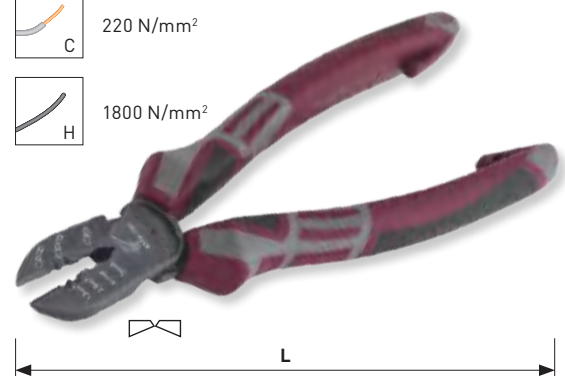

Side cutting nippers
Alicate de corte diagonal
Alicate de corte diagonal

Art.	L mm
3282-140	140
3282-160	160

ERGOKRAFT



High leverage side cutting nippers
Alicate de corte diagonal extra fuerte
Alicate de corte diagonal de alto desempenho

Art.	M Ø mm	H Ø mm	P Ø mm	L mm
4273-180	3.7	2.6	2.2	180
4273-200	4.0	2.8	2.5	200

Heavy duty lever side cutting nippers
 Extremely easy cutting with little strain grace to the ideal transmission of force with double-hinged design.
Alicate de corte diagonal extra fuerte con efecto palanca
Corte extremadamente fácil con poco esfuerzo gracias a la transmisión óptima de fuerza por el diseño de doble articulación.
Alicate de corte diagonal de alto desempenho
 Corte extremamente fácil com pouco esforço devido a transmissão ideal de força com o design de articulação dupla.



Art.	M Ø mm	H Ø mm	P Ø mm	L mm
4274-200	4.5	3.5	3.0	200

High leverage side cutting nippers
Alicate de corte diagonal extra fuerte
Alicate de corte lateral

Art.	L mm
3283-180	180

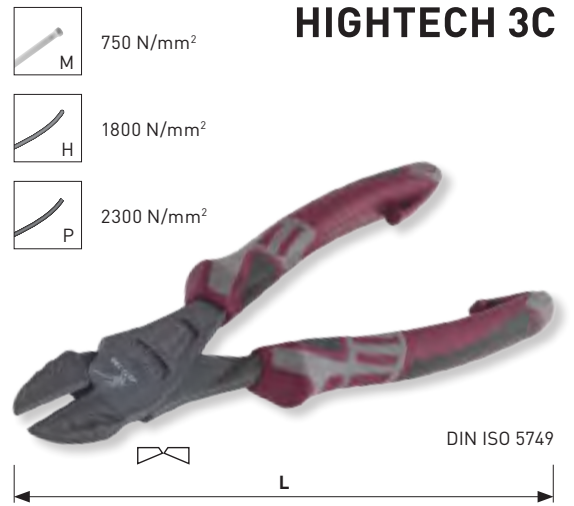

Heavy duty lever end cutting nippers

Extremely easy cutting with little strain grace to the ideal transmission of force with double-hinged design.

Alicate de corte frontal extra fuerte con efecto palanca

Corte extremadamente fácil con poco esfuerzo gracias a la transmisión óptima de fuerza por el diseño de doble articulación.

Alicate de corte frontal de alto desempenho

Corte extremamente fácil com pouco esforço devido a transmissão ideal de força com o design de articulação dupla.



Art.	C Ø mm	M Ø mm	H Ø mm	L mm
4214-200	4.5	4.0	3.5	200

End cutting nippers

Alicate de corte frontal

Alicate de corte frontal

Art.	L mm
3284-160	160

HIGHTECH



750 N/mm²



1800 N/mm²



2300 N/mm²



+ 150% POWER



ERGOKRAFT



Long nose pliers

Alicate de manipulación

Alicate de ponta semi-redonda

Art.	C Ø mm	H Ø mm	L mm
4275-170	2.5	1.6	170
4275-205	3.9	2.2	205



Multifunction long nose pliers 45°

- With 45° angle head for muscle and tendon gentle working grace to the straight posture of the hand at gripping, turning and pulling.

- Higher torque by the leverage effect of the angle.

Alicate de manipulación multifuncional 45°

- Con cabeza angular 45°, respeta los músculos y tendones gracias a la postura recta de la mano al agarrar, girar y tirar.

- Mayor fuerza por el efecto del ángulo.

Alicate de ponta semi-redonda multi-função 45°

- Com cabeça angular de 45° para um trabalho ergonómico graças a posição direita da mão quando aperta, vira e puxa.

- Elevado torque devido ao efeito de alavanca.

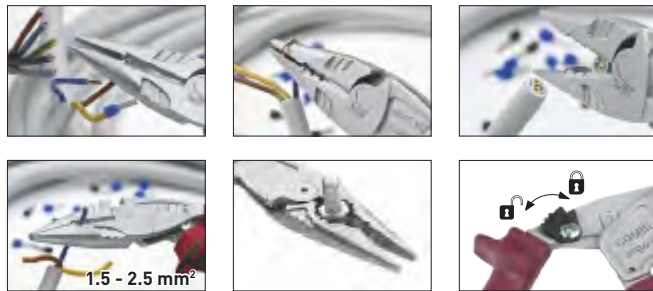

Art.	K mm ²	K Ø mm	C Ø mm	H Ø mm	L mm
4205-200P	1.5-2.5	13	5.9	2.5	200



220 N/mm²

1800 N/mm²

HIGHTECH



Long nose pliers
Alicate de manipulación
Alicate de punta semi-redonda

Art.	L mm
3285-160	160
3285-200	200



Long nose pliers, angled 45°
Alicate de manipulación, angular 45°
Alicate de punta semi-redonda, angular 45°

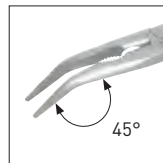

Art.	C Ø mm	H Ø mm	L mm
4276-205	3.9	2.2	205



Long nose pliers, angled 45°
Alicate de manipulación, angular 45°
Alicate de punta semi-redonda, angular 45°

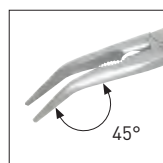

Art.	L mm
3286-200	200

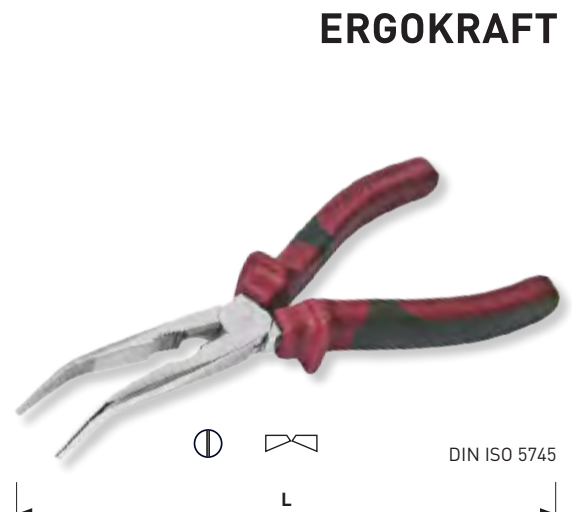

Special double X pliers set

with 2 extra long nose pliers, straight and 45°.
Double-X-system for an optimal power transmission.

Juego alicates especiales doble X

con 2 alicates de manipulación extra largos, recto y 45°.
Sistema doble-X- para una óptima transmisión de fuerza.

Conjunto de alicates especiais duplo X

com 2 alicates de pontas extra longas, direitas e a 45°.
Sistema Duplo-X para uma excelente transmissão de força.

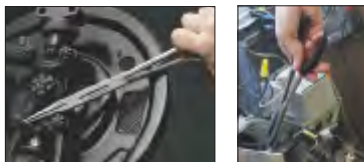

Art.	L mm
30001	330



Flat nose pliers

Alicate con bocas planas

Alicate de pontas planas

Art.	L mm
4277-160	160

HIGHTECH 3C



Flat nose pliers

Alicate con bocas planas

Alicate de pontas planas

Art.	L mm
3287-160	160

ERGOKRAFT



Round nose pliers

Alicate con bocas redondas

Alicate de pontas redondas

Art.	L mm
4278-160	160

HIGHTECH 3C

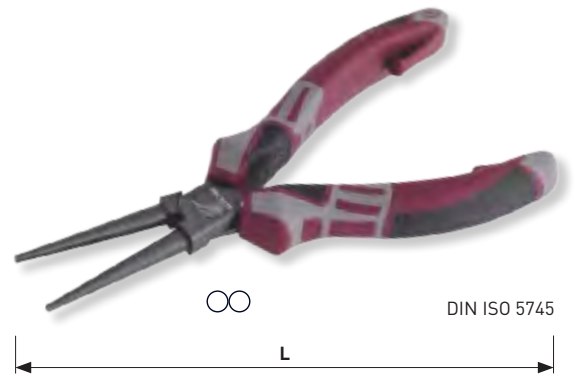

Round nose pliers

Alicate con bocas redondas

Alicate de pontas redondas

Art.	L mm
3288-160	160

ERGOKRAFT



Wire stripping pliers

Alicate pelacables

Alicate descarnador de fio

Art.	K mm ²	K Ø mm	L mm
4279-160	0.5 - 10	5	160

HIGHTECH 3C



Multifunction wire stripping pliers
Alicate pelacables multifuncional
Alicate descarnador de fio multifunções



Art.	K mm ²	K Ø mm	C Ø mm	H Ø mm	L mm
4279-180	5 - 16	11	6	2	180



220 N/mm²



1800 N/mm²

HIGHTECH 3C



Wire stripping pliers
Alicate pelacables
Alicate descarnador de fio

Art.	K mm ²	K Ø	L mm
3289-160	0.5 - 10	5	160

ERGOKRAFT

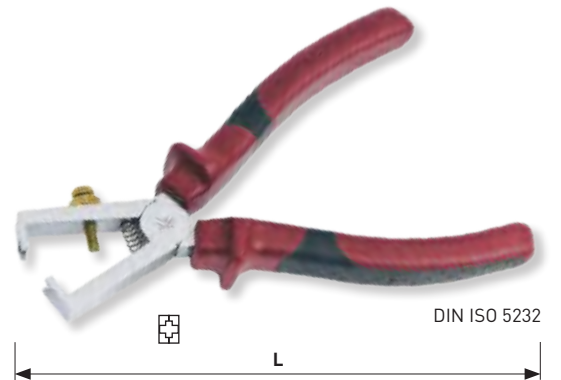

Pliers set
Juego de alicates
Jogo de alicates



DIN ISO 5746

180 mm

Art. 3281-180



DIN ISO 5749

160 mm

Art. 3282-160



DIN ISO 5745

200 mm

Art. 3285-200



DIN ISO 8976

250 mm

Art. 2221-250

Art.
3292

4
PCS

ERGOKRAFT



Isolated combination pliers 1000 V
Alicata universal aislado 1000 V
Alicata universal aislado 1000 V

Art.	K Ø mm	C Ø mm	H Ø mm	L mm
4211-180	12	5.2	2.2	180

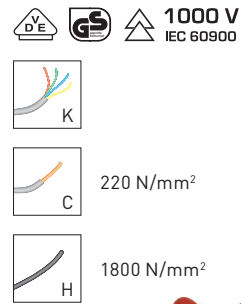

HIGHTECH

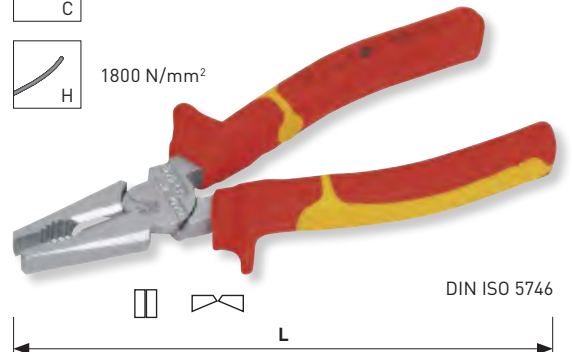

Isolated combination pliers 1000 V
Alicata universal aislado 1000 V
Alicata universal aislado 1000 V

Art.	L mm
3281-180V	180



ERGOKRAFT



Isolated side cutting nippers 1000 V
Alicata de corte diagonal aislado 1000 V
Alicata de corte diagonal aislado 1000 V

Art.	K Ø mm	C Ø mm	H Ø mm	L mm
4212-160	11	6.0	2.0	160
4212-180	13	7.0	2.5	180

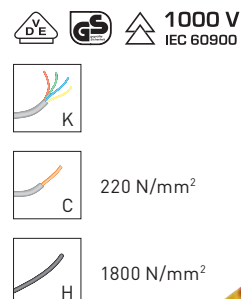

HIGHTECH

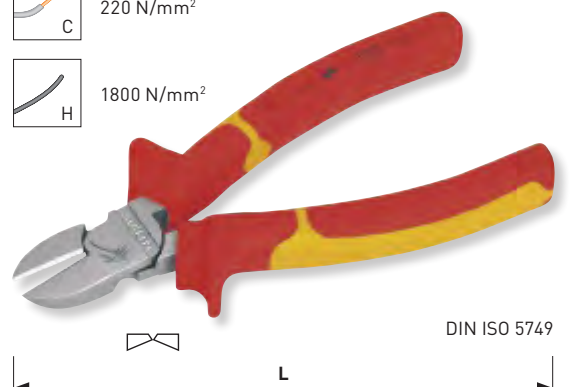

Isolated side cutting nippers 1000 V
Alicate de corte diagonal aislado 1000 V
Alicate de corte diagonal isolado 1000 V



ERGOKRAFT



DIN ISO 5749



Art.	L mm
3282-160V	160

Isolated high leverage side cutting nippers 1000 V
Alicate de corte diagonal extra fuerte aislado 1000 V
Alicate de corte diagonal de alta multiplicação isolado 1000 V



HIGHTECH



1800 N/mm²



2300 N/mm²



DIN ISO 5749



Art.	H Ø mm	P Ø mm	L mm
4213-180	2.6	2.2	180
4213-200	2.8	2.5	200

Isolated long nose pliers 1000 V
Alicate de manipulación aislado 1000 V
Alicate de ponta semi-redonda isolado 1000 V



HIGHTECH



220 N/mm²



1800 N/mm²



DIN ISO 5745



Art.	C Ø mm	H Ø mm	L mm
4215-205	3.9	2.2	205

Isolated long nose pliers 1000 V
Alicate de manipulación aislado 1000 V
Alicate de ponta semi-redonda isolado 1000 V



ERGOKRAFT

Art.	L mm
3285-200V	200



Isolated long nose pliers, angled 45° 1000 V
Alicate de manipulación, angular 45°, aislado 1000 V
Alicate de ponta semi-redonda, angular 45°, isolado 1000 V

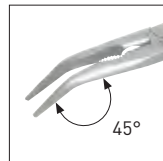

Art.	C Ø mm	H Ø mm	L mm
4216-205	3.9	2.2	205



HIGHTECH

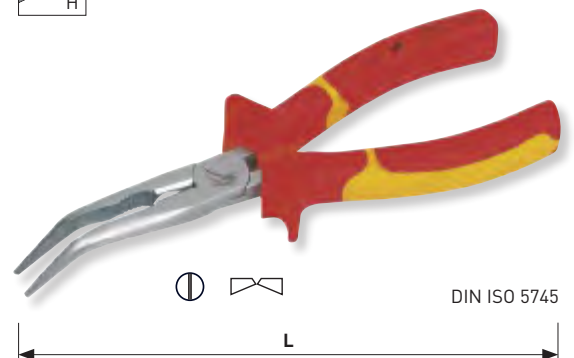
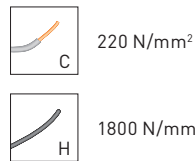

Isolated wire stripping pliers 1000 V
Alicate pelacables aislado 1000 V
Alicate descarnador de fio isolado 1000 V



HIGHTECH

Art.	K mm²	K Ø mm	L mm
4219-160	0.5 - 10	5	160

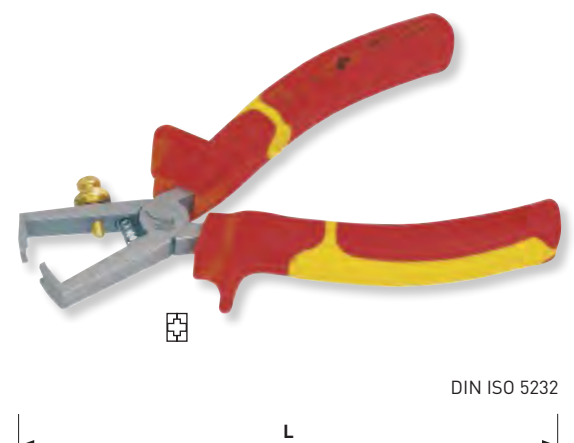

Isolated wire stripping pliers 1000 V
Alicate pelacables aislado 1000 V
Alicate descarnador de fio isolado 1000 V



ERGOKRAFT

Art.	K mm ²	K Ø mm	L mm
3289-160V	0.5 - 10	5	160

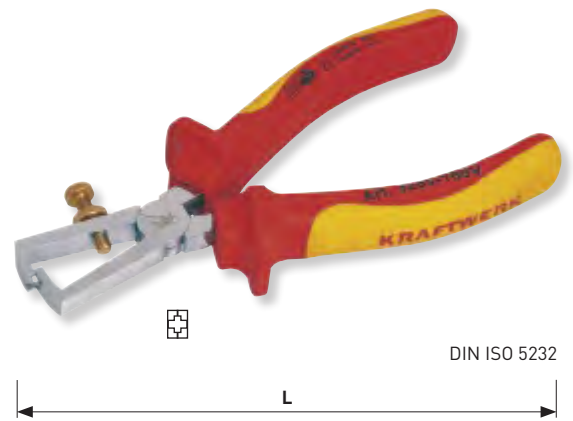

Isolated cable-cutter 1000 V
Alicate cortacables aislado 1000 V
Alicate corta-cabo isolado 1000 V



HIGHTECH

Art.	K mm ² Al + Cu	K Ø Al + Cu	L Ø mm
4210-160	50	16	160
4210-210	70	25	210



Isolated water pump pliers 1000 V
Tenaza para bomba de agua aislada 1000 V
Alicate bomba de água isolado 1000 V



HIGHTECH

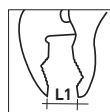

Art.	L1 mm	L2 mm
4220-250	50	250



Electronic linesman pliers
Alicates universal electrónica
Alicates universal electrónico

Art.	L mm
2236	110

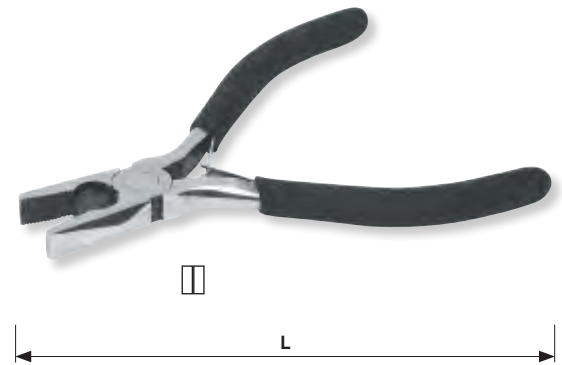

Electronic side cutting nippers
Alicates electrónica de corte diagonal
Alicates electrónico de corte diagonal

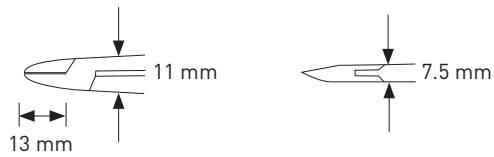

Art.	C Ø mm	H Ø mm	P Ø mm	L mm
4235-115	1.2	0.6	0.4	115



220 N/mm²

1800 N/mm²

2300 N/mm²

HIGHTECH



Electronic round head side cutting nippers
Alicates electrónica de corte diagonal, rasante
Alicates electrónico de corte diagonal, cabeza redonda

Art.	L mm
2234	110



Electronic triangle head side cutting nippers

Alicate electrónica de corte diagonal, semirasante

Alicate electrónico de corte diagonal, cabeza triángulo

Art.	L mm
2235	105

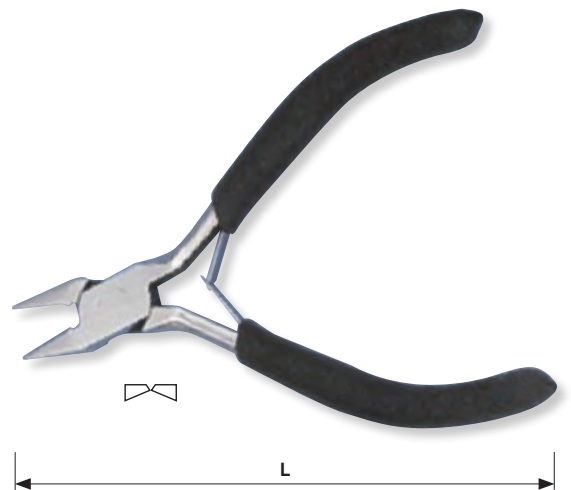

Electronic end cutting nippers

Alicate electrónica de corte frontal

Alicate electrónico de corte lateral

Art.	L mm
2237	100



Electronic plain long nose pliers

Alicate electrónica de manipulación, bocas lisas

Alicate eletrônico de pontas semi-redondas suaves

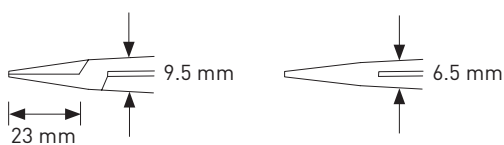

Art.	L mm
4233-115	115



HIGHTECH



Electronic long nose pliers

*Alicate electrónica de manipulación,
bocas largas*

Alicate electrónico de puntas semi-redondas

Art.	L mm
2231	120



Electronic extra long nose pliers

*Alicate electrónica de manipulación,
bocas extra-largas*

**Alicate electrónico de puntas semi-redondas
longas**

Art.	L mm
2232	150

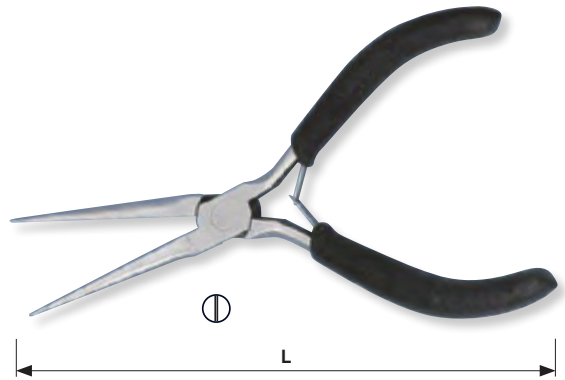

Electronic plain long nose pliers, angled 45°

*Alicate electrónica de manipulación,
angular 45°, bocas lisas*

**Alicate electrónico de puntas semi-redondas
suaves, angular 45°**

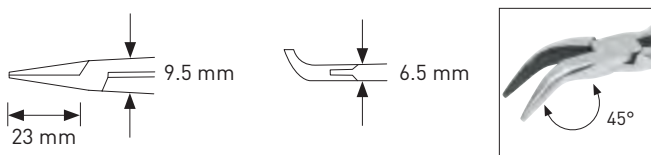

Art.	L mm
4234-115	115



HIGHTECH



Electronic long nose pliers, angled 45°

Alicate electrónica de manipulación, angular 45°

Alicate electrónico de puntas semi-redondas, angular 45°

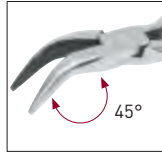

Art.	L mm
2238	115

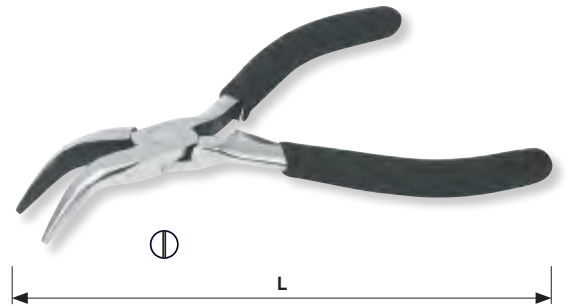

Electronic plain flat nose pliers

Alicate electrónica con bocas planas lisas

Alicate electrónico de puntas planas suaves

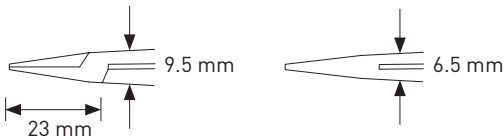

Art.	L mm
4231-115	115



HIGHTECH



Electronic flat nose pliers

Alicate electrónica con bocas planas

Alicate electrónico de puntas planas

Art.	L mm
2233	120



Electronic round nose pliers
Alicate electrónica con bocas redondas
Alicate electrónico de pontas redondas

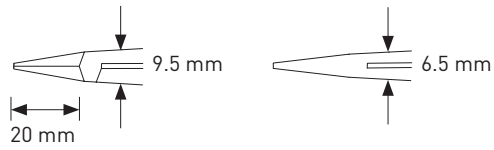

Art.	L mm
4232-115	115



HIGHTECH



Carpenter's pincers
Tenaza para carpintero
Turquês de carpinteiro

Art.	L mm
4242-180	180
4242-210	210
4242-250	250

HIGHTECH



Carpenter's pincers
Tenaza para carpintero
Turquês de carpinteiro

Art.	L mm
2216-180	180
2216-200	200



High leverage tower pincers
Tenaza de encofrador extra fuerte
Turquês de carpinteiro de alto desempenho

Art.	C Ø mm	M Ø mm	H Ø mm	L mm
4241-230	4.2	3.4	2.4	230
4241-260	4.2	3.8	2.6	260
4241-300	4.2	4.0	2.8	300

+ 45% POWER

HIGHTECH

 C 220 N/mm²

 M 750 N/mm²

 H 1800 N/mm²

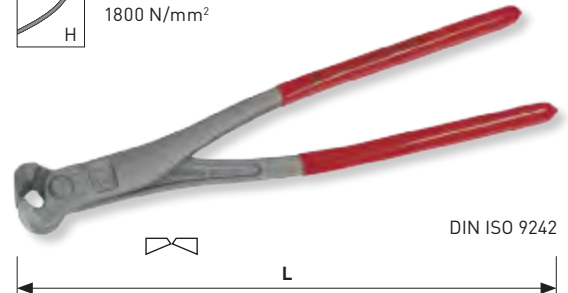

Tower pincers
Tenaza rusa
Alicate turquesa

Art.	L mm
2217-250	250
2217-280	280



Water pump pliers
 with inverted security box joint
Tenaza para bombas de agua
 con articulación machihembrada de seguridad

Alicate tipo bomba de água
 com articulação de encaixe de passagem de segurança

Art.	L1 mm	L2 mm
4223-180	40	180
4223-240	50	240
4223-300	65	300
4223-400	100	400

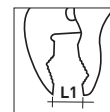

HIGHTECH



Water pump pliers

with inverted security box joint and direct adjusting push-button

Tenaza para bombas de agua

con articulación machihembrada de seguridad y botón de presión para ajuste directo

Alicate tipo bomba de água

com articulação de encaixe de passagem de segurança e botão de pressão de ajuste

Art.	L1 mm	L2 mm
4222-180	35	180
4222-250	50	250
4222-300	65	300

4Grip Water pump pliers

with inverted security box joint, direct adjusting push-button and automatic jaw adjustment = press the button, open the pliers, release the button and push the bottom jaw precisely to the workpiece! Dual serrated jaws for all kind of workpieces and nail-/wireholder. Safety protection for the fingers in every position. Compact, slim and robust.

Tenazas para bombas de agua 4Grip

con articulación de encaje y bisagra de seguridad, botón de ajuste de presión y ajuste automático de la mandíbula = presione el botón, abra la pinza y posicione la boca superior en la pieza. Bocas con doble dentado para todo tipo de piezas, clavos o alambres. Protección de seguridad para dedos en cualquier posición. Compacto, fino y robusto.

Alicate tipo bomba de água 4Grip

com articulação de encaixe de segurança, botão de pressão de ajuste e ajuste automático do maxilar = pressione o botão, abra o grampo e coloque na peça. Maxilares com duplo mordentes em forma de diamante para todas as peças, pregos e arame. Proteção de aperto em cada posição. Compacto, fino e robusto.

Art.	L1 mm	L2 mm
4224-250	50	250
4224-320	75	320
4224-400	100	400
4224	Set / Juego / Jogo 4224-250 + 4224-320	250 + 320



40% > DIN ISO

drag & drop

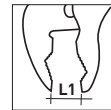

HIGHTECH



DIN ISO 8976

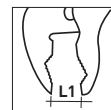
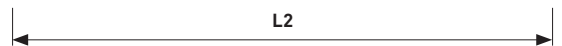

4GRIP

HIGHTECH

DIN ISO + 40%



DIN ISO 8976



2
PCS



Water pump pliers

with box joint and soft-grip handles

Tenaza para bombas de agua

con articulación machihembrada y mango soft-grip

Alicate tipo bomba de água

com articulação de encaixe de passagem e cabos soft-grip

Art.	L1 mm	L2 mm
3290-175	25	180
3290-250	32	250
3290-300	42	300
99067	Set / Juego / Jogo	180 + 250 + 300

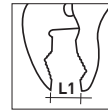

ERGOKRAFT



3
PCS

Automatic water pump pliers

with practical automatic adjustment for one-hand operation, optimal for narrow spaces. Isolated soft-grip handles.

Pinzas automáticas Quick-Grip

regulables con una sola mano, óptimo para espacios estrechos. Mango aislado.

Alicates bomba água Quick-Grip

Regulável com uma mão apenas. Ótimo para espaços apertados. Pegas isoladas.

Art.	L1 mm	L2 mm	L2 inch
3266-180	32	180	7"
3266-250	40	250	10"
3266-300	50	300	12"
3266SET	32+40+50	180+250+300	7"+10"+12"



3
PCS

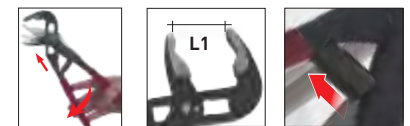

Pliers wrench

with inverted security box joint, direct adjusting push-button and swivelling, parallel gripping jaws.

Tenaza llave

con articulación de encaje y bisagra de seguridad, botón de ajuste de presión y ajuste automático de la mandíbula.

Alicate extensível tipo bomba de água

com articulação de encaixe de passagem de segurança, botão de pressão de ajuste e maxilares paralelos e móveis.

Art.	L1 mm / "	L2 mm
4225-250	0-53 / 0-2	250

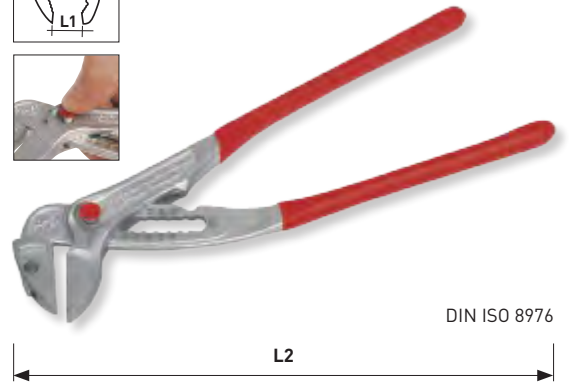
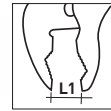

DIN ISO 8976

Swedish pattern pipe wrench

head 45°, angled S-type jaw

Llave grifa modelo sueco

cabeza 45°, dentado en "S"

Chave de tubos tipo sueca

cabeça 45°, mordente "S"

Art.	L1 inch	L2 mm
5406-320	1"	320
5406-420	1-1/2"	420
5406-540	2"	540

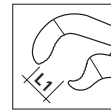

Stillson pattern pipe wrench

Llave grifa modelo Stillson

Chave de tubos tipo Stillson

Art.	L mm / inch
5405-250	250 / 10"
5405-350	350 / 14"
5405-450	450 / 18"
5405-600	600 / 24"
5405-900	900 / 36"



Pipe wrench with adjustable head

"Stillson"-type, with aluminium die cast body and 180° swivel aluminium handle, jaws made of chrome-molybdenum steel, infinitely adjustable with the knurling nut, maximum jaw-opening 2" / 52 mm.

Llave grifa con cabeza regulable

tipo "Stillson", con cuerpo de aluminio fundido, cabeza de aluminio regulable a 180°, bocas en acero cromo molibdeno, apertura regulable máximo 2" / 52 mm.

Chave de tubos com várias posições de cabeça

tipo "Stillson", com corpo em alumínio fundido, cabeça em alumínio regulável a 180°, bocas em aço molibdeno, abertura regulável 2" / 52 mm.

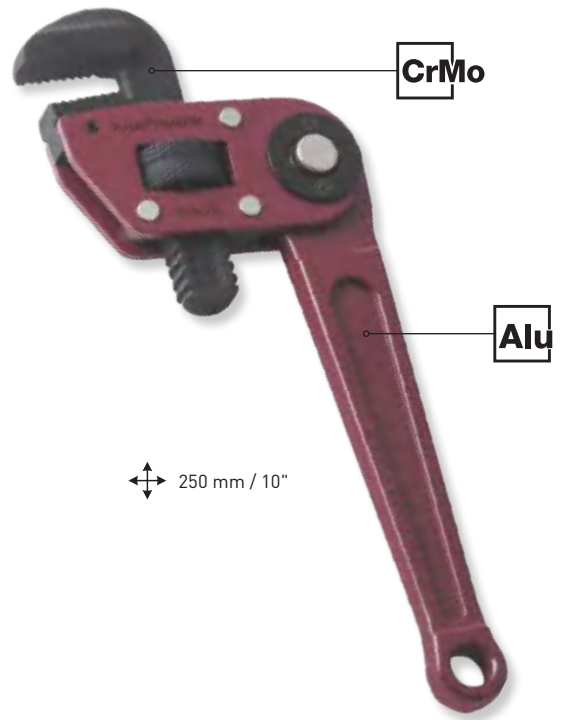

Art.
5405-290

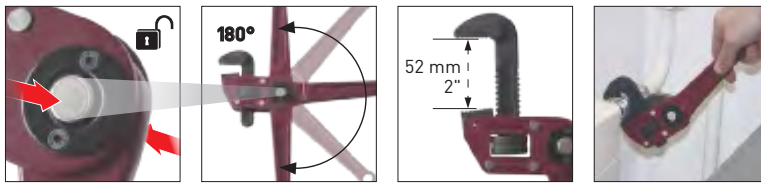

Step wrench set

5 steps, with go-through ratchet handle and socket adapter 1/2" dr.

Juego de llave de montaje graduada

5 graduaciones, con carraca pasante y adaptador llaves de vaso 1/2"

Jogo de chave de montagem escalonada

5 escalas, com roquete de aperto e adaptador chaves de caixa 1/2"

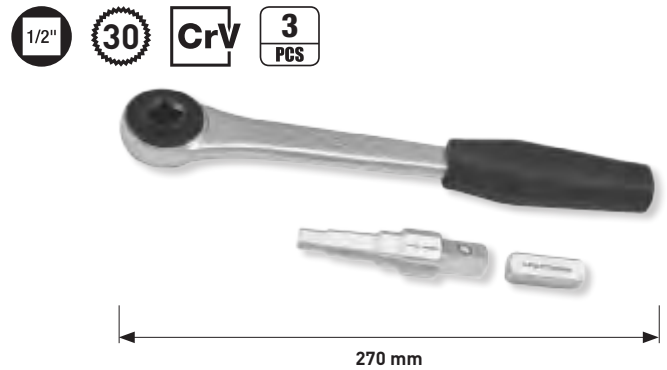

Art.	
5461SET	<ul style="list-style-type: none"> 10 mm 3/8" 11 mm 7/16" 12.5 mm 1/2" 16 mm 5/8" 21 mm 13/16"

Circlips pliers

for external rings, opening straight tips, with spring

Alicate para arandelas

exteriores, puntas abiertas y rectas

Alicate de freios

exteriores, pontas direitas abertas, com mola

Art.	Typ / mm	Ø mm	L mm
4252-A0	A0 / 3-10	0.9	135
4252-A1	A1 / 10-25	1.3	135
4252-A2	A2 / 19-60	1.8	175
4252-A3	A3 / 40-100	2.3	220
4252-A4	A4 / 85-165	3.2	310

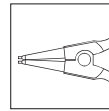

HIGHTECH

Circlips pliers

for external rings, opening straight tips, with spring

Alicate para arandelas

exteriores, puntas abiertas y rectas

Alicate de freios

exteriores, pontas direitas abertas, com mola

Art.	Typ / mm	Ø mm	L mm
2212-A2	A2 / 19-60	1.8	180

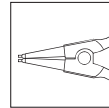

Circlips pliers

for external rings, opening 90° bent tips, with spring

Alicate para arandelas

exteriores, puntas abiertas y curvas en ángulo de 90°

Alicate de freios

exteriores, pontas angulares de 90° abertas

Art.	Typ / mm	Ø mm	L mm
4253-A01	A01 / 3-10	0.9	125
4253-A11	A11 / 10-25	1.3	125
4253-A21	A21 / 19-60	1.8	165
4253-A31	A31 / 40-100	2.3	200
4253-A41	A41 / 85-165	3.2	290

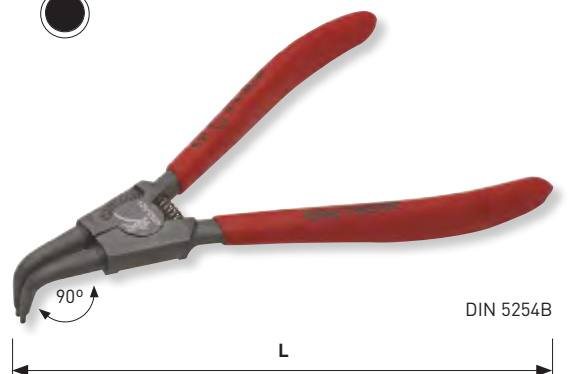
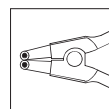

HIGHTECH

Circlips pliers

for external rings, opening 90° bent tips, with spring

Alicate para arandelas

exteriores, puntas abiertas y curvas en ángulo de 90°

Alicate de freios

exteriores, puntas angulares de 90° abiertas

Art.	Typ / mm	Ø mm	L mm
2213-A21	A21 / 19-60	1.8	165

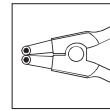

DIN 5254B

Circlips pliers

for internal rings, closing straight tips

Alicate para arandelas

interiores, puntas cerradas y rectas

Alicate de freios

interiores, puntas dereitas fechadas

Art.	Typ / mm	Ø mm	L mm
4254-J0	J0 / 8-13	0.9	135
4254-J1	J1 / 12-25	1.3	135
4254-J2	J2 / 19-60	1.8	175
4254-J3	J3 / 40-100	2.3	220
4254-J4	J4 / 85-165	3.2	310

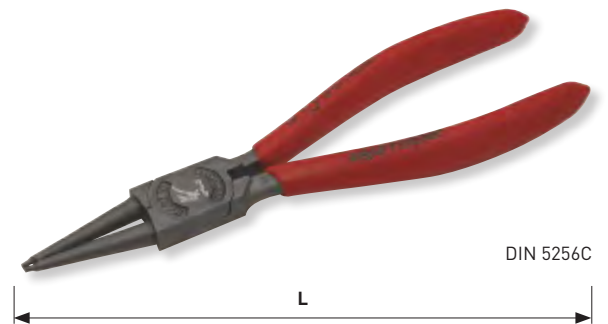
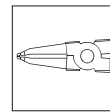

DIN 5256C

HIGHTECH

Circlips pliers

for internal rings, closing straight tips

Alicate para arandelas

interiores, puntas cerradas y rectas

Alicate de freios

interiores, puntas dereitas fechadas

Art.	Typ / mm	Ø mm	L mm
2214-J2	J2 / 19-60	1.8	180

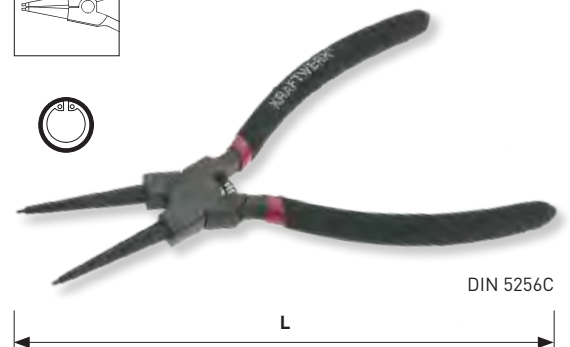
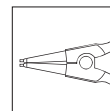

DIN 5256C

Circlips pliers

for internal rings, closing 90° bent tips

Alicate para arandelas

interiores, puntas cerradas y curvas en ángulo de 90°

Alicate de freios

interiores, pontas angulares de 90° fechadas

Art.	Typ / mm	Ø mm	L mm
4255-J01	J01 / 8-13	0.9	125
4255-J11	J11 / 12-25	1.3	125
4255-J21	J21 / 19-60	1.8	165
4255-J31	J31 / 40-100	2.3	200
4255-J41	J41 / 85-165	3.2	290

Circlips pliers

for internal rings, closing 90° bent tips

Alicate para arandelas

interiores, puntas cerradas y curvas en ángulo de 90°

Alicate de freios

interiores, pontas angulares de 90° fechadas

Art.	Typ / mm	Ø mm	L mm
2215-J21	J21 / 19-60	1.8	165

Circlips pliers set

Juego de alicates para arandelas

Jogo de alicates de freios

Art.	content / contiene / contém
4286	4252-A2, 4253-A21, 4254-J2, 4255-J21

Circlips pliers set

Juego de alicates para arandelas

Jogo de alicates de freios

Art.	content / contiene / contém
2212	2212-A2, 2213-A21, 2214-J2, 2215-J21

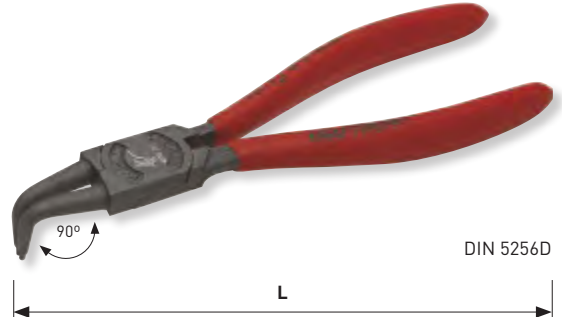
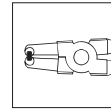

HIGHTECH

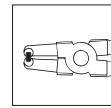

HIGHTECH

4
PCS

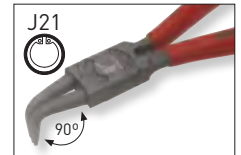
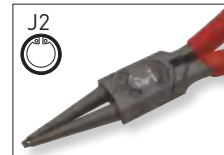
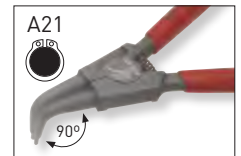

4
PCS

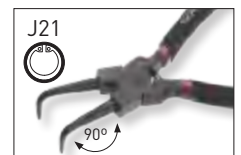
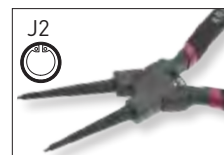
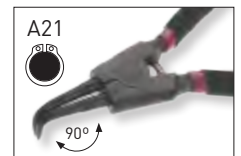

Combined 4-in-1 circlips pliers

for external and internal circlips from 10 to 50 mm, with 4 tip-heads for 180°, 90°, 45° to be changed within seconds, for 6 different applications.

Alicate combinado 4-en-1 para arandelas

exteriores e interiores de 10 a 50 mm com 4 cabeças de pontas de 180°, 90°, 45°. Cambio de cabeças em segundos para 6 usos diferentes.

Alicate combinado 4-em-1 para freios

exteriores e interiores de 10 a 50 mm com 4 cabeças de ponta para 180°, 90°, 45°. Trocando cabeças em segundos para 6 aplicações diferentes.

Art.	Typ / mm	Ø mm	L mm
2211	A1-A2, J1-J2 / 10-50 mm	1.35	155

4
PCS



Hose clip pliers

Alicate para racores

Alicate para abraçadeiras

Art.	L mm
4251-175	175



HIGHTECH

Tire balancing wheel weight plier

Alicate para el equilibrado de ruedas

Alicate para pesos

Art.	L mm
4256-240	240



AUTOMOTIVE

Curved jaws locking pliers
Tenaza grip de bocas curvas
Alicate de pressão maxilas côncavas

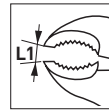

CrMo

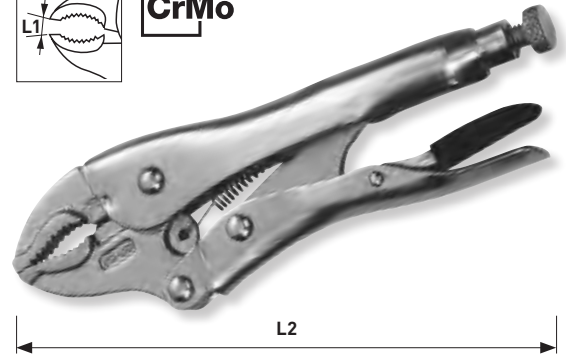

Art.	L1 mm	L2 mm / inch
3292-175	43	max. 175 / 7"
3292-250	58	max. 250 / 10"

Long nose locking grip pliers
Tenaza grip de bocas largas
Alicate de pressão bicos longos

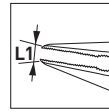

CrMo

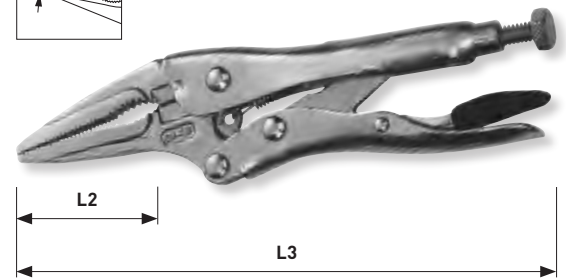

Art.	L1 mm	L2 mm	L3 mm / inch
3292-150	50	45	max. 150 / 6"

Locking welding clamp
Tenaza grip para soldador
Alicate de pressão para soldadura

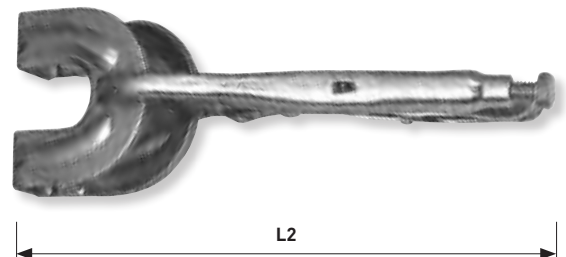
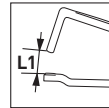

Art.	L1 mm	L2 mm / inch
2252-225	41	max. 225 / 9"

Sheet metal clamp
Tenaza grip para chapa
Alicate de pressão para latoeiros

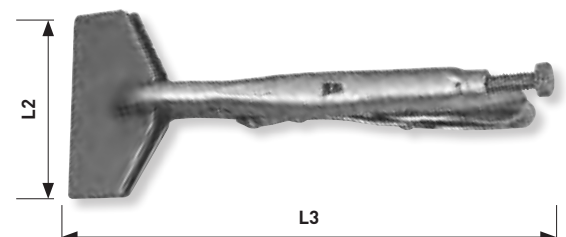
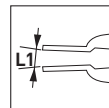

Art.	L1 mm	L2 mm	L3 mm / inch
2253-200	48	79	max. 200 / 8"

Locking "C"- clamp pliers
Mordaza grip de cuello de cisne
Alicate de pressão pescoço de cisne

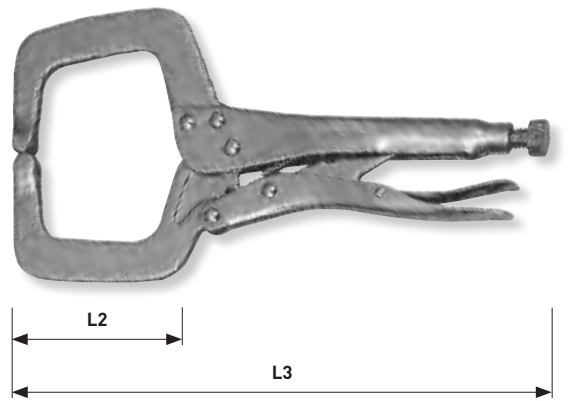
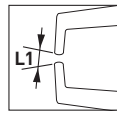

Art.	L1 mm	L2 mm	L3 mm / inch
2254-275	95	95	max. 275 / 11"

Revolving punch pliers
Pinza sacabocados de revolver
Alicate vazador

HIGHTECH



Art.	Ø mm	L mm
4248-220	2 - 4.5	220

Lever action revolving punch pliers
Pinza sacabocados de revolver con función carraca
Alicate vazador com função roquete

HIGHTECH



Art.	Ø mm	L mm
4248-250	2 - 4.5	250

Revolving punch and eyelet pliers
Pinza de sacabocados y ojales de revolver
Alicate vazador e colocação de olhais

HIGHTECH



Art.	Ø mm	L mm
4249-220	4 - 5	220

Hand riveter

Remachadora manual

Alicate de rebitar manual

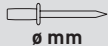
Art.	 \varnothing mm	L mm
2223	2.4-3.2-4.0-4.8	250





Hand riveter set

Kit remachadora manual

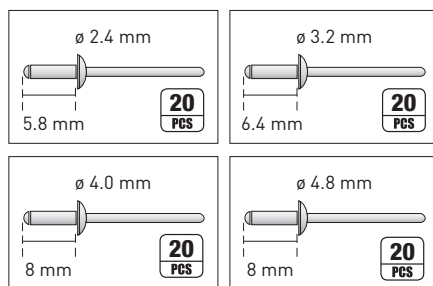
Conjunto de alicates de rebitar manual

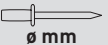

Art.	 \varnothing mm	 pcs.
2224	2.4-3.2-4.0-4.8	20



Nozzle for hand riveter

Boquilla para remachadora manual

Nariz para alicate de rebitar manual

Art.	\varnothing mm
2223-2.4	2.4
2223-3.2	3.2
2223-4.0	4.0
2223-4.8	4.8



Pair of jaws for hand riveter

Par de mordazas para remachadora manual

Par de garras para alicate de rebitar manual

Art.
2223-01

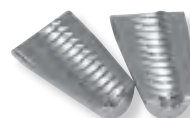

Industrial hand riveter tool case
Estuche remachadora manual industrial
Kit de alicates de rebitar manual industrial



HIGHTECH

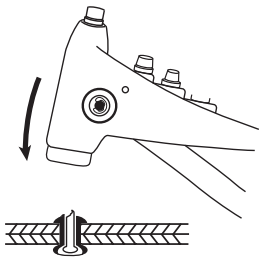

<p>∅ 2.4 mm 5.8 mm 50 PCS</p>	<p>∅ 3.2 mm 8 mm 50 PCS</p>
<p>∅ 4.0 mm 8 mm 50 PCS</p>	<p>∅ 4.8 mm 8 mm 30 PCS</p>

320 x 148 x 48 mm

Art.	∅ mm
4261	2.4-3.2-4.0-4.8

Nozzle for hand riveter
Boquilla para remachadora manual
Nariz para alicate de rebitar manual

Art.	∅ mm
4261-1	2.4
4261-2	3.2
4261-3	4.0
4261-4	4.8



Pair of jaws for hand riveter
Par de mordazas para remachadora manual
Par de garras para alicate de rebitar manual

Art.
4261-5



Industrial lever type hand riveter tool case
Estuche remachadora manual con efecto palanca
Kit de alicata de rebitar de brazos industrial



HIGHTECH

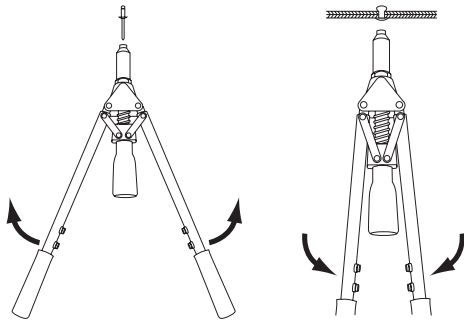

575 x 185 x 52 mm

Art.	Ø mm
4262	3.2-4.0-4.8-6.0-6.4

Nozzle for hand riveter
Boquilla para remachadora manual
Nariz para alicata de rebitar manual

Art.	Ø mm
4262-1	3.2
4262-2	4.0
4262-3	4.8
4262-4	6.0
4262-5	6.4



Jaws for hand riveter
Bocas para remachadora manual
Garras para alicata de rebitar manual

Art.
4262-7



Nozzle Monobolt for hand riveter
Boquilla Monobolt para remachadora manual
Nariz Monobolt para alicata de rebitar manual

Art.	Ø mm
4262-8	4.8/5 MB
4262-9	6.4mm MB



Industrial hand rivet nut tool case
Estuche de remachadora de tuerca industrial
Kit de alicata de rebitar manual industrial



HIGHTECH

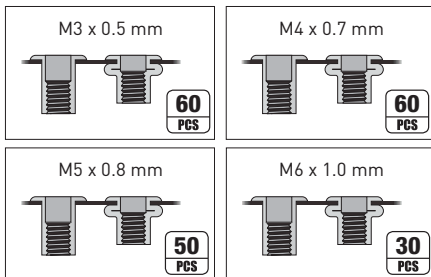

Art.	
4263	M3-M4-M5-M6

 320 x 148 x 48 mm

Rivet nut nozzle
Boquilla para remachadora de tuerca
Nariz para alicata de rebitar

Art.	
4263-1	M3
4263-2	M4
4263-3	M5
4263-4	M6



Thread bolt for hand rivet nut tool
Repuesto para remachadora de tuerca
Cabeça parafuso para alicata de rebitar

Art.	Ø
4263-5	M3
4263-6	M4
4263-7	M5
4263-8	M6



Industrial lever hand rivet nut tool kit
Estuche de remachadora de tuerca extrafuerte
Kit de alicates de rebitar de braços industrial



HIGHTECH

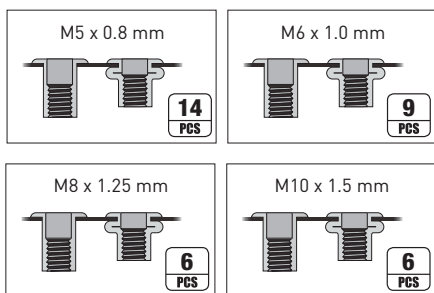

↔ 575 x 185 x 52 mm

Art.	
4264	M5-M6-M8-M10

Threaded mandrel and nose piece
Cabezal para remachadora de tuerca
Mandril e bico para alicates de rebitar de braços industrial

Art.	
4264-1	M4
4264-2	M5
4264-3	M6
4264-4	M8
4264-5	M10



Bolt cutter

with specially precisely polished heads made of chrome molybden steel. Ergonomic bi-material handles.

Cortavarilla

con cabezas pulido especial, realizado en acero cromo molibdeno. Mangos ergonómicos bimatériaes.

Corta parafusos

com cabeças especiais polidas, fabricado em aço cromo molibdênio. Punhos ergonómicos bimatéria.

Art.	15 HRC mm	35 HRC mm	L mm / inch
4260-18	8	6	450 / 18"
4260-24	10	8	600 / 24"
4260-30	13	10	750 / 30"
4260-36	16	11	900 / 36"
4260-42	18	13	1050 / 42"



HIGHTECH

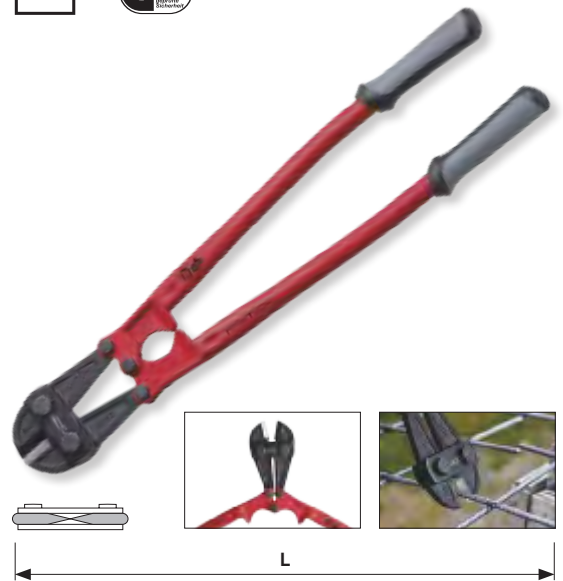

Spare-head-set for bolt cutter

Recambio boca cortavarillas

Cabeça para corta parafusos

Art.	L mm / inch
4260-18E	450 / 18"
4260-24E	600 / 24"
4260-30E	750 / 30"
4260-36E	900 / 36"
4260-42E	1050 / 42"



HIGHTECH

Mini cable cutter

Juego cuchillas para cortavarillas

Mini Corta Cabos

Art.	H mm	S mm	L mm
2262-07	2.5	4.0	195

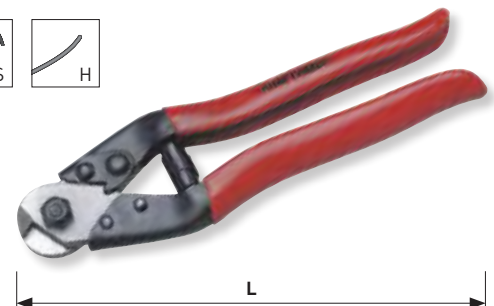

Strap wrench
Llave de correa
Chave de cinta

Art.	∅ mm	L mm / inch
5418-300	0 - 225mm / 9"	300 / 12"





Tube bender 3 in 1
Curvadora 3 en 1
Curvador de tubos 3 em 1

Art.	∅	C	L mm
5451	1/4" - 3/8" Cu / Me / Al	max. 180°	225



Crimping pliers
Alicate para engastar terminales
Alicate de cravar terminais

Art.	 mm ²	 mm ²	L mm
2225	1.5 - 6	1.5 - 6	240

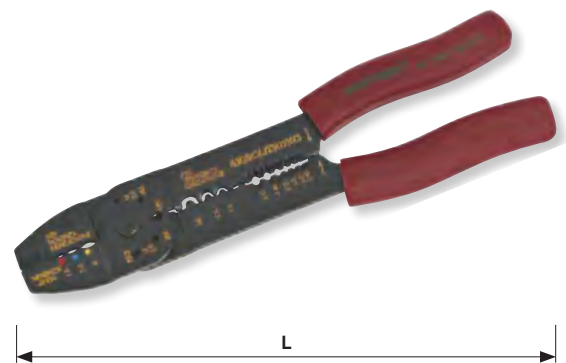

5-in-1 crimping and wire stripping pliers



hardened and with ground edges for professional and industrial use.

Alicate para engastar con pelacables "5 en 1"

endurecido y con bordes redondeados para uso profesional e industrial.

Alicate 5-em-1 cravar e descarnar

endurecido para uso profissional e industrial.

Art.	 mm ²	 mm ²	L mm
3290-230	1.5 - 6	1.5 - 6	230

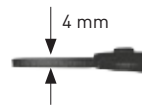

ERGOKRAFT

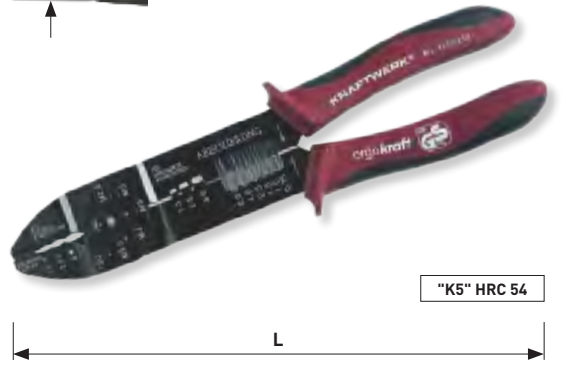

1.5-2.5-4.6 mm²

Wire cutter
Corta cable
Corta fios



1.5-2.5-6.0 mm²

Crimping pliers for insulated terminals
Alicate para engastar terminales no aislados
Crava terminais isolados



M2.6-M3.5-M4-M5

Bolt cutter
Para pernos
Corta parafusos

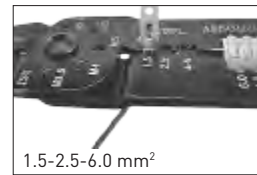

1.5-2.5-6.0 mm²

Crimping pliers for open barrel terminals
Engastar terminales abiertos
Crava terminais abertos

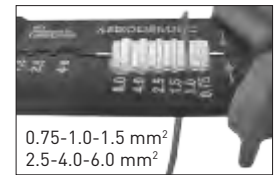

0.75-1.0-1.5 mm²
2.5-4.0-6.0 mm²

Wire Stripper for cables
Pelacables
Descarnador de fios

Ratchet lever crimping pliers

with interchangeable jaws including crimping jaws for insulated terminals and closed, non insulated terminals and non insulated ferrules.

Alicates de carraca para engastar terminales

con cabezales intercambiables para terminales de cables aislados y terminales de cables sin aislar.

Alicate de roquete para cravar terminais

com cabeças intermutáveis incluindo para terminais isolados e terminais não-isolados.

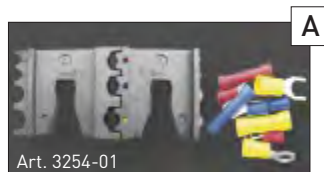

Art. 3254-01

DIN 0.5-1.0 / 1.5-2.5 / 4-6 mm²
AWG 22-18 / 16-14 / 12-10



Art. 3254-02

DIN 1.5 / 2.5 / 6 / 10 mm²
AWG 20-18 / 16-14 / 12-10 / 8
JIS 1.25 / 2 / 5.5 / 8 mm²

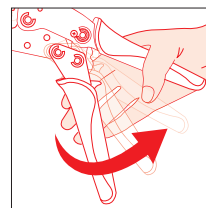
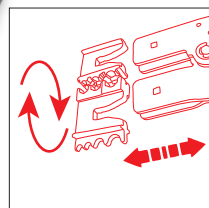

12
PCS



Art.	incl. 	L mm
3254	1x 3254-01 1x 3254-02	220

Ratchet lever crimping pliers case

with interchangeable jaws including crimping jaws for insulated terminals and closed, non insulated terminals and non insulated ferrules.
Empty compartments for supplementary jaws or to store terminals.

Estuche de alicates de carraca para engastar terminales

con cabezales intercambiables para terminales de cables aislados y terminales de cables sin aislar.
Compartimentos vacíos para los cabezales suplementarios y depósito de terminales.

Alicate de roquete para cravar terminais em Estojo

com cabeças intermutáveis incluindo para terminais isolados e terminais não-isolados.
Compartimentos vazios para cabeças suplementares.
Gli scomparti vuoti possono essere utilizzati per le ganasce supplementari o per i terminali non utilizzati.



280 x 150 x 40 mm



Art. 3291-01
DIN 0.5-1.0 / 1.5-2.5 / 4-6 mm²
AWG 20-18 / 16-14 / 12-10



Art. 3291-02
DIN 1.5 / 2.5 / 6 / 10 mm²
AWG 20-18 / 16-14 / 12-10 / 8
JIS 1.25 / 2 / 5.5 / 8 mm²



Art.	incl.	L mm
3291	1x 3291-01 1x 3291-02	220

Ratchet lever crimping pliers without jaw

Alicates de carraca para engastar terminales sin cabezal intercambiable

Alicate de Roquete para cravar terminais sem cabeça



Art.	L mm
3291-220	220

Optional crimp jaws

Bocas opcionales

Opcional crimp morre

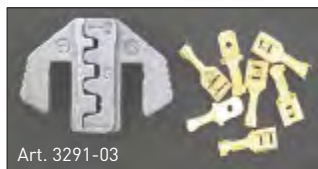

Art. 3291-03
DIN 0.5-1.0 / 1.5-2.5 / 4-6 mm²
AWG 20-18 / 16-14 / 12-10



Art. 3291-04
DIN 0.5 / 0.75 / 1.0 / 1.5 / 2.5 / 4.0 mm²
AWG 22 / 20 / 18 / 16 / 14 / 12

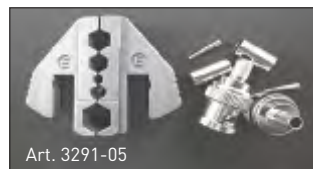

Art. 3291-05
Coaxial RG 58, 59, 62, 6.
6.48 / 5.41 / 2.5 / 1.72 / 8.23 mm²
0.255 / 0.213 / 0.1 / 0.68 / 0.324"

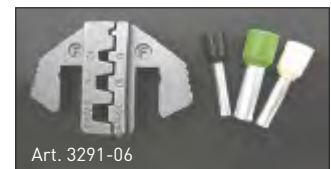

Art. 3291-06
DIN 6 / 10 / 16 mm²
AWG 10 / 8 / 6



Art. 3291-07
4P4C / RJ22



Art. 3291-08
6P2C / 6P4C / RJ11
6P6C / RJ12



Art. 3291-09
8P8C / RJ45



Art. 3291-10
DIN 2.5 / 0.5 / 8-10 mm²
AWG 14 / 22 / 8-6

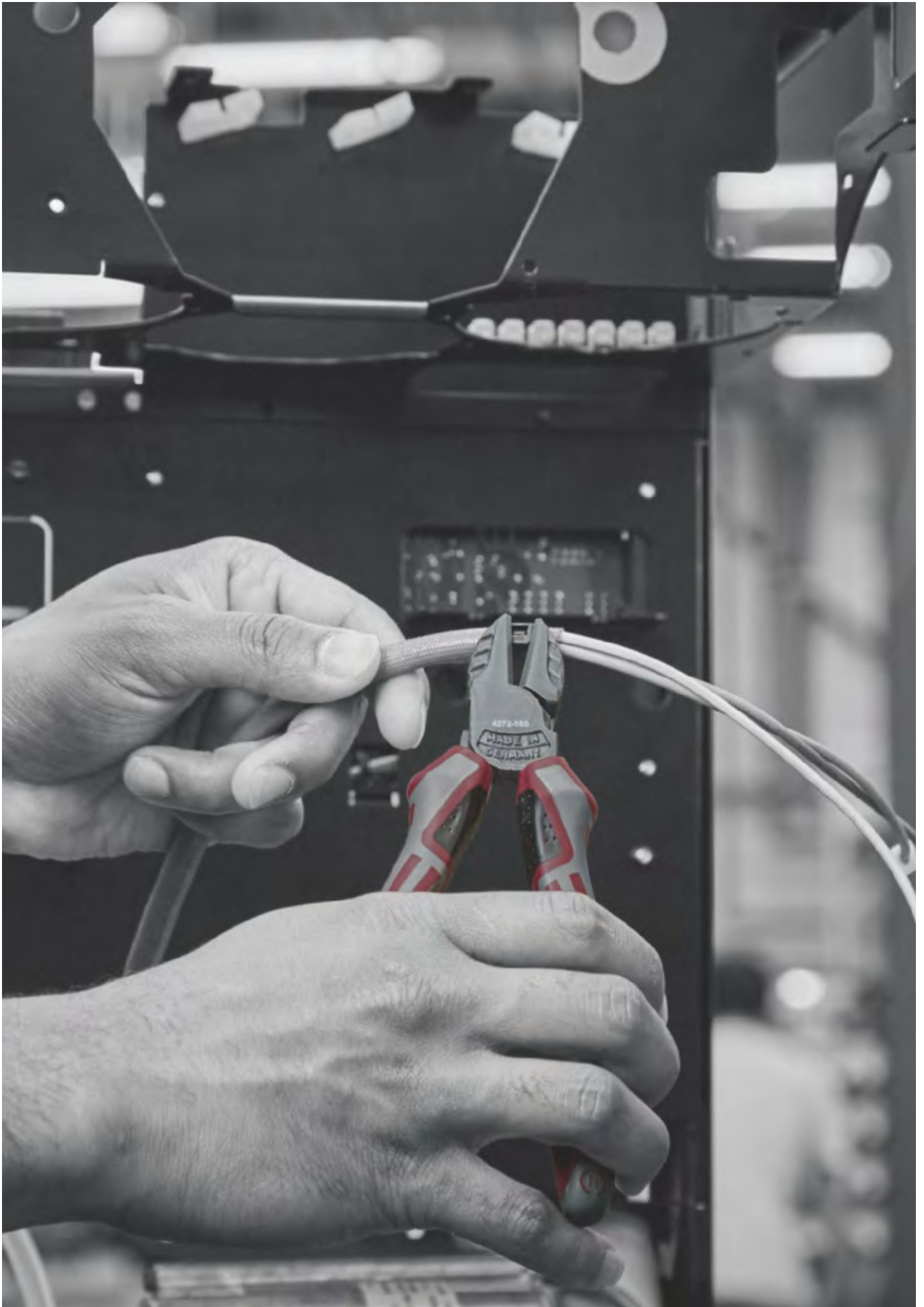



Utility knife with trapezoid blade

with metal body and 2-material handle, 3-positions adjustable blade, integrated cord-cutter and integrated blade-storage with 5 blades in the handle.

Cúter universal de lamas trapezoidales

con cuerpo metálico y mango bimatèrial, lama ajustable de 3 posiciones, cortacables integrado y 5 cuchillas de recambio dentro del mango.

Faca universal de lamina trapezoidal

com corpo de metal e punho em bimatéria, lâmina ajustável por 3 posições, corta fois incorporado, 5 laminas extra dentro do cabo.

Art.	L mm
3301	180

ERGOKRAFT

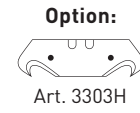
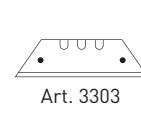

Jackknife with trapezoid blade

with ergonomic, non slip 2-component handle. Safety quick-release mechanism for the blade. Quick locking system of the blade-holder. Including 10 trapezoid blades with dispenser.

Cúter trapezoidal plegable

con mango ergonómico bimatèrial antideslizante. Mecanismo de seguridad para la extracción de la hoja. Sistema de fijación rápido de la hoja. Incluye 10 hojas trapezoidales con dispensador.

Faca com lâminas trapezoidais

cabo ergonómico de 2 componentes. Sistema de segurança na lâmina. Sistema de bloqueio do suporte de lâmina. Inclui 10 lâminas.

Art.	L mm
3304	155

ERGOKRAFT

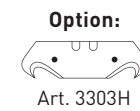
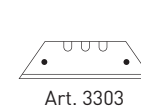
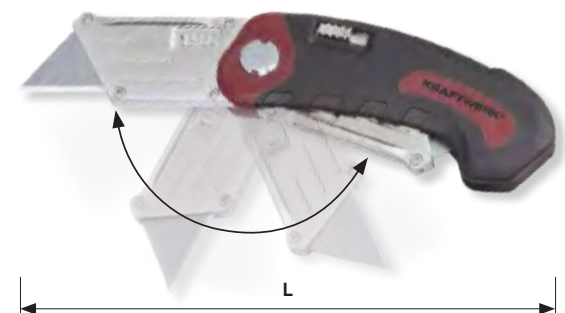

Universal safety cutter with trapezoid blade

with metal body and safety spring, which results in an automatic retention of the blade after releasing the button.

Cúter universal de seguridad de lamas trapezoidales

con cuerpo metálico y muelle de seguridad, para la retención automática de la lama después de soltar el botón.

Faca de segurança com lâminas trapezoidais

com corpo de metal e mola de segurança para retenção automática da lâmina depois de soltar o botão.

Art.	L mm
3302	150

Trapezoid blade set

for cutters 3301, 3302 and 3304. Dispenser with 5 pieces

Cuchillas trapezoidales de recambio

para cuters 3301, 3302 y 3304. Dispensador con 5 piezas

Jogo de lâminas trapezoidais

para facas 3301, 3302 e 3304. Dispositivo com 5 peças

Art.	L mm	H mm
3303	65	19

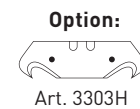
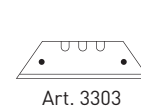
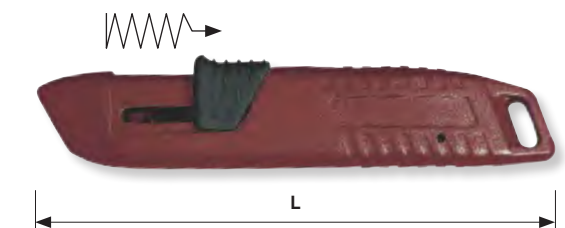

5
PCS

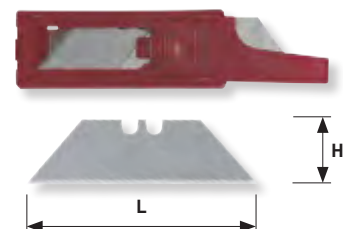

Hook blade set

for cutters 3301, 3302 and 3304. Dispenser with 5 pieces

Cuchillas de gancho de recambio

para cuters 3301, 3302 y 3304. Dispensador con 5 piezas

Jogo de lâminas trapezoidais gancho

para facas 3301, 3302 e 3304. Dispositivo com 5 peças

Art.	L mm	H mm
3303H	50	19

5
PCS

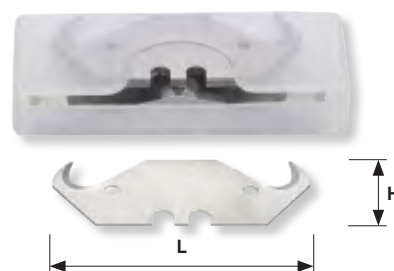

Snap-off cutter

Ergonomic ABS-handle with soft grip. Stainless steel blade guide, automatic blade locking system. Including 3 snap-off blades.

Cúter universal de hoja fraccionable

Mango ergonómico ABS con agarre suave. Guía de la hoja de acero inoxidable, sistema automático de bloqueo de la hoja.

Incluye 3 hojas de repuesto con filos múltiples fraccionables.

X-acto

Corpo ergonômico ABS com grip macio. Guia de lâmina de aço inoxidável, sistema de bloqueio da lâmina automática.

Inclui 3 lâminas divisíveis.

Art.	L mm
3310	135

ERGOKRAFT

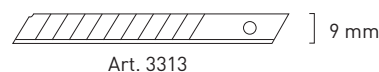

Snap-off cutter

with solid metal body. Stainless steel blade guide, automatic blade locking system.

Cúter universal de hoja fraccionable

con cuerpo metálico. Guía de la hoja de acero inoxidable, sistema automático de bloqueo de la hoja.

X-acto

com corpo metálico. Guia de lâmina de aço inoxidável, sistema de bloqueio da lâmina automática.

Art.	L mm
3317	130

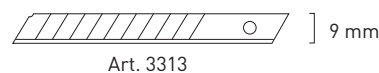

Stainless steel snap-off cutter

with slim body, safety-lock and metal clip

Cúter universal en acero inoxidable

con cuerpo delgado, bloqueo automático de la hoja y clip de bolsillo.

X-acto de aço inoxidável

modelo plano com fecho segurança e clip de bolso

Art.	L mm
3311	129

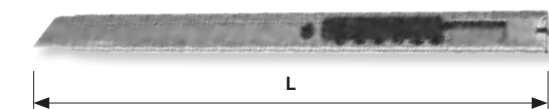

Spare snap-off-blades

with 12 segments per blade, 10 pieces in solid plastic case

Cuchillas separables de recambio

con 12 segmentos por cuchilla, 10 piezas en caja de almacenamiento

Lâminas divisível de reposição

com 12 segmentos por lâmina, 10 peças em caixa de armazenamento

Art.	L mm	H mm
3313	85	9

Snap-off cutter

Ergonomic ABS-handle with soft grip. Stainless steel blade guide, automatic snap off blade reloading and blade locking system. Including 6 spare snap-off blades.

Cúter universal de hoja fraccionable

Mango ergonómico ABS con agarre suave. Guía de la hoja de acero inoxidable, sistema de recarga automática y de bloqueo de la hoja. Incluye 6 hojas de repuesto con filos múltiples fraccionables.

X-acto

Corpo ergonômico ABS com grip macio. Guia de lâmina de aço inoxidável, recarga automático e sistema de bloqueio da lâmina. Incluindo 6 lâminas de reposição divisível.

Art.	L mm
3312	165

Snap-off cutter

Ergonomic ABS-handle with soft grip. Stainless steel blade guide, wheel blade lock. Including 3 snap-off blades.

Cúter universal de hoja fraccionable

Mango ergonómico ABS con agarre suave. Guía de la hoja de acero inoxidable, bloqueo de la hoja de rueda selectora. Incluye 3 hojas de repuesto con filos múltiples fraccionables.

X-acto

Corpo ergonômico ABS com grip macio. Guia de lâmina de aço inoxidável, roda de bloqueio da lâmina. Inclui 3 lâminas divisíveis.

Art.	L mm
3315	167

Snap-off cutter

with solid metal body. Stainless steel blade guide, automatic blade locking system.

Cúter universal de hoja fraccionable

con cuerpo metálico. Guía de la hoja de acero inoxidable, sistema automático de bloqueo de la hoja.

X-acto

com corpo metálico. Guia de lâmina de aço inoxidável, sistema de bloqueio da lâmina automática.

Art.	L mm
3318	155

10
PCS

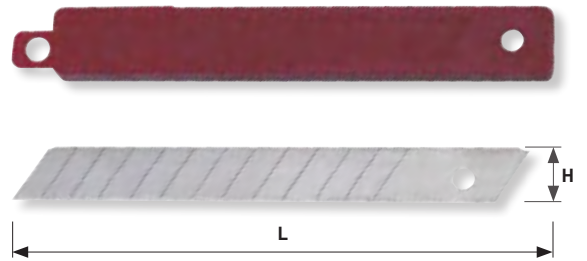

ERGOKRAFT

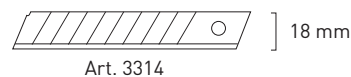
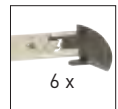
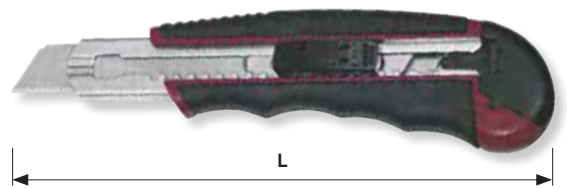

ERGOKRAFT

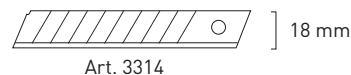
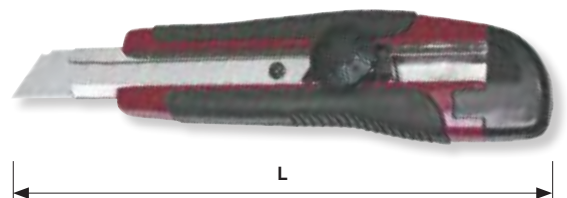

Spare snap-off-blades

with 7 segments per blade, 10 pieces in solid plastic case

Cuchillas separables de recambio

con 7 segmentos por cuchilla, 10 piezas en caja de almacenamiento

Lâminas divisível de reposição

com 7 segmentos por lâmina, 10 peças em caixa de armazenamento

Art.	L mm	H mm
3314	109	18

10
PCS

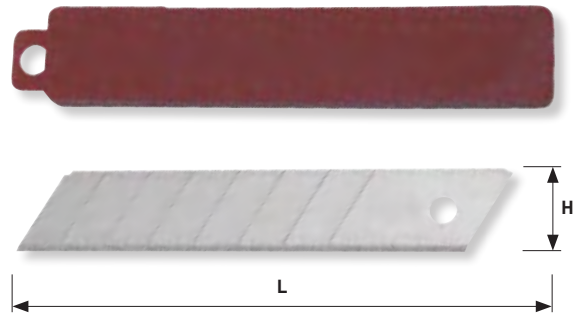

Foldaway knife

with matt finish high grade stainless steel blade, blade locking mechanism, aluminium handle and clip on the back.

Navaja acero

con cuchilla inoxidable acabado mate, bloqueo de hoja, mango de aluminio y clip.

Navalha universal

com acabamento mate em aço inox lamina de alta qualidade, mecanismo de bloqueio da lamina, cabo em aluminio e clip no verso.

Art.	L1 mm	L2 mm
3323	112	188

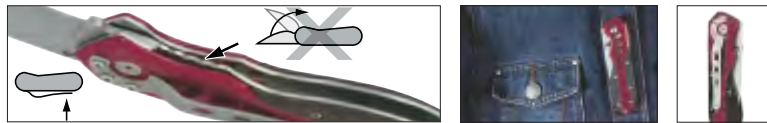

Multiuse foldaway tool, set

Pliers with wire cutter, 8 functional tool-blades in the handles. Delivered with penknife in the same style and nylon belt carrying case.

Herramienta multiuso

plegable, con alicate cortante y 8 hojas de herramientas funcionales en el mango. Incluye cuchillo de bolsillo en funda de nylon para cinturón.

Ferramenta multiusos

Alicate com corta fios, 8 laminas multifuncionais no cabo. Inclui navalha do mesmo estilo e bolsa de transporte em nylon

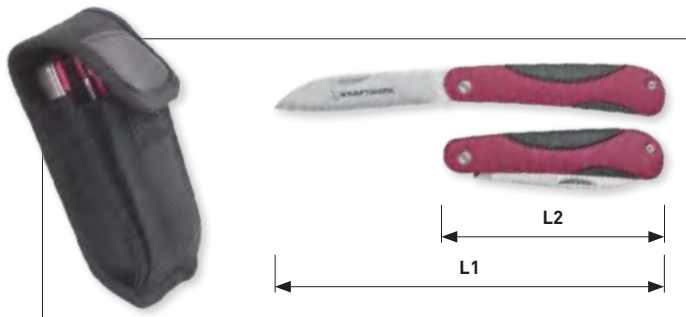

Art.	L1 mm	L2 mm	L3 mm	L4 mm
3322	188	112	100	160



Electrician knife

with double blade

Navaja de electricista

con doble cuchilla

Navalha de electricista

com lâmina dupla

Art.	L mm
3325	190



Marine knife

Cuchillo de marinero

Faca marinha



Art.
3324



Dismantling tool

especialmente suitable for larger cross-sections and for difficult insulating materials

Pelacable

especialmente adecuado para secciones mayores y materiales de aislamiento difíciles

Descarnador cabos

especialmente adecuado para seções transversais maiores e para isolantes de difícil manuseio



Art.	∅ mm ²	L mm
2230	8 - 28	142



Pipe cutter for plastic pipes
Cortatubos para tubos de plástico
Corta tubos para tubos plásticos

Art.	∅ mm	∅ inch	L mm
5441	0 - 42	0 - 1-5/8	190

PP, PE, PEX, PB, PVDF



Spare blade

for art. 5441

Cuchilla de repuesto

para art. 5441

Laminas de reposição

para art. 5441

Art.	H mm	L mm
5441E	30	105



General tube cutter

for copper, brass, aluminium and thin walled steel pipes.

Foldable internal deburrer

Cortatubos general

para cobre, bronce, aluminio, tuberías de acero con paredes finas.

Desbarbador interno plegable

Corta tubos universal

para cobre, latão, alumínio, e tubos de aço com paredes finas.

Limpa tubos retrátil

Art.	∅ mm	L mm
5432	Cu/Al/Me 3 - 32	150

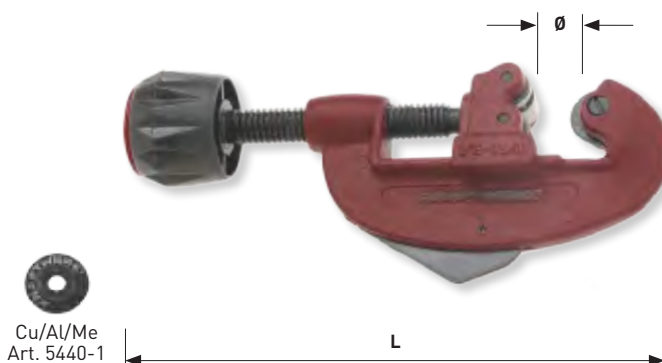

Telescope tube cutter

for stainless steel tubes. Precise working in confined spaces. Quick adjustment. Retractable internal pipe deburrer.

Cortatubos telescópico

para acero inoxidable. Para trabajos precisos en espacios limitados. Ajuste rápido. Desbarbador retráctil integrado.

Corta tubos telescópico

para aço inoxidável. Para trabalhos precisos e em locais de difícil acesso. Ajuste rápido. Limpa tubos retrátil.



Art.	Ø mm	L mm
5436	Inox 6 - 42	170



Cutting wheel for tubing cutters

Cuchilla de repuesto para cortatubos

Lamina para corta tubos

Art.	Mat.	Ø mm	L mm
5440-1	Cu/Al/Me	18	2.9

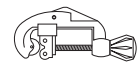

Art. 5432

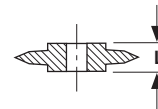

Cutting wheel for tubing cutters

Cuchilla de repuesto para cortatubos

Lamina para corta tubos

Art.	Mat.	Ø mm	L mm
5440-3	Cu/Al/Me	18	6.0
5440-5	Inox	18	6.0

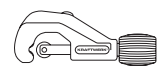

Art. 5436

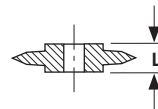

Cutting wheel for tubing cutters

Cuchilla de repuesto para cortatubos

Lamina para corta tubos

Art.	Mat.	Ø mm	L mm
5440-5ES	Inox	18	6.0

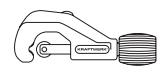

Art. 5436

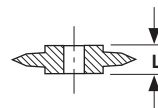



Reamer

for internal and external use

Escariador metal

para interior y exterior

Escareador metal

interior/exterior

Art.	Ø mm	D mm	L mm
5470	6 - 40	52	55

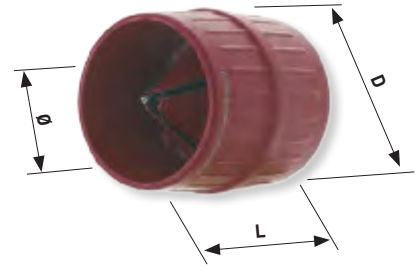

Mini scraper

Mini raspador

Mini raspador

Art.
3338
3338E Replacement Blades / Hojas de repuesto / Lâminas de reposição

10
PCS



Universal scissors

Tijera universal

Tesoura universal

Art.	L mm
2240	185



ERGOKRAFT



Electrician's scissors
Tijera de electricista
Tesoura de electricista

Art.	L mm
2251	142



Compound action snips

left cut, with bi-material handles

Tijera articulada

de corte izquierda, mangos bimatèrial

Tesoura articulada

de corte a esquerda, cabos bi-matèria

Art.	L mm	HRC	∠ MH mm	Inox 80kg/mm ² mm
2241	250	58 - 60	1.2	0.8

CrMo



Compound action snips

right cut, with bi-material handles

Tijera articulada

de corte derecha, mangos bimatèrial

Tesoura articulada

de corte a direito, cabos bi-matèria

Art.	L mm	HRC	∠ MH mm	Inox 80kg/mm ² mm
2242	250	58 - 60	1.2	0.8

CrMo

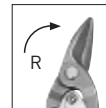

Compound action snips

straight cut, with bi-material handles

Tijera articulada

de corte recto, mangos bimatèrial

Tesoura articulada

de corte direito, cabos bi-matèria

Art.	L mm	HRC	∠ MH mm	Inox 80kg/mm ² mm
2243	250	58 - 60	1.2	0.8

Compound action snips set

Juego tijeras articuladas

Conjunto de tesouras articuladas

Art.	L mm	HRC	∠ MH mm	Inox 80kg/mm ² mm
2244	250	58 - 60	1.2	0.8



Compound action offset snips

left cut, with bi-material handles

Tijera articulada de corte rectilíneo

de corte izquierda, mangos bimatèrial

Tesoura articulada para cortes rectilíneos

de corte a esquerda, cabos bi-matèria

Art.	L mm	HRC	∠ MH mm	Inox 80kg/mm ² mm
2245	240	58 - 60	1.2	0.8

Compound action offset snips

right cut, with bi-material handles

Tijera articulada de corte rectilíneo

de corte derecha, mangos bimatèrial

Tesoura articulada para cortes rectilíneos

de corte a direito, cabos bi-matèria

Art.	L mm	HRC	∠ MH mm	Inox 80kg/mm ² mm
2246	240	58 - 60	1.2	0.8

CrMo

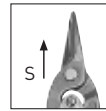

CrMo

3 PCS



CrMo



CrMo

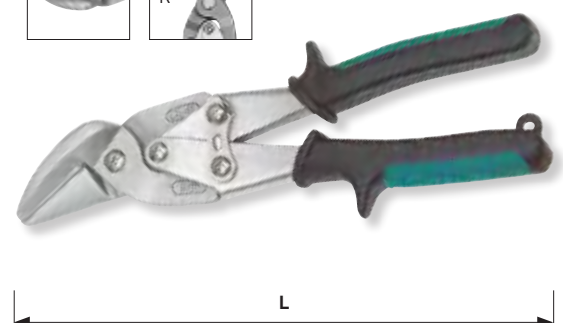
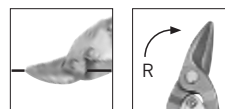

Hacksaw frame

with HSS bi-metal saw blade, 2-component handle and quick-change blade device

Arco de sierra

con hoja de sierra en HSS bimetálica, mango bimetálico y cambio rápido de la hoja

Serrote

com folha de serra HSS bimetálica, punho de 2 componentes e sistema rápido de mudar a lamina

Art.	L1 mm	L2 mm
3305	300	400

 Art. 3316

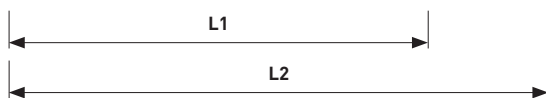

Straight hacksaw blade holder

with 2-component handle

Mango sierra

bimaterial

Serrote punho direito

de 2 componentes

Art.	L1 mm	L2 mm
3308-1	163	315

 Art. 3316





ERGOKRAFT

Hacksaw blade

Hoja de sierra

Folha de serra

Art.	L mm	 cm	
3316-18	300	7	18
3316-24	300	10	24
3316-32	300	13	32



DIN 6494 / ISO 2336-1

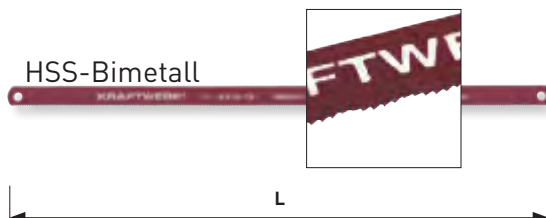

Mini hacksaw frame

Arco de sierra mini

Mini serrote Junior

Art.	L1 mm	L2 mm
3309	150	250

 Art. 3319

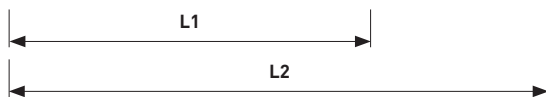

Hacksaw blade for mini hacksaw

Hoja de sierra mini

Folha de serra mini

Art.	L mm	 cm	
3319	150	10	24



Flat file

second cut, with 2-component handle

Lima punta plana

de corte semisuave, con mango bimatèrial

Lima direita

meio-murça, com cabo bi-matéria

Art.	L1 mm	L2 mm
4320-1	200	320

Half-round file

second cut, with 2-component handle

Lima media caña

de corte semisuave, con mango bimatèrial

Lima meia-cana

meio-murça, com cabo bi-matéria

Art.	L1 mm	L2 mm
4320-2	200	320

Round file

second cut, with 2-component handle

Lima redonda

de corte semisuave, con mango bimatèrial

Lima redonda

meio-murça, com cabo bi-matéria

Art.	L1 mm	L2 mm
4320-3	200	320

Square file

second cut, with 2-component handle

Lima cuadrada

de corte semisuave, con mango bimatèrial

Lima quadrada

meio-murça, com cabo bi-matéria

Art.	L1 mm	L2 mm
4320-4	200	320

Three-square file

second cut, with 2-component handle

Lima triangular

de corte semisuave, con mango bimatèrial

Lima triangular

meio-murça, com cabo bi-matéria

Art.	L1 mm	L2 mm
4320-5	200	320

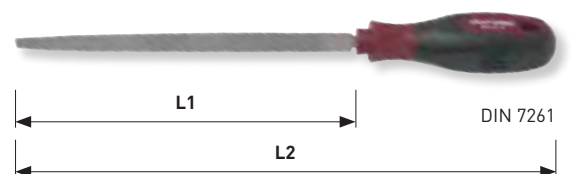
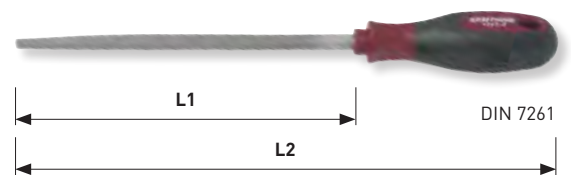
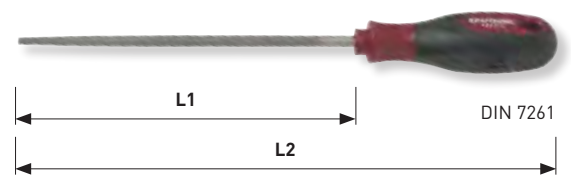
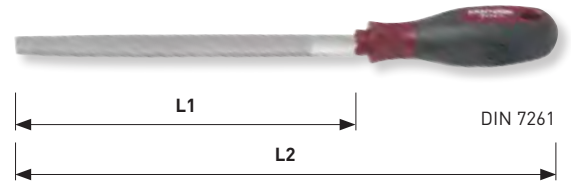
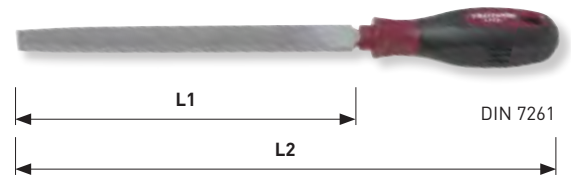

Workshop file set

second cut, with 2-component handles

Juego de limas

de corte semisuave, con mango bimaterial

Conjunto de limas

meio-murças, com cabos bi-matérias

Art.
4320

Art. 4320-1
Art. 4320-2
Art. 4320-3
Art. 4320-4
Art. 4320-5



Needle file set

Juego de limas finas

Conjunto de limas de calado

Art.	L1 mm
4321	165

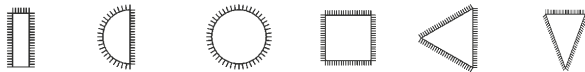

Stainless steel wire brush

V2A, 4 rows

Cepillo metálico

V2A, 4 filas de puas

Escova arame aço

V2A, 4 filas de puas y mango de haya

Art.	L1 mm
4325	260

Stainless steel wire brush

V2A, beech handle, 4-row

Cepillo metálico

V2A, 4 filas de puas

Escova arame aço

V2A, com 4 filas, cabo madeira

Art.	L1 mm
4326	290

T12 5
PCS

ERGOKRAFT

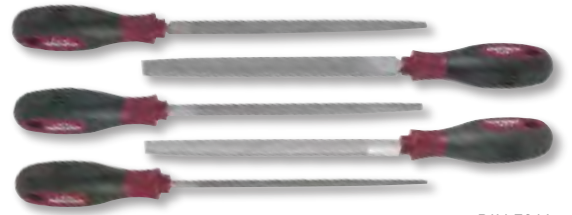

DIN 7261

T12 6
PCS

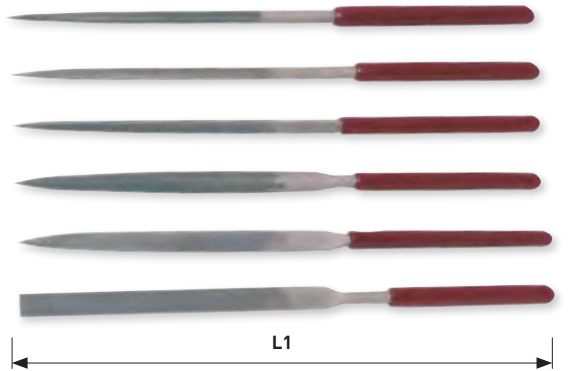

inox

ERGOKRAFT



inox

4x15





Engineer's security hammer

black painted head, with polished faces, steel handle protection sleeve, double cambered, smooth lacquered American hickory hard wood handle. Safely connected head and handle with steel wedge and epoxy-safety-bonding.

Martillo de seguridad tipo alemán

cabeza acabado negro, con caras pulidas, protección en acero, mango tipo Hickory en madera dura lacada.

Fijación duradera del mango por cuña de acero y cola epoxi de seguridad.

Martelo de segurança tipo alemão

cabeça lacada a preto, com faces polidas, punho com protecção em aço, fabricado em noqueira pintado e envernizado.

Fixação permanente do cabo e da cabeça por cunhas de aço e cola epóxi de segurança.

Art.	g	L1 mm	L2 mm	L3 mm
2301	100	82	15	262
2302	200	95	19	282
2303	300	105	23	302
2304	400	112	25	312
2305	500	118	27	322
2308	800	130	33	343
2310	1000	135	36	362
2315	1500	145	42	382

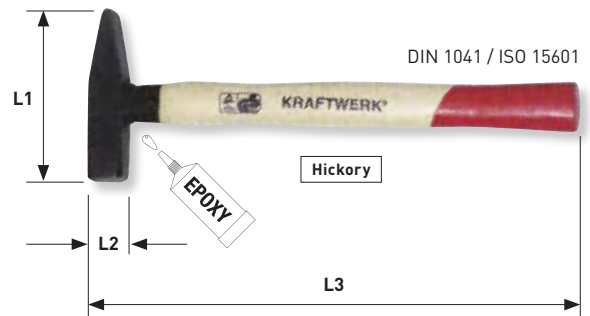

Engineer's security hammer

black painted head, with polished faces, handle protection sleeve, shockproof 2-component fiberglass handle. Safely connected head and handle with steel wedge and epoxy-safety-bonding.

Martillo de seguridad tipo alemán

cabeza acabado negro, con caras pulidas, protección en acero, mango resistente con 2 componentes de fibra de vidrio. Fijación duradera del mango por cuña de acero y cola epoxi de seguridad.

Martelo de segurança tipo alemão

cabeça lacada a preto, com faces polidas, punho com protecção em aço, cabo em fibra de vidro bimatéria resistente ao choque.

Fixação permanente do cabo e da cabeça por cunhas de aço e cola epóxi de segurança.

Art.	g	L1 mm	L2 mm	L3 mm
2385	300	105	23	300
2387	500	118	27	315

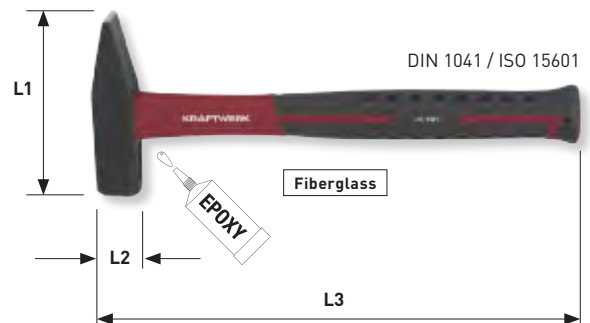

Security stoning hammer

black painted head, with polished faces, handle protection sleeve, shockproof 2-component fiberglass handle. Safely connected head and handle with steel wedge and epoxy-safety-bonding.

Maceta de seguridad

cabeça acabado negro, com caras polidas, proteção em aço, mango resistente com 2 componentes de fibra de vidro. Fijación duradera del mango por cuña de acero y cola epoxi de seguridad.

Marreta de mão de segurança

cabeça lacada a preto, com faces polidas, punho com protecção em aço, cabo em fibra de vidro bimatéria resistente ao choque. Fixação permanente do cabo e da cabeça por cunhas de aço e cola epóxi de segurança.

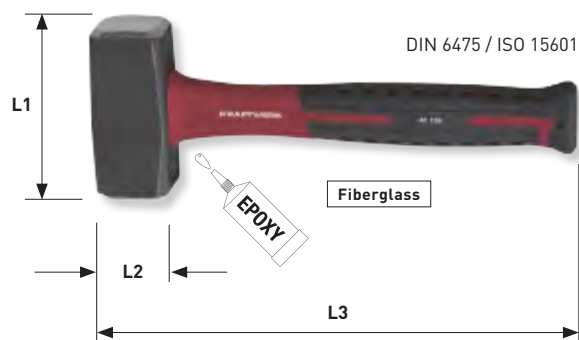

Art.	g	L1 mm	L2 mm	L3 mm
2390	1000	95	40	260
2392	1250	100	43	260
2395	1500	110	45	280

German engineer's full steel body hammer

undestroyable, with ergonomic 2 component handle

Martillo de seguridad tipo alemán en acero

indestructible, mango ergonómico bimatériau con revestimiento anti-deslizante

Martelo de uma única peça de aço tipo alemão

indestructível, com punho ergonómico em bimatéria

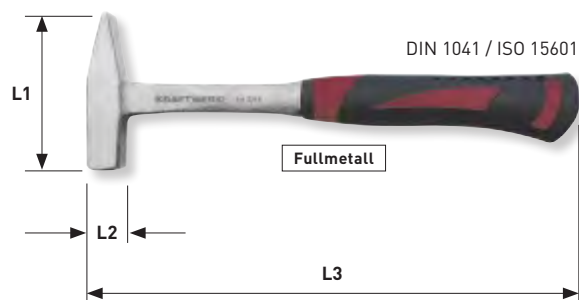

Art.	g	L1 mm	L2 mm	L3 mm
2319	500	118	27	330



French type engineer's hammer

black painted head, with polished faces, double cambered, smooth lacquered American hickory hard wood handle. Safely connected head and handle with steel wedge and epoxy-safety-bonding.

Martillo tipo francés

cabeza acabado negro, con caras pulidas, mango tipo Hickory en madera dura lacada. Fijación duradera del mango por cuña de acero y cola epoxi de seguridad.

Martelo tipo francês

cabeça lacada a preto, com faces polidas, punho com protecção em aço, fabricado em noqueira pintado e envernizado. Fixação permanente do cabo e da cabeça por cunhas de aço e cola epóxi de segurança.

Art.	g	L1 mm	L2 mm	L3 mm
2354	250	82	26	265
2355	300	86	28	280

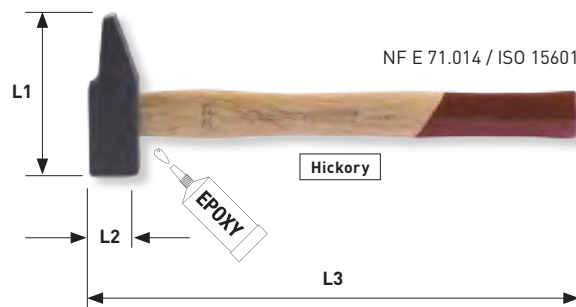

French type engineer's hammer

black painted head, with polished faces, handle protection sleeve, shockproof 2-component fiberglass handle. Safely connected head and handle with steel wedge and epoxy-safety-bonding.

Martillo tipo francés

cabeza acabado negro, con caras pulidas, protección en acero, mango resistente con 2 componentes de fibra de vidrio. Fijación duradera del mango por cuña de acero y cola epoxi de seguridad.

Martelo tipo francês

cabeça lacada a preto, com faces polidas, punho com protecção em aço, cabo em fibra de vidro bimatéria resistente ao choque. Fixação permanente do cabo e da cabeça por cunhas de aço e cola epóxi de segurança.

Art.	g	L1 mm	L2 mm	L3 mm
2376	400	94	30	307
2378	630	104	36	325
2380	860	110	40	362
2381	1000	118	42	362
2383	1600	140	50	374

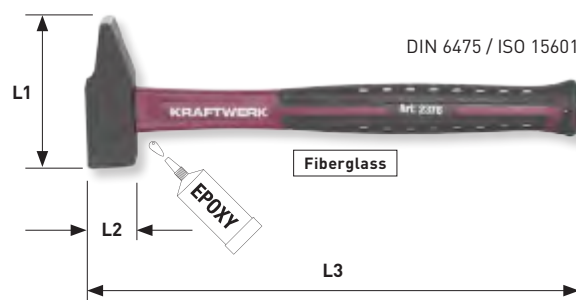

Security stoning hammer

black painted head, with polished faces, steel handle protection sleeve, smooth lacquered American hickory hard wood handle. Safely connected head and handle with steel wedge and epoxy-safety-bonding.

Maceta de seguridad

cabeza acabado negro, con caras pulidas, protección en acero, mango tipo Hickory en madera dura lacada. Fijación duradera del mango por cuña de acero y cola epoxi de seguridad.

Marreta de mão de segurança

cabeça lacada a preto, com faces polidas, punho com proteção em aço, fabricado em nogueira americana dura lacado. Fixação permanente do cabo e da cabeça por cunhas de aço e cola epóxi de segurança.

Art.	g	L1 mm	L2 mm	L3 mm
2339	800	92	37	260
2340	1000	95	40	260
2342	1250	100	43	260
2345	1500	110	45	280

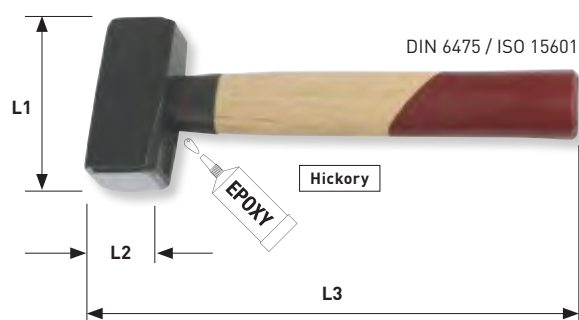

English type ballpein engineer's hammer

black painted head, with polished faces, smooth lacquered American hickory hard wood handle. Safely connected head and handle with steel wedge and epoxy-safety-bonding.

Martillo de cabeza redonda y boca esférica

cabeza acabado negro, con caras pulidas, mango tipo Hickory en madera dura lacada. Fijación duradera del mango por cuña de acero y cola epoxi de seguridad.

Martelo de bola

cabeça lacada a preto, com faces polidas, fabricado em nogueira americana dura lacado. Fixação permanente do cabo e da cabeça por cunhas de aço e cola epóxi de segurança.

Art.	g	L1 mm	L2 mm	L3 mm
2351	1130 / 40oz	137	40	400
2352	1360 / 48oz	147	42	400

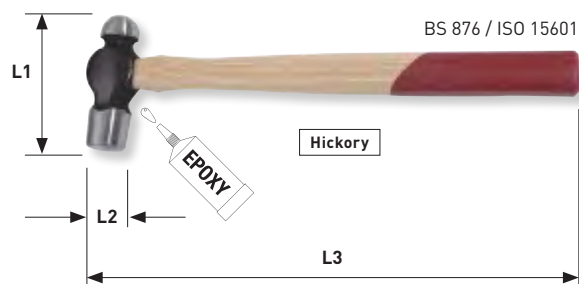

French type claw hammer

black painted head, with polished faces, shockproof 2-component fiberglass handle. Safely connected head and handle with steel wedge and epoxy-safety-bonding.

Martillo de boca sacaclavos, modelo francés

cabeza acabado negro, con caras pulidas, mango resistente con 2 componentes de fibra de vidrio. Fijación duradera del mango por cuña de acero y cola epoxi de seguridad.

Martelo de orelhas, tipo francês

cabeça lacada a preto, com faces polidas, cabo em fibra de vidro bimatéria resistente ao choque. Fixação permanente do cabo e da cabeça por cunhas de aço e cola epóxi de segurança.

Art.	g	L1 mm	L2 mm	L3 mm
2366	600	140	27	320

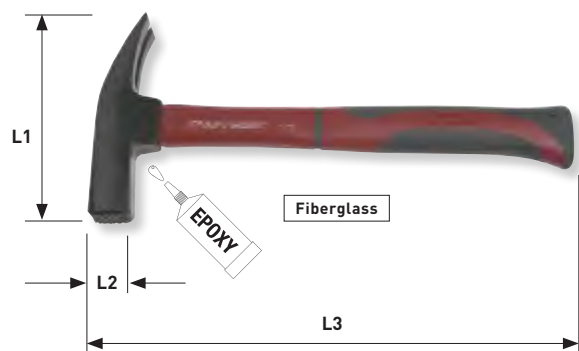

American type claw hammer

with polished head, shockproof 2-component fiberglass handle. Safely connected head and handle with steel wedge and epoxy-safety-bonding.

Martillo de uña, modelo americano

cabeza acabado negro, con caras pulidas, mango resistente con 2 componentes de fibra de vidrio. Fijación duradera del mango por cuña de acero y cola epoxi de seguridad.

Martelo de orelhas, tipo americano

cabeça polida, cabo em fibra de vidro bimatéria resistente ao choque. Fixação permanente do cabo e da cabeça por cunhas de aço e cola epóxi de segurança.

Art.	g	L1 mm	L2 mm	L3 mm
2368	450	132	29	320

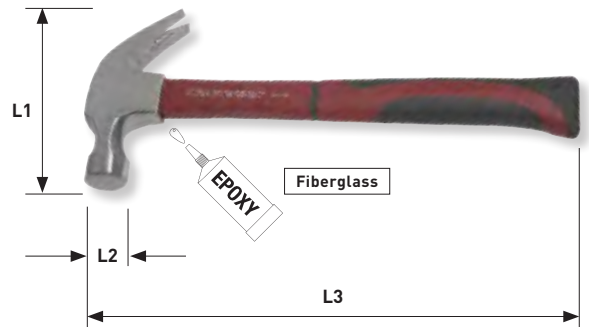

Soft-faced hammer with interchangeable heads

in nylon and urethane, smooth lacquered American hickory hard wood handle. Safely connected head and handle with steel wedge and epoxy-safety-bonding.

Maza con cabezas intercambiables plásticas

en nylon duro y uretano, mango tipo Hickory en madera dura lacada. Fijación duradera del mango por cuña de acero y cola epoxi de seguridad.

Martelo com batentes em plástico

em nylon e poliuretano, cabo lacado em nogueira americana dura. Fixação permanente do cabo e da cabeça por cunhas de aço e cola epóxi de segurança.

Art.	g	L1 mm	L2 mm	L3 mm
2336	360	98	35	305

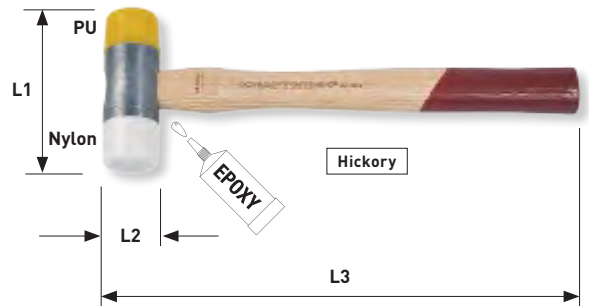

Replacement nylon hammer head

for soft-faced hammer 2336

Cabeza de recambio en nylon

para maza 2336

Batente em nylon

para martelo 2336

Art.	g	L1 mm	L2 mm
2336NY	55	24	35



Replacement urethane hammer head

for soft-faced hammer 2336

Cabeza de recambio en uretano

para maza 2336

Batente em poliuretano

para martelo 2336

Art.	g	L1 mm	L2 mm
2336PU	55	24	35

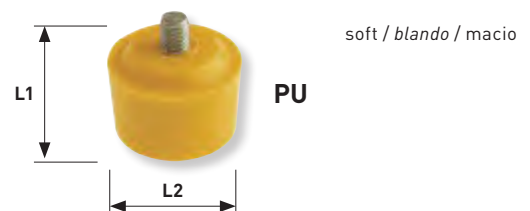

Carpenter's roofing hammer

black painted head, with magnetic nailholder, shockproof fiberglass handle with ergonomic safety rubber grip.

Martillo de encofrador

acabado negro, con sujeta tornillos imantado, con mango en fibra de vidrio y empuñadura de seguridad ergonómica en goma.

Martelo de carpinteiro

cabeça lacada a preto, com porta pregos magnético, cabo em fibra de vidro e punho de borracha ergonómico de segurança.

Art.	 g	L mm
2320	600	325



Plasterer's hatchet

painted head, with nail puller, hardened tubular steel handle with ergonomic safety rubber grip.

Hacha

acabado negro, con extractor de clavos, con mango de tubo de acero y empuñadura de seguridad ergonómica en goma.

Machado

cabeça lacada, com saca pregos, cabo em tubo de aço e punho de borracha ergonómico de segurança.

Art.	 g	L mm
2323	600	315

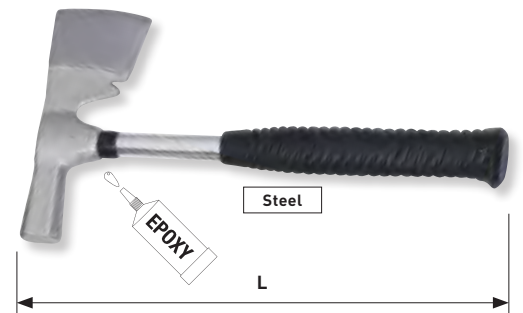

Pin punch

mirror polished

Botador cilíndrico

pulido brillante

Punção cilíndrico

polido brilhante

Art.	 mm	L mm
3350-2	2	115
3350-3	3	125
3350-4	4	150
3350-5	5	165
3350-6	6	180
3350-8	8	180

CrMo



Pin punch set

mirror polished, with tool-holder

Juego de botadores cilíndricos

pulidos brillante, con portaherramientas

Jogo de punções cilíndricas

polidos, com porta-ferramentas

Art.	∅ mm		L mm
3350	2-3-4-5-6-8		115-125-150-165-180-180

Art. 3350-2	2 mm
Art. 3350-3	3 mm
Art. 3350-4	4 mm
Art. 3350-5	5 mm
Art. 3350-6	6 mm
Art. 3350-8	8 mm

CrMo

**6
PCS**



DIN 6450 Form C

Pin punch

stove-enamelled

Botador cilíndrico

pintado al horno

Punção cilíndrico

termoesmaltado

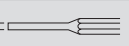
Art.	∅ mm		L mm
1350-2	2		115
1350-3	3		125
1350-4	4		150
1350-5	5		165
1350-6	6		180
1350-8	8		180

CrV



DIN 6450 Form C

Taper punch

mirror polished

Botador cónico

pulido brillante

Punção cónico

polido brilhante

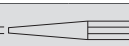
Art.	∅ mm		L mm
3355-2	2		120
3355-3	3		120
3355-4	4		120
3355-5	5		120
3355-6	6		120

CrMo



DIN 6458

Taper punch set

mirror polished, with tool-holder

Juego de botadores cónicos

pulidos brillante, con portaherramientas

Jogo de punções cónicas

polidos, com porta-ferramentas

Art.	∅ mm		L mm
3355	2-3-4-5-6		120

Art. 3355-2	2 mm
Art. 3355-3	3 mm
Art. 3355-4	4 mm
Art. 3355-5	5 mm
Art. 3355-6	6 mm

CrMo

5
PCS



DIN 6458

Center punch

mirror polished

Granete

pulido brillante

Punção bico

polido brilhante

Art.	∅ mm		L mm
3358-1	3		100
3358-2	4		120

CrMo



DIN 7250

Cold chisel, eight point

mirror polished

Cortafrío, octágono

pulido brillante

Escopro plano, octógono

polido brilhante

Art.	L1 mm	L2 mm
3365-12	12	130
3365-18	18	165

CrMo



DIN 6453

Cold chisel

stove-enamelled

Cortafrío

pintado al horno

Escopro plano

termoesmaltado

Art.	B mm	L mm
3380-18	18	125
3380-22	22	155

CrV



DIN 6451/53

Cape chisel, eight point

mirror polished

Buril, octágono

pulido brillante

Buril, octógono

polido brilhante

Art.	L1 mm	L2 mm
3368-5	5	130
3368-7	7	165

CrMo



Pin-, taper punch and chisel set

mirror polished, with tool-holder

Juego de cortafríos, botadores y buriles

polidos, con portaherramientas

Jogo de punções, escopro e buril

polidos, com porta-ferramentas

Art.
3370

	Art. 3350-4	4 mm
	Art. 3355-3	3 mm
	Art. 3358-2	4 mm
	Art. 3365-12	12 mm
	Art. 3368-5	5 mm

CrMo **5 PCS**



Pin-, taper punch and chisel set

mirror polished, with metallic tool-holder

Juego de cortafríos, botadores y buriles

polidos, con portaherramientas metálico

Jogo de punções, escopro e buril

polidos, com porta-ferramentas metálico

Art.
3374

	Art. 3350-2	2 mm		Art. 3355-2	2 mm
	Art. 3350-3	3 mm		Art. 3355-3	3 mm
	Art. 3350-4	4 mm		Art. 3355-4	4 mm
	Art. 3350-5	5 mm		Art. 3355-5	5 mm
	Art. 3350-6	6 mm		Art. 3355-6	6 mm
	Art. 3350-8	8 mm		Art. 3365-12	12 mm
	Art. 3358-1	3 mm		Art. 3365-18	18 mm
	Art. 3358-2	4 mm		Art. 3368-5	5 mm
				Art. 3368-7	7 mm

CrMo **17 PCS**



Automatic center punch
Puntero automático
Punção bico automático

Art.	L mm
3359	132

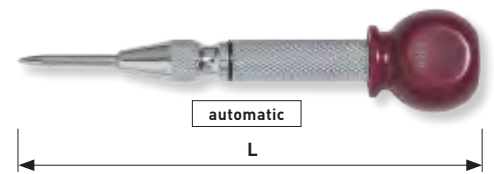

Spare tip and spring

for automatic center punch 3359

Punto y resorte de recambio

para puntero automático 3359

Ponta e mola

para punção automático 3359

Art.	L mm
3359E	-



Parallel steel bench vise

drop forged, with swivel base and tubular clamping jaw, exchangeable hardened clamping jaws, forward opening, with anvil and beak, black enameled. Jaws, guideway and anvil grinded and hardened.

Tornillo de banco paralelo en acero

forjado, con pie giratorio y mordazas para tubos, mordazas de acero intercambiables, abertura hacia adelante, con el yunque y el cuerno, pintado de negro. Mordazas, tobogán y yunque afilado y endurecido.

Torno de bancada paralelo em aço

forjado, com pé giratório e mandíbulas para tubos, mandíbulas de aço intercambiáveis, abrindo para a frente, com bigorna e bico, lacado a preto. As mandíbulas, o trilho guia e a bigorna afiados e endurecidos.



Art.	L1 mm	L2 mm	L3 mm	g
2961	100	120	65	7.5
2962	125	140	70	11
2963	150	170	80	14.5
2964	200	200	90	20.5

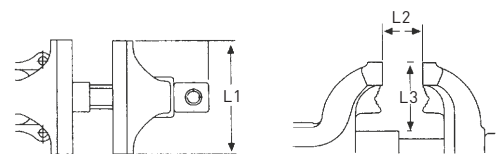

Spare clamping jaws

for parallel steel bench vise 2961

Mordazas de recambio

para tornillo de banco paralelo en acero 2961

Mandíbulas substituíveis

para torno de bancada paralelo em aço 2961

Art.
2961E
2962E
2963E
2964E



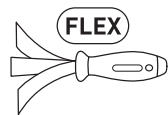
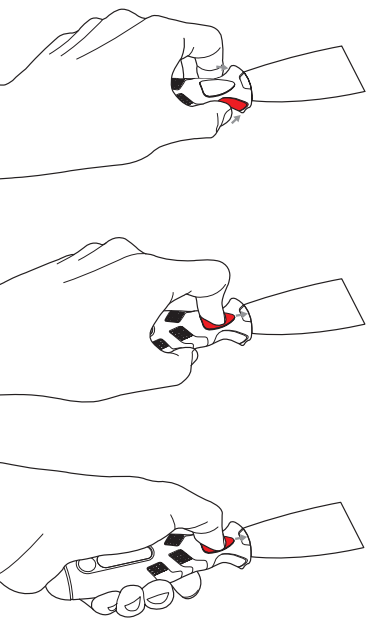

Universal spatula

- flexible blade made of stainless steel, hardened and mirror polished
- bi-material soft grip handle with anti-slip grip



Espátula universal

- lama flexible en acero inoxidable, reforzada y con acabado pulido brillante
- mango bimatériau antideslizante

Espátula universal

- lâmina flexível em inox, reforçada e polida
- cabo em bimatéria anti-derrapante

Art.	B mm	L1 mm	L2 mm
3331-032	32	105	240
3331-050	50	105	245
3331-063	63	105	245
3331-075	75	105	245
3331-100	100	105	245
3331-125	125	105	245



Universal spatula set

- flexible blades made of stainless steel, hardened and mirror polished
- bi-material soft grip handles with anti-slip grips



Juego de espátulas universales

- lamas flexibles en acero inoxidable, reforzadas y con acabado pulido brillante
- mangos bimatériau antideslizantes

Jogo de espátulas universais

- lâminas flexíveis em inox, reforçadas e polidas
- cabos em bimatéria anti-derrapante

Art. 3331-032 32 mm
Art. 3331-050 50 mm
Art. 3331-075 75 mm

Art.	B mm
3335	32 - 50 - 75



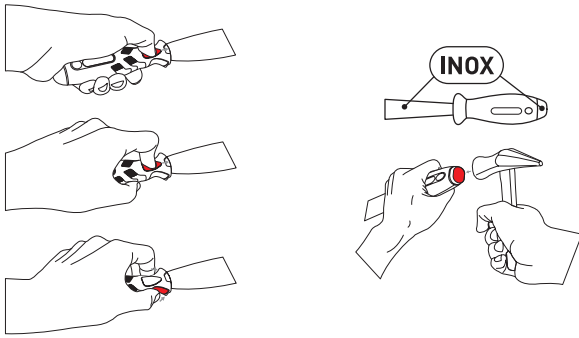

Striking scraper and chisel

- solid blade made of stainless steel, hardened and mirror polished.
- bi-material soft grip handle with non-slip grip indentations and stainless steel striking cap

Espátula-rascador

- lamas sólidas en acero inoxidable, reforzadas, con acabado pulido brillante
- mango bimataterial antideslizante y capuchón de acero inoxidable

Raspador direito

- lâmina sólida feita aço inox, reforçada, e polida.
- punho em bimatéria anti-derrapante e zona de impacto em inox

Art.	B mm	L1 mm	L2 mm
3332-032	32	105	240
3332-075	75	105	245

Striking offset scraper and chisel

- solid blade made of stainless steel, hardened and mirror polished.
- bi-material soft grip handle with non-slip grip indentations and stainless steel striking cap

Espátula-rascador, angular

- lamas sólidas en acero inoxidable, reforzadas, con acabado pulido brillante
- mango bimataterial antideslizante y capuchón de acero inoxidable

Raspador curvo

- lâmina sólida feita aço inox, reforçada, e polida.
- punho em bimatéria anti-derrapante e zona de impacto em inox

Art.	B mm	L1 mm	L2 mm
3333-032	32	98	235
3333-075	75	110	240

Striking scraper and chisel set

- solid blades made of stainless steel, hardened and mirror polished
- bi-material soft grip handles with non-slip grip indentations and stainless steel striking caps

Juego de espátulas rascadoras

- lamas sólidas en acero inoxidable, reforzadas, con acabado pulido brillante
- mangos bimataterial antideslizante y capuchones de acero inoxidable

Jogo de espátulas

- lâminas sólidas feitas em aço inox, reforçada e polida
- punhos em bimatéria anti-derrapante e zonas de impacto em inox

Art.	B mm
3336	32/15° - 32 - 75



inox



inox



inox

3
PCS





Steel pocket measuring tape

small and handy, with key-chain

Flexómetro llavero

pequeño y práctico con portallaves

Fita métrica

pequena e prática com porta chaves

Art.	L/M →	B/mm ↑	↕ mm
4701-0206	2 m x 6 mm	6	47 x 46 x 12



Measuring tape

Chromed ABS casing with rubber grip. Yellow lacquered, nylon coated steel blade with mm-graduation. Blade-lock. Removeable belt clip. Precision class II.

Flexómetro

Caja cromada en ABS, con protección en caucho. Cinta en acero con revestimiento en nylon, escala en mm, lacado en amarillo. Bloqueo de cinta. Clip para cinturón removible. Clase precisión II.

Fita métrica

Caixa em ABS cromado com protecção de borracha. Fita em aço revestida em nylon, graduação impressa em mm. Bloqueio da fita. Gancho com dois imans. Clip de cinto removível. Classe de precisão II.



Art.	L/M →	B/mm ↑	↕ mm
4701-0316	3	16	61 x 53 x 25
4701-0519	5	19	71 x 64 x 29



Measuring tape

Extra wide, shock absorbing tape measure, 2 sides labelled with mm-graduation, nylon coated. Big end hook with 2 magnets, solid ABS/rubber-housing.

Flexómetro de luxe

Extra largo protección anti-golpe, graduación en mm sobre las 2 caras, revestimiento en nylon. Gancho extralargo al final de la cinta con 2 imanes, carcasa sólida en ABS/caucho.

Fita métrica

Fita métrica extra larga, com protecção de impacto, numeração em ambos os lados em mm, revestimento em nylon. Gancho terminal grande com dois imans. Corpo em ABS/borracha.

Art.	L/M →	B/mm ↑	↕ mm
4706-0319	3	19	62 x 62 x 29
4706-0527	5	27	72 x 72 x 41
4706-0827	8	27	82 x 82 x 41



Measuring tape

Steel blade with auto-lock function and mm-graduation, ABS casing.

Flexómetro

Cinta metálica con graduación en mm, función de bloqueo automático y caja en ABS.

Fita métrica

Lâmina de aço com função de auto-bloqueio e numeração em mm. Corpo em ABS.

Art.	L/M	B/mm	mm
4706-0313	3	13	62 x 62 x 27

ABS



Long steel measuring tape

Fully closed ABS casing and solid rubber jacket. Yellow lacquered, nylon coated steel blade with mm- and cm-graduation. Quick blade-rewind by folding rewind crank on backside. Precision class II.

Cinta larga en acero

Caja sólida en ABS con protección en caucho. Cinta en acero con revestimiento en nylon, escala en mm y cm, lacado en amarillo. Recogida rápida de la cinta con manivela. Gancho con 2 imanes.

Fita métrica longa em aço

Caixa sólida em ABS e de borracha, lâmina em aço com revestimento nylon com escala em mm e cm. Rebobinagem rápida devido a manivela retrátil. Classe de precisão II.

Art.	L/M	B/mm	mm
4712-109.5	10	9.5	85 x 83 x 20

ABS



Long fibreglas measuring tape

Fully closed ABS casing. Yellow lacquered, unbreakable high quality fibreglas blade with cm-graduation. Quick blade-rewind by folding rewind crank on backside. Precision class III.

Cinta larga en fibra de vidrio

Estructura resistente en ABS. Cinta en fibra de vidrio irrompible, escala en cm, lacado en amarillo. Recogida rápida de la cinta con manivela. Clase precisión III.

Fita métrica longa em fibra de vidro

Caixa em ABS. Fita em fibra de vidro inquebrável de alta qualidade com graduação em cm. Rebobinagem rápida devido a manivela retrátil. Classe de precisão III.

Art.	L/M	B/mm	mm
4716-1013	10	13	114 x 113 x 20

ABS



Long steel measuring tape

Shockproof ABS frame. Yellow lacquered, nylon coated steel blade with mm- and cm-graduation. Quick blade-rewind by folding rewind crank on backside with 3:1 metal gear transmission. Precision class II.

Cinta larga en acero

Estructura en ABS resistente a golpes. Cinta en acero con revestimiento en nylon, escala en mm y cm, lacado en amarillo. Recogida rápida de la cinta con manivela de triple multiplicación. Clase precisión II.

Fita métrica longa em aço

Quadro em ABS resistente aos choques. Fita em aço revestida em nylon com graduação em mm e cm. Rebobinagem rápida devido a manivela retrátil. Classe de precisão II.

Art.	$\frac{L}{M}$	B/mm
4711-3013	30	13

ABS

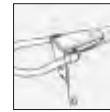

Steel ruler

Precision graduation in mm and 1/2 mm, flexible, stainless, antireflection treatment. Precision class II.

Regla acero

Graduación precisa en mm y 1/2 mm, flexible, inoxidable, tratamiento antirreflejo. Clase precisión II.

Régua de aço

Graduação precisa em mm e 1/2 mm, flexível, inoxidável, tratamento anti-reflexo. Classe de precisão II.

Art.	B/mm	L mm
2976	28	300

inox

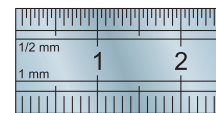
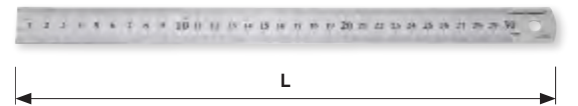

0.5 mm

1.0 mm

Precision steel square

without flange, ground

Escuadra lisa en acero

Sin reborde, rectificada

Esquadro simples em aço

sem rebordo, retificado

Art.	L1 mm	L2 mm
2978	100	70

inox

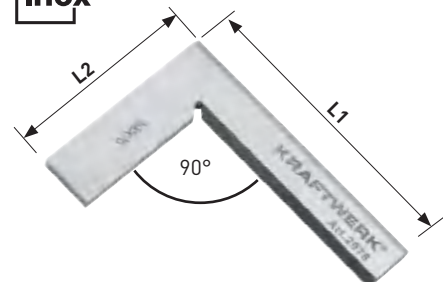

DIN 875

Vernier caliper

stainless steel, hardened fine grinded, with cross points, nonius and scale satin chromed, with locking screw, depth measuring 150 mm, in plastic case.

Calibre

en acero inoxidable, endurecido y rectificado, con puntos cruzados, nonio y escala cromado mate, tornillo de bloqueo, medición de profundidad 150 mm. En estuche de plástico.

Paquímetro

em aço inox, endurecido e retificado, com pontos cruzados, nónio y escala cromados mate, com parafuso de bloqueio, medida em profundidade 150 mm, em caixa.

Art.	$\frac{L}{M}$ mm	$\frac{L}{M}$ mm	L mm
2970	0-150 6"	0.05 1/128"	230

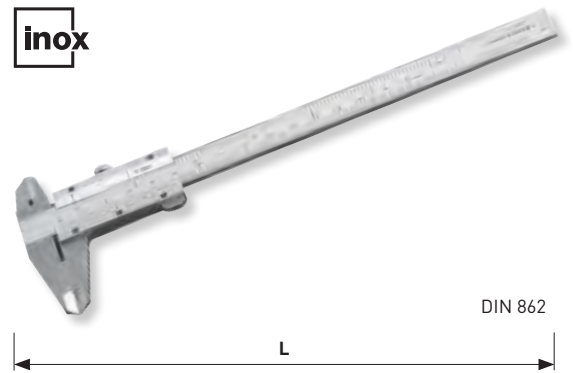

- 1 external measurement / medición externa / medição externa
- 2 internal measurement / medición interna / medição interna
- 3 depth measurement / medición de profundidad / medição de profundidade

Digital caliper

with locking screw, reading switchable mm - inch, 5-digit LCD-display, zero setting at any position, for external, internal and depth measuring. In plastic case.

Calibre digital

en acero inoxidable, con bloqueo mediante tornillo, lectura commutable mm - pulgadas, pantalla LCD de 5 dígitos, puesta a cero en cualquier posición, para medidas exteriores, interiores y de profundidad. En estuche de plástico.

Paquímetro digital

com parafuso de bloqueio, leitura comutável mm - polegadas, display LCD de 5 dígitos, ajuste do zero em qualquer posição, para medições de interiores e exteriores e de profundidade. Em caixa de plástico.

Art.	$\frac{L}{M}$ mm	$\frac{L}{M}$ mm	L mm
2972	0-150 6"	0.01 0.0005"	235

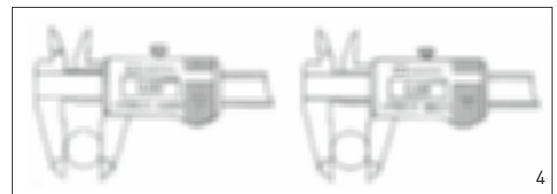
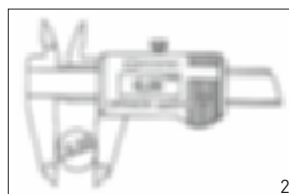
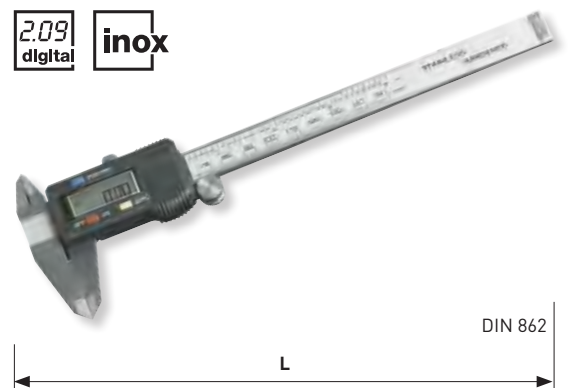

- 1 Measurements of internal dimensions
Medición de las dimensiones internas
Medição de dimensões internas
- 2 Measurements of external dimensions
Medición de las dimensiones externas
Medição de dimensões externas
- 3 Measurements of depth
Medición de la profundidad
Medição de profundidade
- 4 Differential method of measurement
(Application of zero setting)
Método diferencial de medición
(Aplicación de ajuste a cero)
Método diferencial de medição
(ajuste para zero em qualquer posição)
- 5 Measurement of steps
Medición de etapas
Medição das etapas

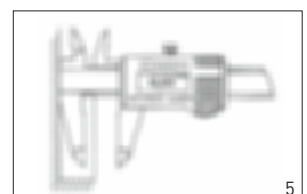

Outside micrometer

Measuring faces of hard metal, friction clutch and locking screw

Micrómetro exterior

Caras en metal duro, con fricción del embrague y tornillo de bloqueo

Micrómetro exterior

Faces em metal duro, com embreagem de fricção e parafuso de fixação

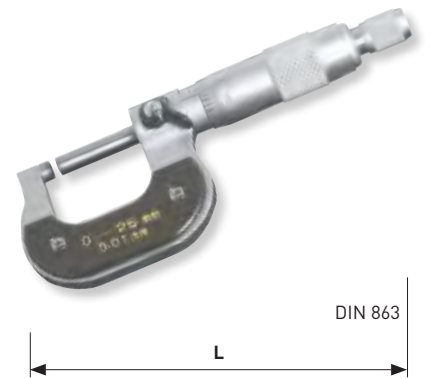

Art.	L/mm	mm	L mm
2975	0-25	0.01	135

Precision measuring tool set

- Digital caliper 150 mm/0-6"
- Outside micrometer 0-25 mm/0.01 mm
- Square 100 x 70 mm
- Steel ruler 150 mm

Juego de herramientas de medición

- Calibre digital 150 mm/0-6"
- Micrómetro exterior 0-25 mm/0.01 mm
- Escuadra 100 x 70 mm
- Regla acero 150 mm

Jogo de instrumentos de medida

- Paquímetro Digital 0-150 mm/0-6"
- Micrómetro de exteriores 0-25 mm/0.01 mm
- Esquadro 100 x 70 mm
- Régua semi-rígida inox 150 mm

2.09 digital 4 PCS



DIGITAL		Art.	Dimensions
		2972	150 mm x 0.01 mm / 6" x 0.0005"
		2975	0-25 mm x 0.01 mm
			150 mm x 19 mm
		2978	100 mm x 70 mm / 90°

Art.
2980

Steel protractor

satin chrome finish, with locking screw, for measuring the angular degrees of 0-180°

Medidor ángulos en acero

cromado satinado, con bloqueo mediante tornillo, para medir los grados de ángulo de 0 a 180°

Suta em aço

cromado mate, com parafuso de bloqueio, para medir ângulo de 0-180°

Art.	L mm	mm
2977	200	1 - 0-180°

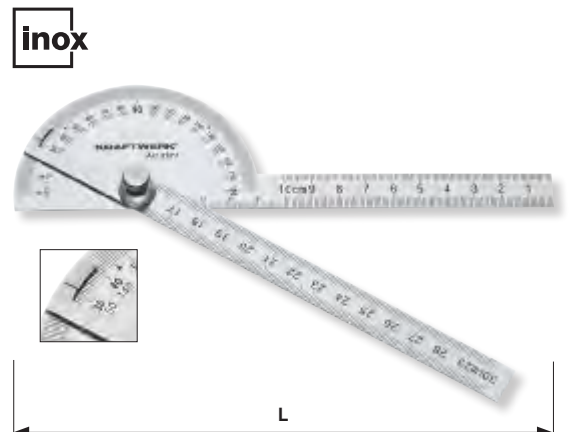

Electronic pocket digital level with 2 vials

Measures electronically angles and shows them on the digital display in degrees and percentages. Measurement range 0° to 90°, high resolution $\pm 0,1^\circ$, reading 0,1 degrees or percentage. Calibrating in seconds at the place and hold function. Shock resistant ABS polymer casing with magnetic aluminium base.

Nivel digital electrónico de bolsillo con 2 fiolas

Medida de ángulo electrónicamente y lectura digital en grados y porcentaje. Capacidad de 0°- 90°, precisión $\pm 0,1^\circ$, lectura gradual de 0,1 ó porcentaje. Calibrado rápido en segundos, botón de fijación. Resistente a golpes, carcasa en polímeros-ABS, base magnética en aluminio.

Nivel electrónico digital de bolso com 2 bolhas

Medida electrónica dos ângulos e mostra no display em graus e percentagem. Capacidade de medida 0° a 90°, alta resolução $\pm 0,1^\circ$ de precisão, leitura em 0,1 graus ou percentagem. Calibração em segundos e posição de espera. Feito em ABS resistente ao choque com base magnética em alumínio.



107 x 55 x 18 mm

Art.
2939

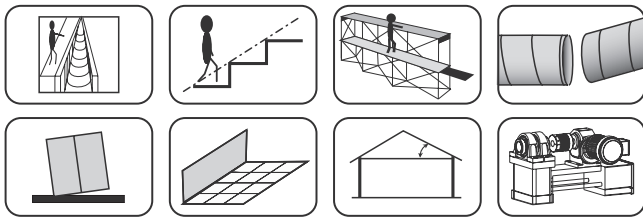

Torpedo level

with magnetic base and 3 vials

Nivel torpedo

con base magnética y 3 fiolas

Nível de Torpedo

com base magnética e 3 bolhas

Art.	L mm
3970	225



L

Feeler gauge set

Metric leaves of hardened spring steel, conical blade shape, with locking screw.

Juego de galgas

Hojas métricas de acero para muelles, forma de hoja cónica, con tornillo de bloqueo.

Jogo de apalpa folgas

Folhas de aço métricas com mola de forma cônica, com parafuso de bloqueio.

10
PCS

Art.	L mm	mm
2974	107	0.05-0.1-0.15-0.2-0.3-0.4-0.5-0.6-0.7-0.8

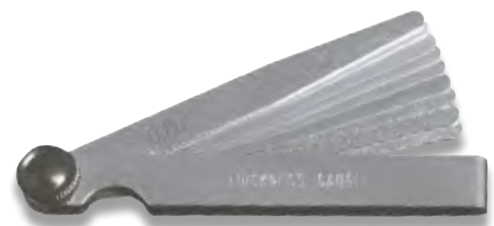





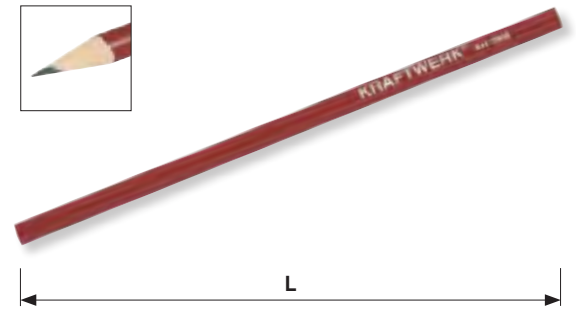

L

Craftsman pencil
Lápiz de carpintero
Lápis de Carpinteiro

Art.	L mm	
3966	175	144

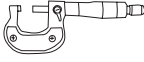

Measuring tool case
Estuche herramienta medición
Mala de ferramentas de medição

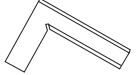
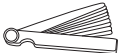
	Art. 2970	150 mm x 0.05 mm / 6" x 1/128"
	Art. 4701-0519	5 m x 19 mm
	Art. 2975	0-25 mm x 0.01 mm
	Art. 3196	L 130-630 mm, 2000 g
	Art. 4998	145 mm
	Art. 2976	300 mm x 28 mm
	Art. 2977	200 mm
	Art. 2978	100 mm x 70 mm
	Art. 2974	0.05-0.1-0.15-0.2-0.3-0.4-0.5-0.6-0.7-0.8 mm

9
PCS

COMPLETO



 421 x 200 x 68 mm

Art.
4900-12K

Magnifying glass with LED light

- 3 x magnification
- Very bright LED with intelligent IC for long battery life
- Non distorting high quality optical glass
- Ergonomic 2-components handle
- TPE rubber framing for extra protection

Lupa con luz LED

- 3x aumentos
- LED muy luminoso con IC inteligente para mejorar la vida de la pila
- No distorsiona, lente óptica de gran calidad
- Mango ergonómico bimatériau
- Marco de goma TPE para protección extra

Lupa com luz LED

- Ampliação 3 x
- LED branco com inteligência IC para uma longa vida da bateria
- Vidro óptico de grande qualidade sem distorção
- Cabo ergonómico em bimatéria
- Moldura em borracha TPE para uma protecção extra



ERGOKRAFT

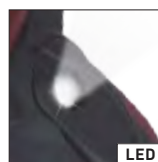
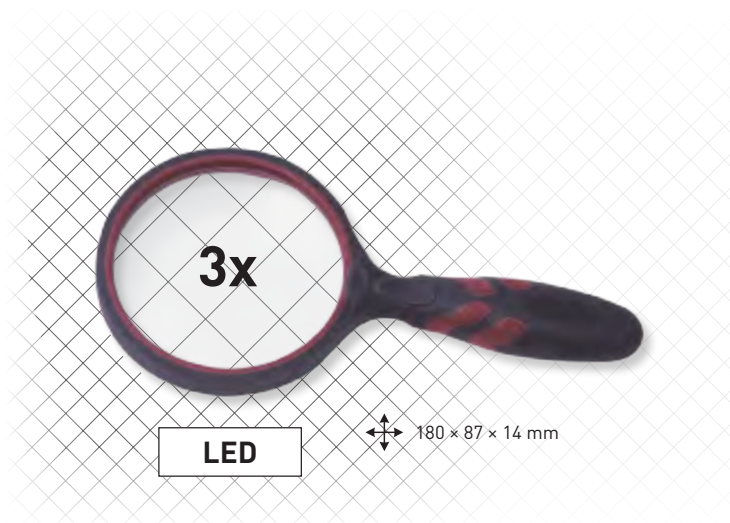

Art.
3341

LED lighted pocket magnifier

3 magnifications 3-5-7 x

Lupa de bolsillo con luz LED

3 niveles de aumento 3-5-7 x

Lupa de bolso com luz LED

3 ampliações 3-5-7 x



Art.
3342





Helicoidal twist drill

rollforged, cylindrical, short, right hand cutting, efficient, high concentricity, good chip removal

Broca helicoidal

laminada, cilíndrica, corta, corte a la derecha, de buen rendimiento, de alta concentricidad, buena evacuación de las virutas

Broca helicoidal

laminado, cilíndrico, curto, corte à direita, bom desempenho, alta concentricidade, boa remoção de aparas

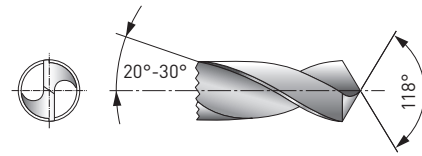

10
PCS

10 Pcs./pz./pz.

Art. 10010 - Art. 10080



5
PCS

5 Pcs./pz./pz.

Art. 10085 - Art. 10130



HSS

DIN 338 N / ISO 235

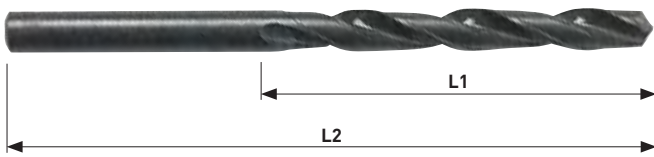

Art.	Ø mm	L1 mm	L2 mm
10010	1.0	12	34
10015	1.5	18	40
10020	2.0	24	49
10025	2.5	30	57
10030	3.0	33	61
10032	3.2	36	65
10033	3.3	36	65
10035	3.5	39	70
10040	4.0	43	75
10042	4.2	43	75
10045	4.5	47	80

Art.	Ø mm	L1 mm	L2 mm
10048	4.8	53	86
10050	5.0	52	86
10055	5.5	57	93
10060	6.0	57	93
10065	6.5	63	101
10068	6.8	69	109
10070	7.0	69	109
10075	7.5	69	109
10080	8.0	75	117
10085	8.5	75	117
10090	9.0	81	125

Art.	Ø mm	L1 mm	L2 mm
10095	9.5	81	125
10100	10.0	87	133
10102	10.2	87	133
10105	10.5	87	133
10110	11.0	94	142
10115	11.5	94	142
10120	12.0	101	151
10125	12.5	101	151
10130	13.0	101	151

Twist drill set

rollforged, cylindrical, short, right hand cutting, efficient, high concentricity, good chip removal

Juego de brocas helicoidales

laminadas, cilíndricas, cortas, corte a la derecha, de buen rendimiento, de alta concentricidad, buena evacuación de las virutas

Jogo de brocas helicoidal

laminadas, cilíndricas, curtas, corte à direita, bom desempenho, alta concentricidade, boa remoção de aparas

Art.	Ø mm
10903	2.0-2.5-3.0-3.5-4.0-4.5-5.0 5.5-6.0-6.5-7.0-7.5-8.0

13
PCS

HSS

DIN 338 N / ISO 235



Twist drill set

rollforged, cylindrical, short, right hand cutting, efficient, high concentricity, good chip removal

Juego de brocas helicoidales

laminadas, cilíndricas, cortas, corte a la derecha, de buen rendimiento, de alta concentricidad, buena evacuación de las virutas

Jogo de brocas helicoidais

laminadas, cilíndricas, curtas, corte à direita, bom desempenho, alta concentricidade, boa remoção de aparas

Art.	Ø mm
10900	1.0-1.5-2.0-2.5-3.0-3.5-4.0-4.5-5.0-5.5 6.0-6.5-7.0-7.5-8.0-8.5-9.0-9.5-10.0

19
PCS

HSS

DIN 338 N / ISO 235



Twist drill set

rollforged, cylindrical, short, right hand cutting, efficient, high concentricity, good chip removal

Juego de brocas helicoidales

laminadas, cilíndricas, cortas, corte a la derecha, de buen rendimiento, de alta concentricidad, buena evacuación de las virutas

Jogo de brocas helicoidais

laminadas, cilíndricas, curtas, corte à direita, bom desempenho, alta concentricidade, boa remoção de aparas

Art.	Ø mm
10906	1.0-1.5-2.0-2.5-3.0-3.5-4.0-4.5-5.0-5.5-6.0-6.5-7.0 7.5-8.0-8.5-9.0-9.5-10.0-10.5-11.0-11.5-12.0-12.5-13.0

25
PCS

HSS

DIN 338 N / ISO 235



Twist drill case

rollforged, cylindrical, short, right hand cutting, efficient, high concentricity, good chip removal

Estuche de brocas helicoidales

laminadas, cilíndricas, cortas, corte a la derecha, de buen rendimiento, de alta concentricidad, buena evacuación de las virutas

Mala de brocas helicoidais

laminadas, cilíndricas, curtas, corte à direita, bom desempenho, alta concentricidade, boa remoção de aparas

170
PCS

HSS

DIN 338 N / ISO 235



Art.	Pcs.	Ø mm
	10	1.0-1.5-2.0-2.5-3.0-3.5-4.0-4.5
10910	10	5.0-5.5-6.0-6.5-7.0-7.5-8.0
	5	8.5-9.0-9.5-10.0

Twist drill magazin, empty

Estuche vacío para brocas

Mala vazia para brocas



Art.
10910K

Helicoidal twist drill

ground, cylindrical, short, right hand cutting, split point from $\varnothing 3$ mm, efficient, high concentricity, good chip removal

Broca helicoidal

rectificada, cilíndrica, corta, corte a la derecha, centrado automático a partir de $\varnothing 3$ mm, de buen rendimiento, de alta concentricidad, buena evacuación de las virutas

Broca helicoidal

rectificada, cilíndrica, curta, corte à direita, centragem automática a partir de $\varnothing 3$ mm, bom desempenho, alta concentricidade, boa remoção de aparas

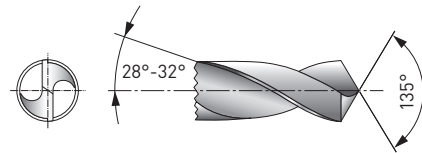

ground / rectificada / rectificada

HSS-G

DIN 338 N / ISO 235

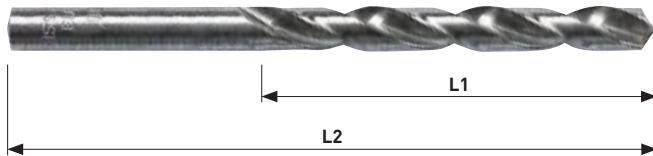

10
PCS

10 pcs./pz./pz.

Art. 11010 - Art. 11080



5
PCS

5 pcs./pz./pz.

Art. 11081 - Art. 11130



Art.	\varnothing mm	L1 mm	L2 mm
11010	1.0	12	34
11011	1.1	14	36
11012	1.2	16	38
11013	1.3	16	38
11014	1.4	18	40
11015	1.5	18	40
11016	1.6	20	43
11017	1.7	20	43
11018	1.8	22	46
11019	1.9	22	46
11020	2.0	24	49
11021	2.1	24	49
11022	2.2	27	53
11023	2.3	27	53
11024	2.4	30	57
11025	2.5	30	57
11026	2.6	30	57
11027	2.7	33	61
11028	2.8	33	61
11029	2.9	33	61
11030	3.0	33	61
11031	3.1	36	65
11032	3.2	33	65
11033	3.3	33	65
11034	3.4	39	70
11035	3.5	39	70
11036	3.6	39	70
11037	3.7	39	70
11038	3.8	43	75
11039	3.9	43	75
11040	4.0	43	75
11041	4.1	43	75
11042	4.2	43	75

Art.	\varnothing mm	L1 mm	L2 mm
11043	4.3	47	80
11044	4.4	47	80
11045	4.5	47	80
11046	4.6	47	80
11047	4.7	47	80
11048	4.8	52	86
11049	4.9	52	86
11050	5.0	52	86
11051	5.1	52	86
11052	5.2	52	86
11053	5.3	52	86
11054	5.4	57	93
11055	5.5	57	93
11056	5.6	57	93
11057	5.7	57	93
11058	5.8	57	93
11059	5.9	57	93
11060	6.0	57	93
11061	6.1	63	101
11062	6.2	63	101
11063	6.3	63	101
11064	6.4	63	101
11065	6.5	63	101
11066	6.6	63	101
11067	6.7	63	101
11068	6.8	69	109
11069	6.9	69	109
11070	7.0	69	109
11071	7.1	69	109
11072	7.2	69	109
11073	7.3	69	109
11074	7.4	69	109
11075	7.5	69	109

Art.	\varnothing mm	L1 mm	L2 mm
11076	7.6	75	117
11077	7.7	75	117
11078	7.8	75	117
11079	7.9	75	117
11080	8.0	75	117
11081	8.1	75	117
11082	8.2	75	117
11083	8.3	75	117
11084	8.4	75	117
11085	8.5	75	117
11086	8.6	81	125
11087	8.7	81	125
11088	8.8	81	125
11089	8.9	81	125
11090	9.0	81	125
11091	9.1	81	125
11092	9.2	81	125
11093	9.3	81	125
11094	9.4	81	125
11095	9.5	81	125
11096	9.6	81	125
11097	9.7	87	133
11098	9.8	87	133
11099	9.9	87	133
11100	10.0	87	133
11102	10.2	87	133
11105	10.5	87	133
11110	11.0	94	142
11115	11.5	94	142
11120	12.0	101	151
11125	12.5	101	151
11130	13.0	101	151

Helicoidal twist drill set

ground, cylindrical, short, right hand cutting, split point from Ø 3 mm, efficient, high concentricity, good chip removal

Juego de brocas helicoidales

rectificadas, cilíndricas, cortas, corte a la derecha, centrado automático a partir de Ø 3 mm, de buen rendimiento, de alta concentricidad, buena evacuación de las virutas

Jogo de brocas helicoidais

rectificadas, cilíndricas, curtas, corte à direita, centragem automática a partir de Ø 3 mm, bom desempenho, alta concentricidade, boa remoção de aparas

Art.	Ø mm
11904	1.0-1.5-2.0-2.5-3.0-3.5-4.0-4.5-5.0-5.5 6.0-6.5-7.0-7.5-8.0-8.5-9.0-9.5-10.0

Helicoidal twist drill set

ground, cylindrical, short, right hand cutting, split point from Ø 3 mm, efficient, high concentricity, good chip removal

Juego de brocas helicoidales

rectificadas, cilíndricas, cortas, corte a la derecha, centrado automático a partir de Ø 3 mm, de buen rendimiento, de alta concentricidad, buena evacuación de las virutas

Jogo de brocas helicoidais

rectificadas, cilíndricas, curtas, corte à direita, centragem automática a partir de Ø 3 mm, bom desempenho, alta concentricidade, boa remoção de aparas

Art.	Ø mm
11905	1.0-1.5-2.0-2.5-3.0-3.5-4.0-4.5-5.0-5.5-6.0-6.5-7.0 7.5-8.0-8.5-9.0-9.5-10.0-10.5-11.0-11.5-12.0-12.5-13.0

Helicoidal twist drill case

ground, cylindrical, short, right hand cutting, split point from Ø 3 mm, efficient, high concentricity, good chip removal

Estuche de brocas helicoidales

rectificadas, cilíndricas, cortas, corte a la derecha, centrado automático a partir de Ø 3 mm, de buen rendimiento, de alta concentricidad, buena evacuación de las virutas

Mala de brocas helicoidais

rectificadas, cilíndricas, curtas, corte à direita, centragem automática a partir de Ø 3 mm, bom desempenho, alta concentricidade, boa remoção de aparas

Art.	Pcs.	Ø mm
11910	10	1.0-1.5-2.0-2.5-3.0-3.5-4.0-4.5
	10	5.0-5.5-6.0-6.5-7.0-7.5-8.0
	5	8.5-9.0-9.5-10.0

19
PCS

HSS-G

DIN 338 N / ISO 235



ground / rectificadas / rectificadas

25
PCS

HSS-G

DIN 338 N / ISO 235



ground / rectificadas / rectificadas

170
PCS

HSS-G

DIN 338 N / ISO 235



ground / rectificadas / rectificadas

Helicoidal twist drill

cobalt-alloyed, ground, cylindrical, short, right hand cutting, split point from $\varnothing 3$ mm, efficient, high concentricity, good chip removal

Broca helicoidal

aleación de cobalto, rectificada, cilíndrica, corta, corte a la derecha, centrado automático a partir de $\varnothing 3$ mm, de buen rendimiento, de alta concentricidad, buena evacuación de las virutas

Broca helicoidal

liga de cobalto, rectificada, cilíndrica, curta, corte à direita, centragem automática a partir de $\varnothing 3$ mm, bom desempenho, alta concentricidade, boa remoção de aparas

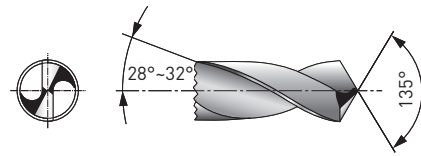

ground / rectificadas / rectificadas

HSS-E Co 5

DIN 338 N / ISO 235

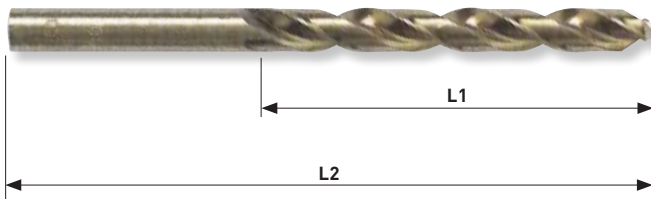

10
PCS

10 Pcs./pz./pz.

Art. 13010 - Art. 13080



5
PCS

5 Pcs./pz./pz.

Art. 13085 - Art. 13130



Art.	\varnothing mm	L1 mm	L2 mm
13010	1.0	12	34
13015	1.5	18	40
13020	2.0	24	49
13025	2.5	30	57
13030	3.0	33	61
13032	3.2	36	65
13033	3.3	36	65
13035	3.5	39	70
13040	4.0	43	75
13042	4.2	43	75
13045	4.5	47	80

Art.	\varnothing mm	L1 mm	L2 mm
13048	4.8	53	86
13050	5.0	52	86
13055	5.5	57	93
13060	6.0	57	93
13065	6.5	63	101
13068	6.8	69	109
13070	7.0	69	109
13075	7.5	69	109
13080	8.0	75	117
13085	8.5	75	117
13090	9.0	81	125

Art.	\varnothing mm	L1 mm	L2 mm
13095	9.5	81	125
13100	10.0	87	133
13102	10.2	87	133
13105	10.5	87	133
13110	11.0	94	142
13115	11.5	94	142
13120	12.0	101	151
13125	12.5	101	151
13130	13.0	101	151

Helicoidal twist drill set

cobalt-alloyed, ground, cylindrical, short, right hand cutting, split point from Ø 3 mm, efficient, high concentricity, good chip removal

Juego de brocas helicoidales

aleación de cobalto, rectificadas, cilíndricas, cortas, corte a la derecha, centrado automático a partir de Ø 3 mm, de buen rendimiento, de alta concentricidad, buena evacuación de las virutas

Jogo de brocas helicoidais

ligadas de cobalto, rectificadas, cilíndricas, curtas, corte à direita, centragem automática a partir de Ø 3 mm, bom desempenho, alta concentricidade, boa remoção de aparas

Art.	Ø mm
13904	1.0-1.5-2.0-2.5-3.0-3.5-4.0-4.5-5.0-5.5 6.0-6.5-7.0-7.5-8.0-8.5-9.0-9.5-10.0

Helicoidal twist drill set

cobalt-alloyed, ground, cylindrical, short, right hand cutting, split point from Ø 3 mm, efficient, high concentricity, good chip removal

Juego de brocas helicoidales

aleación de cobalto, rectificadas, cilíndricas, cortas, corte a la derecha, centrado automático a partir de Ø 3 mm, de buen rendimiento, de alta concentricidad, buena evacuación de las virutas

Jogo de brocas helicoidais

ligadas de cobalto, rectificadas, cilíndricas, curtas, corte à direita, centragem automática a partir de Ø 3 mm, bom desempenho, alta concentricidade, boa remoção de aparas

Art.	Ø mm
13905	1.0-1.5-2.0-2.5-3.0-3.5-4.0-4.5-5.0-5.5-6.0-6.5-7.0 7.5-8.0-8.5-9.0-9.5-10.0-10.5-11.0-11.5-12.0-12.5-13.0

Helicoidal twist drill case

cobalt-alloyed, ground, cylindrical, short, right hand cutting, split point from Ø 3 mm, efficient, high concentricity, good chip removal

Estuche de brocas helicoidales

aleación de cobalto, rectificadas, cilíndricas, cortas, corte a la derecha, centrado automático a partir de Ø 3 mm, de buen rendimiento, de alta concentricidad, buena evacuación de las virutas

Mala de brocas helicoidais

ligadas de cobalto, rectificadas, cilíndricas, curtas, corte à direita, centragem automática a partir de Ø 3 mm, bom desempenho, alta concentricidade, boa remoção de aparas

Art.	Pcs.	Ø mm
13910	10	1.0-1.5-2.0-2.5-3.0-3.5-4.0-4.5
	10	5.0-5.5-6.0-6.5-7.0-7.5-8.0
	5	8.5-9.0-9.5-10.0

19
PCS

HSS-E Co 5

DIN 338 N / ISO 235



ground / rectificadas / rectificadas

25
PCS

HSS-E Co 5

DIN 338 N / ISO 235



ground / rectificadas / rectificadas

170
PCS

HSS-E Co 5

DIN 338 N / ISO 235



ground / rectificadas / rectificadas

Helicoidal twist drill for core holes

ground, cylindrical, short, right hand cutting, split point from $\varnothing 3$ mm, efficient, high concentricity, good chip removal

Broca helicoidal trepanadora

rectificada, cilíndrica, corta, corte a la derecha, centrado automático a partir de $\varnothing 3$ mm, de buen rendimiento, de alta concentricidad, buena evacuación de las virutas

Broca helicoidal

rectificada, cilíndrica, curta, corte à direita, centragem automática a partir de $\varnothing 3$ mm, bom desempenho, alta concentricidade, boa remoção de aparas

Art.	\varnothing mm	L1 mm	L2 mm	PCS.
15016	1.6 (M2)	20	43	3
15020.5	2.05 (M2.5)	24	49	3
15025	2.5 (M3)	30	57	3
15033	3.3 (M4)	36	65	3
15042	4.2 (M5)	43	75	2
15050	5.0 (M6)	52	86	2
15068	6.8 (M8)	69	109	1
15085	8.5 (M10)	75	117	1
15102	10.2 (M12)	87	133	1

HSS-G

DIN 338 N / ISO 235

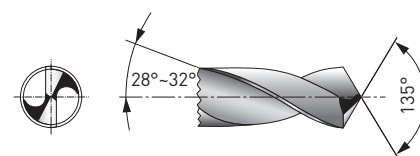
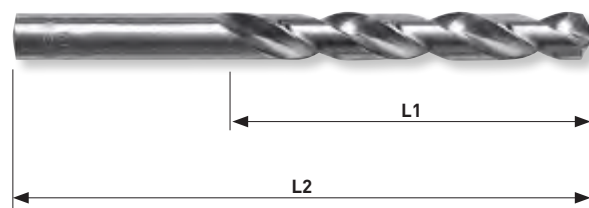

ground / rectificadas / rectificadas

Hand tap set

directly ground from the rod, set of 3 pieces with taper tap, second tap and plug tap, high cutting performance

Juego de machos manuales

rectificados de una pieza, juego de 3 piezas con desbaste, intermedio y acabado, alto rendimiento de corte

Jogo de machos

rectificados, jogo de 3 peças com desbaste, intermédio e acabamento, alto desempenho de corte

Art.	\varnothing mm	mm	L mm	PCS.
21030	M3 (2.5)	0.5	44	3
21040	M4 (3.3)	0.7	47	3
21050	M5 (4.2)	0.8	53	3
21060	M6 (5.0)	1	55	3
21080	M8 (6.8)	1.25	56	3
21100	M10 (8.5)	1.5	69	3
21120	M12 (10.2)	1.75	75	3

HSS-G

DIN 352 / ISO 2857

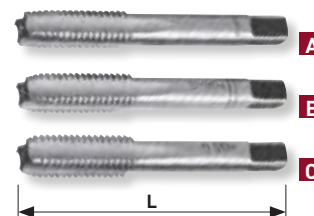

A Taper tap
Desbaste
Iniciar

B Second tap
Intermedio
Intermédio

C Plug tap
Acabado
Acabamento

Short machine and hand tap



directly ground from the rod, high cutting performance

Macho manual y a máquina

corto, rectificado de una pieza, alto rendimiento de corte

Macho manual e máquina

curto, rectificado, alto desempenho de corte

Art.	 Ø mm	 mm	L mm	PCS.
22020	M2 (1.6)	0.4	38	1
22025	M2.5 (2.05)	0.45	43	1
22030	M3 (2.5)	0.5	44	1
22040	M4 (3.3)	0.7	47	1
22050	M5 (4.2)	0.8	53	1
22060	M6 (5.0)	1	55	1
22080	M8 (6.8)	1.25	56	1
22100	M10 (8.5)	1.5	69	1
22120	M12 (10.2)	1.75	75	1

Short machine and hand tap



directly ground from the rod, high cutting performance

Macho manual y a máquina

corto, rectificado de una pieza, alto rendimiento de corte

Macho manual e máquina

curto, rectificado, alto desempenho de corte

Art.	 Ø mm	 mm	L1 mm	L2 mm	PCS.
4900-51T05	M5 (5.2)	0.8	21	61	1
4900-51T06	M6 (6.3)	1	24	69	1
4900-51T08	M8 (8.4)	1.25	28	78	1
4900-51T10	M10 (10.5)	1.5	33	89	1
4900-51T12	M12 (12.5)	1.75	32	88	1
4900-51T14	M14 (14.5)	2	40	100	1

HSS-G

DIN 352 / ISO 2857

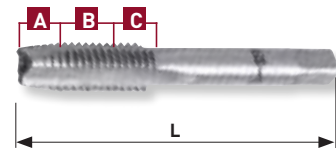

- A** Taper tap
Desbaste
Iniciar
- B** Second tap
Intermedio
Intermédio
- C** Plug tap
Acabado
Acabamento

HSS

DIN 371

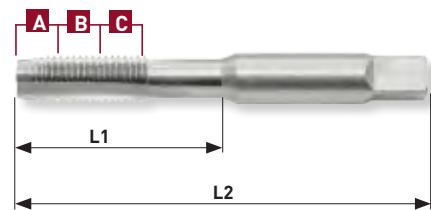

- A** Taper tap
Desbaste
Iniciar
- B** Second tap
Intermedio
Intermédio
- C** Plug tap
Acabado
Acabamento

Long machine tap



directly ground from the rod, high cutting performance

Macho a máquina

largo, rectificado de una pieza, alto rendimiento de corte

Macho de máquina

longo, rectificado, alto desempenho de corte

Art.	 \emptyset mm	 mm	L1 mm	L2 mm	PCS.
25030	M3 (2.5)	0.5	21	61	1
25040	M4 (3.3)	0.7	24	69	1
25050	M5 (4.2)	0.8	28	78	1
25060	M6 (5.0)	1	33	89	1
25080	M8 (6.8)	1.25	32	88	1
25100	M10 (8.5)	1.5	40	100	1
25120	M12 (10.2)	1.75	80	110	1

HSS-G

DIN 371

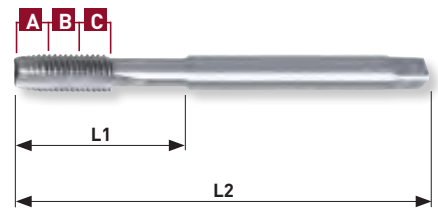

- A** Taper tap
Desbaste
Iniciar
- B** Second tap
Intermedio
Intermédio
- C** Plug tap
Acabado
Acabamento

Adjustable tap wrench

Giramacho ajustable

Porta-machos ajustável

Art.	No.	\emptyset	L mm
24015	1-1/2	M2 - M12	175

DIN 1814

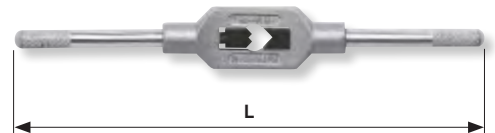

Adjustable tap wrench

Giramacho ajustable

Porta-machos ajustável

Art.	No.	\emptyset	L mm
4900-51A412	2	M4 - M12	280
4900-51A620	3	M6 - M20	375

DIN 1814



Tap holder with ratchet
Giramacho con carraca
Porta-machos com roquete

Art.	No.	Ø	L1 mm	L2 mm
24110	1	M3 - M10	100	86

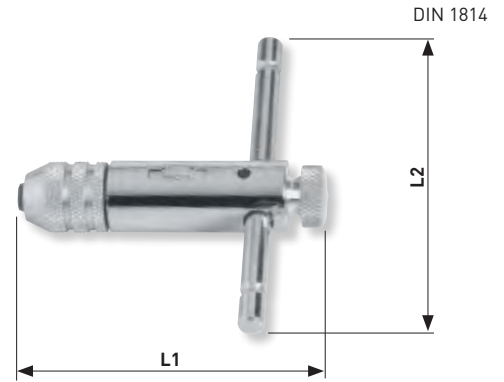

Die
round, high cutting performance

Terraja
redonda, alto rendimiento de corte

Caçoneto
redondo, alto desempenho de corte

Art.	Ø	mm	D mm
26030	M3	0.5	25
26040	M4	0.7	25
26050	M5	0.8	25
26060	M6	1	25
26080	M8	1.25	25
26100	M10	1.5	25
26120	M12	1.75	25

HSS-G

DIN / ISO 261



Die stock
Portaterras
Porta-caçonetos

Art.	No.	Ø	L mm
24010	3	M3 - M12	215

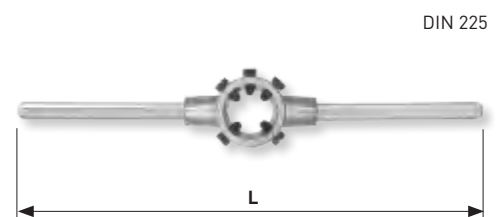

Die with holder

high cutting performance

Terraaja con portaterraaja

alto rendimiento de corte

Caçoneto com suporte

alto desempenho de corte

Art.	Ø	mm	D mm
23020	M2	0.4	179
23025	M2.5	0.45	179
23030	M3	0.5	179
23040	M4	0.7	179
23050	M5	0.8	179
23060	M6	1	221
23080	M8	1.25	221
23100	M10	1.5	221
23120	M12	1.75	221

HSS-G

ERGOKRAFT



Pitch gear

Galga para rosca

Conta fios

Art.	mm
24200	0.25-0.30-0.35-0.40-0.45-0.50-0.60-0.70 0.75-0.80-0.90-1.00-1.25-1.50-1.75-2.00 2.50-3.00-3.50-4.00-4.50-5.00-5.00-5.50-6.00

24
PCS



Pitch gear

Galga para rosca

Conta fios

Art.	mm
4900-51A1240	0.25-0.30-0.35-0.40-0.45-0.50-0.60-0.70 0.75-0.80-0.90-1.00-1.25-1.50-1.75-2.00

16
PCS



Drill, machine and hand tap + die set
ground



Juego de brocas, machos manuales, a máquina y terrajas
rectificadas





Jogo de brocas, machos manual, máquina e caçonetos
rectificados

24
PCS

HSS-G

Art.	Ø
3240MOD	M3 - M12

	Art. 26030 M3		Art. 11025 2.5 mm
	Art. 26040 M4		Art. 11033 3.3 mm
	Art. 26050 M5		Art. 11042 4.2 mm
	Art. 26060 M6		Art. 11050 5.0 mm
	Art. 26080 M8		Art. 11068 6.8 mm
	Art. 26100 M10		Art. 11085 8.5 mm
	Art. 26120 M12		Art. 11102 10.2 mm

	Art. 24010 No. 3 M3-M12		Art. 22030 M3
	Art. 24015 No. 1-1/2 M2-M12		Art. 22040 M4
			Art. 22050 M5
			Art. 22060 M6
			Art. 22080 M8
			Art. 22100 M10
			Art. 22120 M12



270 x 150 x 55 mm

Drill, and tap + die case
ground



Estuche de brocas, machos manuales y terrajas
rectificadas







Estojo de brocas, machos e caçonetos
rectificados

56
PCS

HSS-G

Art.	Ø
3245MOD	M3 - M12

	Art. 26030 M3		Art. 11033 3.3 mm
	Art. 26040 M4		Art. 11042 4.2 mm
	Art. 26050 M5		Art. 11068 6.8 mm
	Art. 26060 M6		Art. 11102 10.2 mm
	Art. 26080 M8		
	Art. 26100 M10		
	Art. 26120 M12		

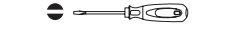
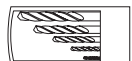
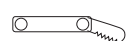
	Art. 24010 No. 3 M3-M12		Art. 21030 M3
	Art. 24015 No. 1-1/2 M2-M12		Art. 21040 M4
			Art. 21050 M5
	Art. 24110 No. 1 M3-M10		Art. 21060 M6
			Art. 21080 M8
			Art. 21100 M10
			Art. 21120 M12
			Art. 11904 1-10 / 0.5 mm
			Art. 24200 0.25-6.0 mm



410 x 275 x 70 mm

Drill, and tap + die case













ground

Estuche de brocas, machos manuales y terrajas

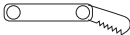
rectificadas

Estojo de brocas, machos e caçonetos

rectificados

Art.	Ø
4900-59K	M3 - M12
	Art. 26030 M3
	Art. 26040 M4
	Art. 26050 M5
	Art. 26060 M6
	Art. 26080 M8
	Art. 26100 M10
	Art. 26120 M12
	Art. 24200 0.25-6.0 mm / 60°
	Art. 24010 M3-M12
	Art. 24015 M2-M12
	Art. 24110 M3-M10
	Art. 3240S  0.5 mm











42
PCS

HSS-G

COMPLETO



402 x 173 x 48 mm

	Art. 11033 3.3 mm
	Art. 11042 4.2 mm
	Art. 11068 6.8 mm
	Art. 11102 10.2 mm
	Art. 25030 M3
	Art. 25040 M4
	Art. 25050 M5
	Art. 25060 M6
	Art. 25080 M8
	Art. 25100 M10
	Art. 25120 M12

Art. 11904 1-10 / 0.5 mm

Drill, machine and hand tap + die set

ground, with dies with holder









Juego de brocas, machos manuales

y a máquina y terrajas

rectificadas, con terrajas con portaterraja

Jogo de brocas, machos manual, máquina e caçonetos,

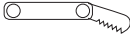
rectificados, com caçonetos com suporte

Art.	Ø
4900-34K	M3 - M12
	Art. 23030 M3
	Art. 23040 M4
	Art. 23050 M5
	Art. 23060 M6
	Art. 23080 M8
	Art. 23100 M10
	Art. 23120 M12
	Art. 24200 0.25-6.0 mm
	Art. 24015 No. 1-1/2 M2-M12
	Art. 24110 No. 1 M3-M10











40
PCS

HSS-G

COMPLETO



421 x 200 x 68 mm

	Art. 11033 3.3 mm
	Art. 11042 4.2 mm
	Art. 11068 6.8 mm
	Art. 11102 10.2 mm
	Art. 25030 M3
	Art. 25040 M4
	Art. 25050 M5
	Art. 25060 M6
	Art. 25080 M8
	Art. 25100 M10
	Art. 25120 M12

Art. 11904 1-10 / 0.5 mm

Thread inserts

Helicoides

Roscas falsas

Art.	Ø	Pcs.
28050	M5 x 0.8	12
28060	M6 x 1.0	12
28080	M8 x 1.25	12
28100	M10 x 1.25	12
28120	M12 x 1.75	6
28140	M14 x 1.25	6



Tang puncher

Centrador

Punção

Art.	Ø
4900-51P05	M5
4900-51P06	M6
4900-51P08	M8
4900-51P10	M10
4900-51P12	M12
4900-51P14	M14



Coil installation shank

Insertos helicoil

Ferramenta de instalação

Art.	Ø
4900-51S05	M5
4900-51S06	M6
4900-51S08	M8
4900-51S10	M10
4900-51S12	M12
4900-51S14	M14



Telescope magnetic pick up
Dedo magnético telescópico
Pesca peças telescópico magnético

Art.
4900-51M



Rachtet driver for thread inserts
Maneral de instalación de helicoides
Roquete de instalação de roscas falsas

Art.
4900-51R



Threaded coil-insert repair kit
with coils
Caja de herramientas para reparar roscas
con helicoides
Kit de ferramentas para reparação de roscas
com roscas

Art.
4900-51K

77
PCS

COMPLETO



M4-M12, M6-M20
3/18"-1/2", 1/4"-3/4"



M5x0.8, M6x1.0,
M8x1.25, M10x1.5,
M12x1.75, M14x1.25



M5x0.8, M6x1.0,
M8x1.25, M10x1.5,
M12x1.75, M14x1.25



HSS-G

M5x0.8, M6x1.0,
M8x1.25, M10x1.5,
M12x1.75, M14x1.25



215-640 mm

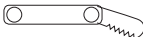

0.5-1.75 mm



16 M5-0.8
12 M6-1.0
10 M8-1.25
6 M10-1.5
5 M12-1.75
4 M14-1.25

Step drill with spiral flute

with ground spiral groove and edge breaker, very high cutting performance

Broca escalonada

con ranura rectificada helicoidal y espigador, muy alto rendimiento de corte

Fresa cónica escalonada

rectificada, com ranhura em espiral e espigão, alto rendimento de corte

Art.	min-max Ø mm	t1 mm	t2 mm	D1 mm	L1 mm	L2 mm
18010	4-5-6-7-8-9-10-11-12	7	4.5	6	20	65
18020	4-6-8-10 12-14-16-18-20	8	5.5	8	20	75
18030	4-6-8-10-12-14-16 18-20-22-24-26-28-30	8	5	10	22	100

Step drill set with spiral flute

with ground spiral groove and edge breaker, very high cutting performance

Juego de brocas escalonadas

con ranura rectificada helicoidal y espigador, muy alto rendimiento de corte

Jogo de fresas cónicas escalonadas

rectificadas, com ranhura em espiral e espigão, alto rendimento de corte

Art. 18010 4-12 mm
Art. 18020 4-20 mm
Art. 18030 4-30 mm

Art.	min-max Ø mm
18000	4 - 12 / 4 - 20 / 4 - 30

Tube and sheet drill

with ground groove, conique form at 20°, very high cutting performance

Broca cónica

con ranura rectificada, forma cónica de 20°, muy alto rendimiento de corte

Fresa cónica

rectificada com ranhura, forma cônica à 20°, alto desempenho de corte

Art.	min-max Ø mm		D1 mm	L1 mm	L2 mm
18110	3 - 14	10°	6	20	58
18120	5 - 20	10°	8	20	71
18130	16 - 30.5	12°	9	22	77

HSS-E Co 5%

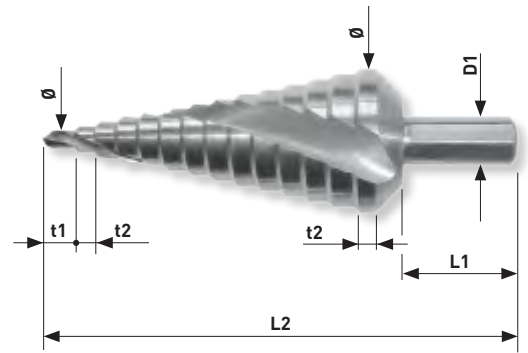

3
PCS

HSS-E Co 5%



HSS-E Co 5%

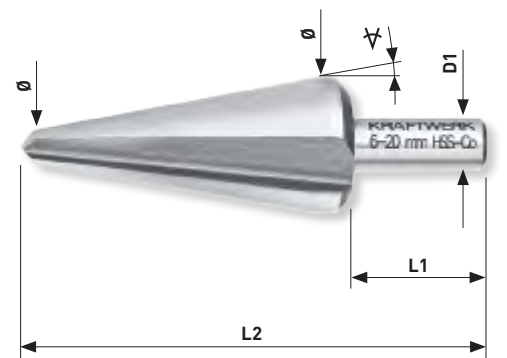

Tube and sheet drill set

with ground groove, conique form at 20°, very high cutting performance

Juego de brocas cónicas

con ranura rectificada, forma cónica de 20°, muy alto rendimiento de corte

Jogo de fresas cónicas

rectificadas com ranhura, forma cônica à 20°, desempenho alto de corte

Art. 18110 3-14 mm
Art. 18120 5-20 mm
Art. 18130 16-30.5 mm

Art.	min-max Ø mm
18100	3 - 14 / 5 - 20 / 16 - 30.5

Countersink

90°, 3 ground flutes

Avellanador

90°, de tres filos rectificados

Fresa de escarear

90°, 3 lâminas rectificadas

Art.	Ø mm	D1 mm	D2 mm	L mm
18210	6.3	1.5	5	45
18220	8.3	2	6	50
18230	10.4	2.5	6	50
18240	12.4	2.8	8	56
18250	16.5	3.2	10	60
18260	20.5	3.5	10	63

Countersink set

90°, 3 ground flutes

Juego de avellanadores

90°, de tres filos rectificados

Jogo de fresas de escarear

90°, 3 lâminas rectificadas

Art. 18210 6.3 mm
Art. 18220 8.3 mm
Art. 18230 10.4 mm
Art. 18240 12.4 mm
Art. 18250 16.5 mm
Art. 18260 20.5 mm

Art.	Ø mm
18200	6.3 - 8.3 - 10.4 - 12.4 - 16.5 - 20.5

3
PCS

HSS-E Co 5%



HSS-E Co 5%

DIN 335 C

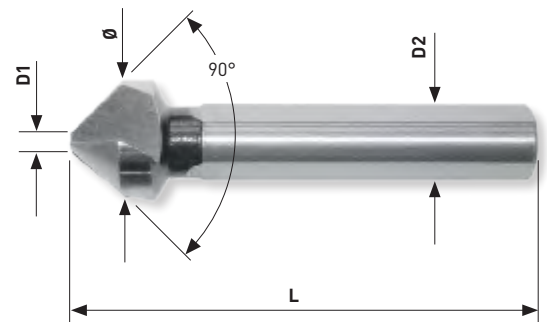

6
PCS

HSS-E Co 5%

DIN 335 C



Flat countersink

Avellanador para asientos de tornillos

Fresa direita

Art.	∅ mm	D1 mm	D2 mm	L mm
18310	3.4 (M3)	6	5	71
18320	4.5 (M4)	8	5	71
18330	5.5 (M5)	10	8	80
18340	6.6 (M6)	11	8	80
18350	9 (M8)	15	12.5	100
18360	11 (M10)	18	12.5	100

Flat countersink set

Juego de avellanadores para asientos de tornillos

Jogo de fresas direitas

Art. 18310 3.4 mm / M3
Art. 18320 4.5 mm / M4
Art. 18330 5.5 mm / M5
Art. 18340 6.6 mm / M6
Art. 18350 9.0 mm / M8
Art. 18360 11.0 mm / M10

Art.	∅ mm
18300	3.4-4.5-5.5-6.6-9.0-11.0

Hole saw

Corona perforada

Broca craniana

Art.	∅ mm		L mm
19190	19	Art. 19001	50
19200	20	Art. 19001	48
19220	22	Art. 19001	48
19250	25	Art. 19001	48
19290	29	Art. 19001	48
19320	32	Art. 19002	50
19350	35	Art. 19002	48
19380	38	Art. 19002	44
19440	44	Art. 19002	43
19510	51	Art. 19002	43
19570	57	Art. 19002	43
19650	65	Art. 19002	43
19680	68	Art. 19002	43
19760	76	Art. 19002	43

HSS-E Co 5%

DIN 373

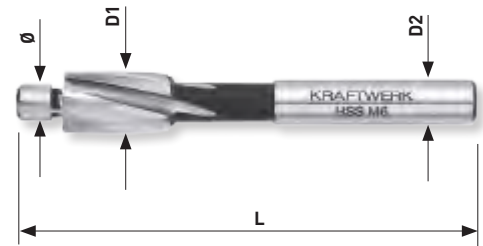

6
PCS

HSS-E Co 5%

DIN 335 C



HSS-E Co 8% Bi-Metall

DIN 335 C

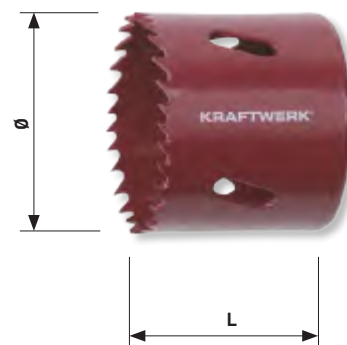

Hole saw arbor with pilot drill

Husillo con broca guía

Suporte para brocas com broca guia

Art.	∅	inch	L1 mm	L2 mm	∅ mm
19001	M14	3/8"	50	95	14 - 30

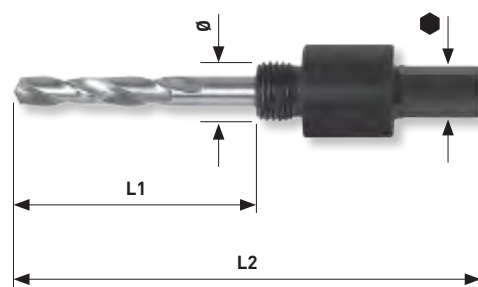

Hole saw arbor SDS-plus with pilot drill

Husillo SDS-plus con broca guía

Suporte SDS-plus para brocas com broca guia

Art.	∅	SDS-plus	L1 mm	L2 mm	∅ mm
19005	M14	SDS-Plus	46	126	14 - 30

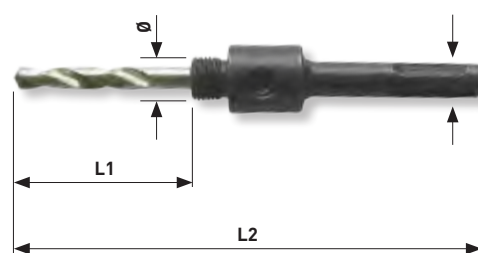

Hole saw arbor with pilot drill

Husillo con broca guía

Suporte para brocas com broca guia

Art.	∅	inch	L1 mm	L2 mm	∅ mm
19002	M14	7/16"	50	118	32 - 76

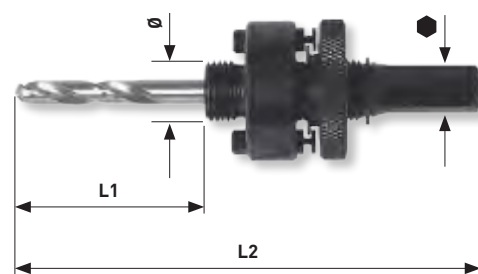

Hole saw arbor SDS-plus with pilot drill

Husillo SDS-plus con broca guía

Suporte SDS-plus para brocas com broca guia

Art.	∅	SDS-plus	L1 mm	L2 mm	∅ mm
19006	M14	SDS-Plus	46	146	32 - 76

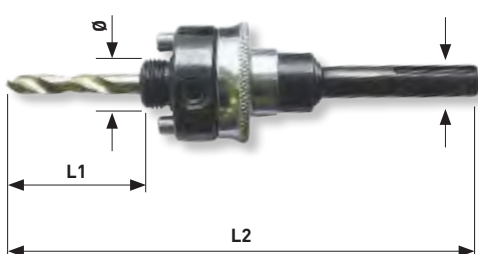

Pilot drill

Broca guía

Broca guia

Art.	∅ inch / mm	L mm
19004	1/4" / 6,35 mm	75

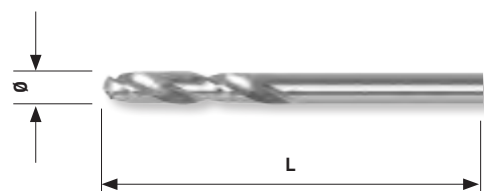

Extension bar for hole saws

Alargadera para coronas perforadas

Extensão para brocas cranianas

Art.	inch	mm	L mm
19003	3/8"	3/8"	300

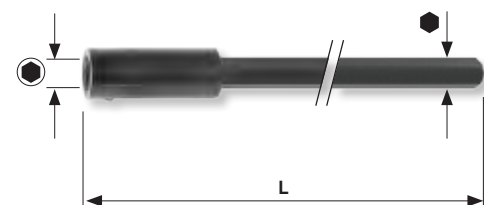

Hole saw case
Estuche de coronas perforadas
Mala de brocas cranianas

HSS
bimetal
M42+8%Co

COMPLETO



HSS-E Co 8% Bi-Metall M42

Art.		
4900-39K		✓
4900-39KS		

16
PCS

15
PCS



Art. 4900-39K

	Art. 19001	Art. 19005	14-30 mm / 3/8"
	Art. 19002	Art. 19006	32-76 mm / 7/16"
	Art. 19003		300 mm / 3/8"



Art. 4900-39B



Art. 19190	19 mm
Art. 19200	20 mm
Art. 19220	22 mm
Art. 19250	25 mm
Art. 19290	29 mm
Art. 19320	32 mm
Art. 19350	35 mm
Art. 19380	38 mm
Art. 19440	44 mm
Art. 19510	51 mm
Art. 19570	57 mm
Art. 19680	68 mm
Art. 19760	76 mm

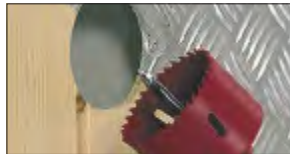

↕ 402 × 173 × 48 mm

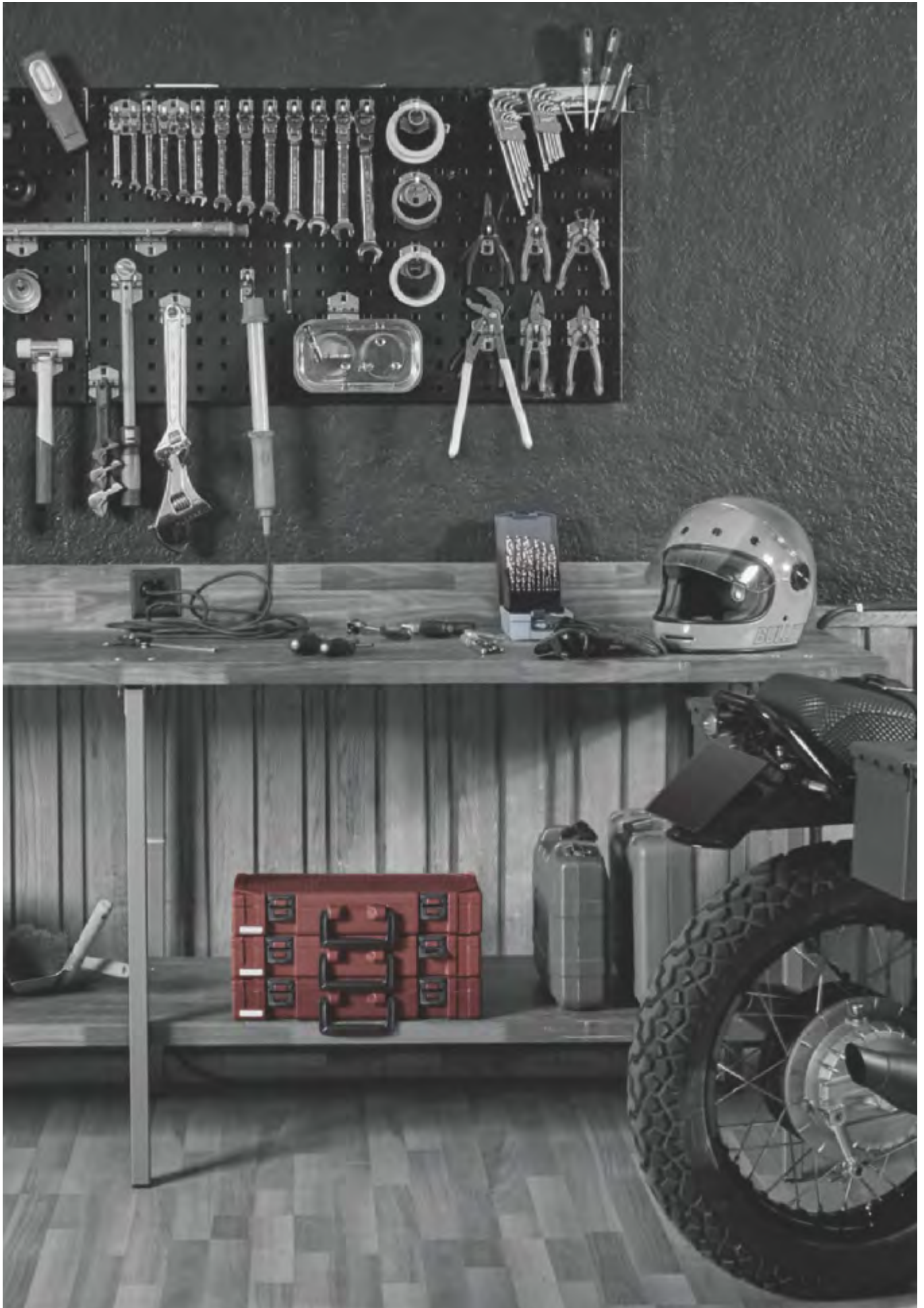

INDEX / INDICE / INDICE

Art. No.	Cat.	Art. No.	Cat.	Art. No.	Cat.	Art. No.	Cat.
1350-2	394	2053	123	2301	388	2586	255
1350-3	394	2056	122	2302	388	2589-01	253
1350-4	394	2057	123	2303	388	2589-02	253
1350-5	394	2138	273	2304	388	2589-0607	252
1350-6	394	2139	273	2305	388	2589-0809	252
1350-8	394	2187	271	2308	388	2589-1011	252
1927	16	2211	357	2310	388	2589-1213	252
2000	160	2212	356	2315	388	2589-1415	252
2000E	160	2212-A2	354	2319	389	2589-1617	252
2003	108	2213-A21	355	2320	393	2589-1819	252
2004	111	2214-J2	355	2323	393	2589-2022	252
2010	160	2215-J21	356	2336	392	2589-2123	252
2010E	160	2216-180	348	2336NY	392	2589-2427	252
2013	113	2216-200	348	2336PU	392	2589-2528	252
2020	160	2217-250	349	2339	391	2589-3032	252
2020E	160	2217-280	349	2340	391	2589-5810	253
2023	115	2223	360	2342	391	2590-0809	250
2025	116	2223-01	360	2345	391	2590-1011	250
2026	116	2223-2.4	360	2351	391	2590-1213	250
2032	120	2223-3.2	360	2352	391	2590-1415	250
2033	118	2223-4.0	360	2354	390	2590-1617	250
2034	119	2223-4.8	360	2355	390	2590-1819	250
2035	319	2224	360	2366	391	2590-3814	251
2035A12	306	2225	366	2368	392	2591-16	251
2035B38	305	2230	376	2376	390	2591-21	251
2035F06	304	2231	346	2378	390	2592-08	252
2035F08	304	2232	346	2380	390	2592-09	252
2035F10	304	2233	347	2381	390	2592-10	252
2035F12	304	2234	344	2383	390	2592-11	252
2035PH1	305	2235	345	2385	388	2592-12	252
2035PH2	305	2236	344	2387	388	2592-13	252
2035PH3	305	2237	345	2390	389	2592-14	252
2035PH4	305	2238	347	2392	389	2592-15	252
2035S	319	2240	380	2395	389	2592-16	252
2035T30	305	2241	381	2404	243	2592-17	252
2035T40	305	2242	381	2406	243	2592-18	252
2035T45	305	2243	382	2408	243	2592-19	252
2035T50	305	2244	382	2410	243	2593-02	287
2036	320	2245	382	2412	243	2593-03	287
2037	173	2246	382	2415	243	2593-04	287
2038.1	173	2251	381	2418	243	2593-05	287
2038.2	173	2252-225	358	2585-12	251	2593-06	287
2039	309	2253-200	358	2585-34	251	2593-07	287
2045	170	2254-275	359	2585-1719	251	2593-08	287
2045E	170	2262-07	365	2585-1721	251	2593-10	287

Art. No.	Cat.	Art. No.	Cat.	Art. No.	Cat.	Art. No.	Cat.
2593-025	287	2598-14	249	2673-5	294	2726-5	291
2594-10	289	2598-15	249	2674-5	294	2730-5	292
2594-15	289	2598-16	249	2676-5	293	2731-5	292
2594-20	289	2598-17	249	2677-5	293	2731-10	292
2594-25	289	2598-18	249	2678-5	293	2732-5	292
2594-27	289	2598-19	249	2679-5	293	2732-10	292
2594-30	289	2598-20	249	2680-5	293	2732-50	292
2594-40	289	2598-21	249	2681-5	293	2733-5	292
2594-45	289	2598-22	249	2683-5	293	2733-10	292
2594-50	289	2598-23	249	2684-5	293	2733-50	292
2597-06	248	2598-24	249	2685-5	293	2734-5	292
2597-07	248	2598-25	249	2686-5	293	2734-10	292
2597-08	248	2598-26	249	2687-5	293	2734-50	292
2597-09	248	2598-27	249	2688-5	293	2735-5	292
2597-10	248	2598-28	249	2689-5	294	2735-10	292
2597-11	248	2598-29	249	2690-5	299	2735-50	292
2597-12	248	2598-30	249	2694	306	2736-5	292
2597-13	248	2598-32	249	2696-5	294	2736-10	292
2597-14	248	2598-34	249	2697-5	299	2736-50	292
2597-15	248	2598-99	250	2700	309	2737-5	292
2597-16	248	2599-01	254	2701-5	291	2737-10	292
2597-17	248	2599-02	255	2701-10	291	2738-5	292
2597-18	248	2599-0607	254	2701-50	291	2739-5	292
2597-19	248	2599-0809	254	2702-5	291	2741-5	293
2597-20	248	2599-1011	254	2702-10	291	2741-10	293
2597-21	248	2599-1012	253	2702-50	291	2742-5	293
2597-22	248	2599-1213	254	2703-5	291	2742-10	293
2597-23	248	2599-1415	254	2703-10	291	2743-5	293
2597-24	248	2599-1617	254	2704-5	291	2743-10	293
2597-25	248	2599-1819	254	2705-5	291	2744-5	293
2597-26	248	2599-2022	254	2711-5	291	2744-10	293
2597-27	248	2599-2123	254	2711-10	291	2745-5	293
2597-28	248	2599-2427	254	2711-50	291	2746-5	293
2597-29	248	2599-2528	254	2712-5	291	2749-5	292
2597-30	248	2599-3032	254	2712-10	291	2750	306
2597-32	248	2599-3457	253	2712-50	291	2750-1	306
2597-99	250	2661-5	294	2713-5	291	2751-5	292
2598-06	249	2662-5	294	2713-10	291	2752-5	292
2598-07	249	2663-5	294	2713-50	291	2753-5	292
2598-08	249	2665-5	294	2714-5	291	2754-5	292
2598-09	249	2667-5	294	2721-5	291	2755-5	292
2598-10	249	2668-5	294	2722-5	291	2756-5	292
2598-11	249	2669-5	294	2723-5	291	2757-5	292
2598-12	249	2671-5	294	2724-5	291	2758	310
2598-13	249	2672-5	294	2725-5	291	2760	184, 305

INDEX / INDICE / INDICE

Art. No.	Cat.	Art. No.	Cat.	Art. No.	Cat.	Art. No.	Cat.
2761	192, 306	2844-5	298	2995	143	3090	158
2764	306	2845-5	298	2998	143	3091	158
2765	307	2846-5	298	3005	107	3092	158
2765-1	307	2850-5	299	3006	161	3093	158
2768	308	2860-5	299	3035	114	3094	158
2770-5	294	2861	298	3036	142	3094B	158
2778	317	2862	298	3057	322	3095	158
2780	310	2863	298	3057-02	321	3095B	158
2783	311	2864	298	3057-03	321	3096	158
2786	311	2865	298	3057-04	321	3096B	158
2790	311	2866	298	3057-05	321	3097	159
2801-5	297	2867	298	3057-06	321	3098	159
2801-10	297	2904	12	3057-07	321	3099	159
2802-5	297	2904-4909	34	3057-08	321	3132-1	272
2802-10	297	2904-4911	35	3057-10	321	3132-2	272
2802-25	297	2904-4931	73	3057-12	321	3132-3	272
2803-5	297	2905	11	3057-14	321	3132-4	272
2804-5	297	2905-4909	34	3057-16	321	3133-15	272
2811-5	297	2905-4911	35	3058	323	3133-20	272
2811-10	297	2905-4931	73	3058-10	323	3135-0	272
2812-5	297	2907	12	3058-11	323	3135-1	272
2812-10	297	2907-4909	34	3058-12	323	3135-2	272
2812-25	297	2907-4911	35	3058-13	323	3137-0	272
2813-5	297	2907-4917	91	3058-14	323	3137-1	272
2814-5	297	2907-4931	73	3058-15	323	3137-2	272
2821-5	297	2939	407	3058-16	323	3157	273
2822-5	297	2950	16	3058-17	323	3177	277
2823-5	297	2951	16	3058-19	323	3177-00	276
2824-5	297	2961	397	3059	321	3177-0	276
2825-5	297	2961E	397	3059-1	321	3177-1	276
2826-5	297	2962	397	3059-2	321	3177-15	276
2831-5	298	2962E	397	3059-3	321	3177-20	276
2832-5	298	2963	397	3059-4	321	3177-24	276
2832-10	298	2963E	397	3059-5	321	3177-30	276
2833-5	298	2964	397	3059-6	321	3177-35	276
2833-10	298	2964E	397	3060	322	3177-40	276
2834-5	298	2970	405	3060-06	322	3178	277
2834-10	298	2972	405	3060-08	322	3178-0	276
2835-5	298	2974	407	3060-10	322	3178-1	276
2835-10	298	2975	406	3060-12	322	3178-05	276
2836-5	298	2976	404	3083	126	3178-06	276
2837-5	298	2977	406	3084	127	3178-07	276
2841-5	298	2978	404	3086	127	3178-08	276
2842-5	298	2980	406	3087	128	3178-09	277
2843-5	298	2990B	131	3089	128	3178-10	277

Art. No.	Cat.	Art. No.	Cat.	Art. No.	Cat.	Art. No.	Cat.
3178-15	277	3235-G27	168	3282-160V	341	3331-032	398
3178-20	277	3235-G30	168	3283-180	333	3331-050	398
3180	278	3235GK1	168	3284-160	334	3331-063	398
3181	278	3235GK2	168	3285-160	336	3331-075	398
3182	278	3235H	167	3285-200	336	3331-100	398
3188	325	3235K1	166	3285-200V	342	3331-125	398
3190	326	3235K2	166	3286-200	336	3332-032	399
3195	326	3235K3	167	3287-160	337	3332-075	399
3196	326	3235-R13	169	3288-160	338	3333-032	399
3197	325	3235-R14	169	3289-160	339	3333-075	399
3198	326	3235-R15	169	3289-160V	343	3335	398
3200	160	3235-R17	169	3290-175	351	3336	399
3200E	160	3235-R19	169	3290-230	367	3338	380
3201B	161	3235-R22	169	3290-250	351	3338E	380
3201F	161	3235-R24	169	3290-300	351	3341	409
3204	160	3235-R27	169	3291	368	3342	409
3206	162	3235-R30	169	3291-220	368	3350	394
3206E	162	3235RK1	169	3292	339	3350-2	393
3208	163	3235RK2	169	3292-150	358	3350-3	393
3210	160	3235-U12P	170	3292-175	358	3350-4	393
3210E	160	3235-U12R	170	3292-250	358	3350-5	393
3214	160	3236	165	3301	372	3350-6	393
3216	162	3236GK1	168	3302	372	3350-8	393
3216E	162	3236GK2	168	3303	372	3355	395
3218	163	3236H	167	3303H	373	3355-2	394
3220	160	3236K1	166	3304	372	3355-3	394
3220E	160	3236K2	166	3305	383	3355-4	394
3226	162	3236K3	167	3308-1	383	3355-5	394
3226E	162	3236RK1	169	3309	383	3355-6	394
3228	163	3236RK2	169	3310	373	3358-1	395
3231	165	3237	165	3311	373	3358-2	395
3232	165	3237E	166	3312	374	3359	397
3232E	166	3240MOD	424	3313	374	3359E	397
3233	165	3245MOD	424	3314	375	3365-12	395
3233-34E	166	3254	367	3315	374	3365-18	395
3234	165	3266-180	351	3316-18	383	3368-5	396
3235	165	3266-250	351	3316-24	383	3368-7	396
3235-36E	166	3266-300	351	3316-32	383	3370	396
3235-G13	168	3266SET	351	3317	373	3374	396
3235-G14	168	3281-160	331	3318	374	3380-18	395
3235-G15	168	3281-180	331	3319	383	3380-22	395
3235-G17	168	3281-180V	340	3322	375	3400-50	224
3235-G19	168	3281-200	331	3323	375	3400-54	224
3235-G22	168	3282-140	332	3324	376	3401-08	221
3235-G24	168	3282-160	332	3325	376	3401-09	221

INDEX / *INDICE* / INDICE

Art. No.	Cat.	Art. No.	Cat.	Art. No.	Cat.	Art. No.	Cat.
3401-10	221	3403-19	233	3418	223	3489	245
3401-11	221	3403-20	233	3419	223	3491	245
3401-12	221	3403-21	233	3420	223	3492	245
3401-13	221	3403-22	233	3421	223	3493	245
3401-14	221	3403-24	233	3422	223	3494	245
3401-15	221	3403-51	234	3424	223	3497	245
3401-16	221	3403-54	234	3427	224	3497R	245
3401-17	221	3404-4x2	233	3427M	223	3498	246
3401-18	221	3404-08	230	3430	225	3498R	246
3401-19	221	3404-09	230	3430M	223	3503-56	240
3401-20	221	3404-10	230	3431	225	3505	237
3401-21	221	3404-11	230	3432	225	3506	237
3401-22	221	3404-12	230	3432M	223	3507	237
3401-24	221	3404-13	230	3433	225	3508	237
3401-50	221	3404-14	230	3434	225	3509	237
3401-54	222	3404-15	230	3434M	223	3510	237
3402-08	235	3404-16	230	3435	225	3511	237
3402-09	235	3404-17	230	3436	225	3512	237
3402-10	235	3404-18	230	3436M	223	3513	237
3402-11	235	3404-19	230	3437	225	3514	237
3402-12	235	3404-20	230	3438	225	3515	237
3402-13	235	3404-21	230	3440	229	3516	237
3402-14	235	3404-22	230	3441	229	3517	237
3402-15	235	3404-24	230	3441M	223	3518	237
3402-16	235	3404-50	231	3442	229	3519	237
3402-17	235	3404-51	231	3443	229	3520	237
3402-18	235	3404-54	231	3444	229	3521	237
3402-19	235	3404-0813	232	3445	229	3522	237
3403-08	233	3404-1019	232	3446	229	3523	237
3403-08S	235	3404-1619	232	3446M	223	3524	237
3403-09	233	3404-51612	232	3447	229	3525	237
3403-10	233	3404-91634	232	3450M	223	3526	237
3403-10S	235	3405	223	3471	229	3527	237
3403-11	233	3406	223	3472	229	3528	237
3403-11S	235	3407	223	3473	229	3530	237
3403-12	233	3408	223	3474	229	3532	237
3403-12S	235	3409	223	3480	245	3534	237
3403-13	233	3410	223	3481	245	3536	237
3403-13S	235	3411	223	3482	245	3538	237
3403-14	233	3412	223	3483	245	3541	237
3403-14S	235	3413	223	3484	245	3545	247
3403-15	233	3414	223	3485	245	3546	246
3403-16	233	3415	223	3486	245	3546M	237
3403-17	233	3416	223	3487	245	3547	246
3403-18	233	3417	223	3488	245	3548	246

Art. No.	Cat.	Art. No.	Cat.	Art. No.	Cat.	Art. No.	Cat.
3549	246	3589	240	3604-2.5	281	3609-15	286
3550	238	3590	240	3604-3	281	3609-20	286
3550M	237	3591	240	3604-4	281	3609-25	286
3551	242	3592	240	3604-5	281	3609-27	286
3552	242	3593	240	3604-6	281	3609-30	286
3553	239	3594	240	3604-7	281	3609-40	286
3553R	239	3595	240	3604-8	281	3609-45	286
3554	239	3596	240	3604-10	281	3609-50	286
3554R	239	3597	240	3605	283	3609S	286
3556	238	3598	240	3605-10	283	3623	290
3557	238	3599	240	3605-15	283	3624	290
3557R	238	3601	279	3605-20	283	3625	288
3558	239	3601-1.5	279	3605-25	283	3626	288
3558R	239	3601-2	279	3605-27	283	3627	288
3560	242	3601-2.5	279	3605-30	283	3634	274
3561	242	3601-3	279	3605-40	283	3636-2	274
3562	242	3601-4	279	3605-45	283	3636-2.5	274
3563	242	3601-5	279	3605-50	283	3636-3	274
3564	242	3601-6	279	3606	282	3636-4	274
3565	242	3601-8	279	3606-12	281	3636-5	274
3566	242	3601-10	279	3606-14	281	3636-6	274
3567	242	3602	280	3606-17	281	3636-7	274
3568	242	3602-1.5	280	3606-19	281	3636-8	274
3569	242	3602-2	280	3607	284	3636-10	274
3570	242	3602-2.5	280	3607-10	284	3636-12	274
3570R	242	3602-3	280	3607-15	284	3637-10	275
3577	244	3602-4	280	3607-20	284	3637-15	275
3579	242	3602-5	280	3607-25	284	3637-20	275
3580	247	3602-6	280	3607-27	284	3637-25	275
3580-00	247	3602-7	280	3607-30	284	3637-27	275
3580-01	247	3602-8	280	3607-40	284	3637-30	275
3580-02	247	3602-10	280	3607-45	284	3637-40	275
3580-03	247	3603	283	3607-50	284	3637-45	275
3580-04	247	3603-1/4	282	3608	285	3637-50	275
3580-05	247	3603-1/8	282	3608-10	285	3637-55	275
3580-06	247	3603-1/16	282	3608-15	285	3641	279
3582	244	3603-3/8	282	3608-20	285	3642	281
3583	242	3603-3/16	282	3608-25	285	3645	287
3584-U14	255	3603-3/32	282	3608-27	285	3691	236
3584-U38	255	3603-5/16	282	3608-30	285	3692	236
3585	241	3603-5/32	282	3608-40	285	3693	236
3585R	241	3603-5/64	282	3608-45	285	3750	307
3586	242	3604	282	3608-50	285	3760	307
3587	240	3604-1.5	281	3609	286	3764	307
3588	240	3604-2	281	3609-10	286	3764-1	307

INDEX / INDICE / INDICE

Art. No.	Cat.	Art. No.	Cat.	Art. No.	Cat.	Art. No.	Cat.
3766	308	3919	13	3958-30	147	3995.1	132
3767	308	3920	13	3959	146	3996ET	131
3768	308	3921	14	3959-30	147	4000	161
3769	308	3922	14	3962	33	4001	162
3776	313	3923	14, 31	3964-01	27	4001E	162
3777	315	3924	14	3964-02	24	4002	124
3782-1	312	3925	15, 31	3964-02-07	24	4003	110
3784-07	299	3927	15	3964-03	25	4004	109
3784-08	299	3929	17, 32	3964-04	25	4004R1	164
3784-10	299	3930	17	3964-05	25	4004R2	164
3784-13	299	3934	10	3964-06	28	4004RS	163
3784-M6	299	3934-99	10	3964-07	28	4007	106
3784-M8	299	3934-4909	34	3964-08	29	4009	160
3784-M10	299	3934-4911	35	3964-09	29	4009E	160
3784-M12	299	3934-4917	91	3964-10	28	4010	161
3786	314	3934-4931	73	3964-11	26	4011	162
3787	315	3935	11	3964-12	24	4011E	162
3788	313	3935-99	11	3964-12-01	24	4012	125
3789	313	3936	9	3964-13	26	4013	113
3792	319	3936-4920	38	3964-14	25	4015	140
3794	316	3936-4920F	38	3964-15	26	4015.1	140
3795	316	3936ES	15	3964-16	26	4017	112
3796	314	3944	135	3964-16-99	29	4019	160
3799	309	3944.1	135	3964-17	27	4019E	160
3905	9	3944.2	135	3964-18	29	4020	161
3905-4909	34	3946	136	3964-19	27	4021	162
3905-4911	35	3946.1	136	3964-20	30	4021E	162
3905-4931	73	3946.2	136	3964-21	30	4022	125
3907-1	8	3948	137	3964-22	30	4027	115
3907-4909	34	3948.1	137	3964-23	30	4029	160
3907-4911	35	3948.2	137	3964-24	28	4029E	160
3907-4917	91	3949	138	3964-25	27	4033	107
3907-4931	73	3949.1	138	3964A	19	4037	117
3908	8	3949.2	138	3964AIX	19	4045	114
3908-4909	34	3950	144	3964B	20	4047	130
3908-4911	35	3952	144	3964BIX	20	4055	134
3908-4917	91	3953	144	3964D	21	4070	310
3908-4931	73	3954	144	3964DIX	21	4072	318
3912	102	3955	145	3964E	22	4081-12	172
3912-99	103	3955-30	147	3964EIX	22	4081-14	172
3912A	102	3956	145	3964F	23	4081-34	172
3917	10	3956-30	147	3964FIX	23	4081-38	172
3917-4919	98	3957	145	3966	408	4081-341	172
3917-4919+3	98	3957-30	147	3970	407	4110-1	259
3918	13	3958	146	3995	132	4110-2	259

Art. No.	Cat.	Art. No.	Cat.	Art. No.	Cat.	Art. No.	Cat.
4110-3	259	4140-5	259	4234-115	346	4261-2	361
4110-4	259	4140-6	259	4235-115	344	4261-3	361
4110-5	259	4145-1	260	4241-230	349	4261-4	361
4110-6	259	4145-2	260	4241-260	349	4261-5	361
4112-2	259	4149	320	4241-300	349	4262	362
4115-0	260	4150-1	261	4242-180	348	4262-1	362
4115-1	260	4150-2	261	4242-210	348	4262-2	362
4115-2	260	4160	263	4242-250	348	4262-3	362
4115-3	260	4161	263	4248-220	359	4262-4	362
4117-2	260	4162	262	4248-250	359	4262-5	362
4120-0	261	4163	263	4249-220	359	4262-7	362
4120-1	261	4164	268	4251-175	357	4262-8	362
4120-2	261	4165	264	4252-A0	354	4262-9	362
4120-3	261	4166	264	4252-A1	354	4263	363
4125-08	261	4168	265	4252-A2	354	4263-1	363
4125-10	261	4170	267	4252-A3	354	4263-2	363
4125-15	261	4201-200P	331	4252-A4	354	4263-3	363
4125-20	261	4205-200P	335	4253-A01	354	4263-4	363
4125-25	261	4210-160	343	4253-A11	354	4263-5	363
4125-27	261	4210-210	343	4253-A21	354	4263-6	363
4125-30	261	4211-180	340	4253-A31	354	4263-7	363
4125-40	261	4212-160	340	4253-A41	354	4263-8	363
4126-08	262	4212-180	340	4254-J0	355	4264	364
4126-10	262	4213-180	341	4254-J1	355	4264-1	364
4126-15	262	4213-200	341	4254-J2	355	4264-2	364
4126-20	262	4214-200	334	4254-J3	355	4264-3	364
4126-25	262	4215-205	341	4254-J4	355	4264-4	364
4126-27	262	4216-205	342	4255-J01	356	4264-5	364
4126-30	262	4219-160	342	4255-J11	356	4271-165	331
4126-40	262	4220-250	343	4255-J21	356	4271-180	331
4127-06	268	4222-180	350	4255-J31	356	4271-205	331
4127-07	268	4222-250	350	4255-J41	356	4272-145	332
4127-08	268	4222-300	350	4256-240	357	4272-160	332
4127-10	268	4223-180	349	4260-18	365	4272-180	332
4127-11	268	4223-240	349	4260-18E	365	4272-190	332
4127-12	268	4223-300	349	4260-24	365	4273-180	333
4127-13	268	4223-400	349	4260-24E	365	4273-200	333
4127-055	268	4224	350	4260-30	365	4274-200	333
4128	270	4224-250	350	4260-30E	365	4275-170	335
4130	270	4224-320	350	4260-36	365	4275-205	335
4132	271	4224-400	350	4260-36E	365	4276-205	336
4133B	308	4225-250	352	4260-42	365	4277-160	337
4135	267	4231-115	347	4260-42E	365	4278-160	338
4140-3	259	4232-115	348	4261	361	4279-160	338
4140-4	259	4233-115	345	4261-1	361	4279-180	339

INDEX / INDICE / INDICE

Art. No.	Cat.	Art. No.	Cat.	Art. No.	Cat.	Art. No.	Cat.
4286	356	4405-18	228	4900-27B	51	4900-51P14	426
4320	385	4405-19	228	4900-28B	46	4900-51R	427
4320-1	384	4701-0206	402	4900-28K	228	4900-51S05	426
4320-2	384	4701-0316	402	4900-29B	40	4900-51S06	426
4320-3	384	4701-0519	402	4900-30B	45	4900-51S08	426
4320-4	384	4706-0313	403	4900-30K	241	4900-51S10	426
4320-5	384	4706-0319	402	4900-31B	54	4900-51S12	426
4321	385	4706-0527	402	4900-31K	269	4900-51S14	426
4322	325	4706-0827	402	4900-33B	61	4900-51T05	420
4322-1	323	4711-3013	404	4900-34B	66	4900-51T06	420
4322-2	324	4712-109.5	403	4900-34K	425	4900-51T08	420
4322-3	324	4716-1013	403	4900-35B	55	4900-51T10	420
4322-4	324	4900-01B	39	4900-35K	289	4900-51T12	420
4322-5	324	4900-01K	108	4900-36B	56	4900-51T14	420
4322-6	324	4900-02B	39	4900-36K	290	4900-54B	53
4322-7	325	4900-03B	40	4900-37B	71	4900-54K	266
4325	385	4900-04B	52	4900-38B	41	4900-56B	65
4326	385	4900-04K	265	4900-39B	68	4900-57B1	62
4402-08	226	4900-05B	53	4900-39BS	68	4900-57B2	62
4402-09	226	4900-05K	266	4900-39K	432	4900-57B3	62
4402-11	226	4900-07B	61	4900-39KS	432	4900-58B	41
4402-12	226	4900-08B	63	4900-40B	46	4900-59B	67
4402-14	226	4900-09B	63	4900-40K	222	4900-59K	425
4402-15	226	4900-10B	64	4900-41B	48	4900-60B	52
4402-16	226	4900-11B	65	4900-41K	236	4900-61B	57
4402-17	226	4900-12B	66	4900-42B	60	4900-62B	57
4402-18	226	4900-12K	408	4900-43B	60	4900-63B	58
4402-19	226	4900-13B	44	4900-46B	47	4900-64B	58
4402-20	226	4900-14B	44	4900-46K	234	4900-65B	59
4402-21	226	4900-15B	49	4900-47B	47	4900-66B	65
4402-22	226	4900-15K	246	4900-47K	232	4900-67B	59
4402-24	226	4900-16B	48	4900-48B	50	4900-70B	43
4402-51	227	4900-17B	45	4900-48K	250	4900-71B	43
4402-52	227	4900-17K	225	4900-49B	42	4900-71B1	43
4402-53	227	4900-18B	50	4900-51A412	421	4900-73B	69
4405-08	228	4900-18K	250	4900-51A620	421	4900-74B	70
4405-09	228	4900-19B	56	4900-51A1240	423	4900-75B	70
4405-10	228	4900-20B	42	4900-51B	67	4900E	71
4405-11	228	4900-21B	64	4900-51K	427	4900K	71
4405-12	228	4900-22B	49	4900-51M	427	4902-01	92
4405-13	228	4900-23B	50	4900-51P05	426	4902-02	93
4405-14	228	4900-25B	54	4900-51P06	426	4902-03	93
4405-15	228	4900-25K	274	4900-51P08	426	4902-04	94
4405-16	228	4900-26B	55	4900-51P10	426	4902-05	94
4405-17	228	4900-26K	275	4900-51P12	426	4902-06	95

Art. No.	Cat.	Art. No.	Cat.	Art. No.	Cat.	Art. No.	Cat.
4902-07	95	4920	36	10080	412	11038	415
4902-08	96	4920F	36	10085	412	11039	415
4902-09	97	4931	73	10090	412	11040	415
4902-080	96	5405-250	352	10095	412	11041	415
4902-081	96	5405-290	353	10100	412	11042	415
4902-090	97	5405-350	352	10102	412	11043	415
4902-091	97	5405-450	352	10105	412	11044	415
4903-01	74	5405-600	352	10110	412	11045	415
4903-02	74	5405-900	352	10115	412	11046	415
4903-03	75	5406-320	352	10120	412	11047	415
4903-04	75	5406-420	352	10125	412	11048	415
4903-05	76	5406-540	352	10130	412	11049	415
4903-06	76	5418-300	366	10900	413	11050	415
4903-07	77	5432	377	10903	413	11051	415
4903-08	77	5436	378	10906	413	11052	415
4903-09	81	5440-1	378	10910	414	11053	415
4903-10	81	5440-3	378	10910K	414	11054	415
4903-11	85	5440-5	378	11010	415	11055	415
4903-12	87	5440-5ES	378	11011	415	11056	415
4903-13	88	5441	377	11012	415	11057	415
4903-15	84	5441E	377	11013	415	11058	415
4903-16	78	5451	366	11014	415	11059	415
4903-17	78	5461SET	353	11015	415	11060	415
4903-18	79	5470	380	11016	415	11061	415
4903-19	82	7526	33	11017	415	11062	415
4903-20	82	7527	33	11018	415	11063	415
4903-21	83	10010	412	11019	415	11064	415
4903-22	84	10015	412	11020	415	11065	415
4903-23	87	10020	412	11021	415	11066	415
4903-24	88	10025	412	11022	415	11067	415
4903-25	85	10030	412	11023	415	11068	415
4903-26	86	10032	412	11024	415	11069	415
4903-27	83	10033	412	11025	415	11070	415
4903-28	86	10035	412	11026	415	11071	415
4903-29	79	10040	412	11027	415	11072	415
4903-30	80	10042	412	11028	415	11073	415
4903-31	80	10045	412	11029	415	11074	415
4903-33	89	10048	412	11030	415	11075	415
4903-34	89	10050	412	11031	415	11076	415
4909	34	10055	412	11032	415	11077	415
4911	35	10060	412	11033	415	11078	415
4917	90	10065	412	11034	415	11079	415
4919-01	99	10068	412	11035	415	11080	415
4919-02	100	10070	412	11036	415	11081	415
4919-03	101	10075	412	11037	415	11082	415

INDEX / *INDICE* / INDICE

Art. No.	Cat.	Art. No.	Cat.	Art. No.	Cat.	Art. No.	Cat.
11083	415	13070	417	18340	430	23080	423
11084	415	13075	417	18350	430	23100	423
11085	415	13080	417	18360	430	23120	423
11086	415	13085	417	19001	431	24010	422
11087	415	13090	417	19002	431	24015	421
11088	415	13095	417	19003	431	24110	422
11089	415	13100	417	19004	431	24200	423
11090	415	13102	417	19005	431	25030	421
11091	415	13105	417	19006	431	25040	421
11092	415	13110	417	19190	430	25050	421
11093	415	13115	417	19200	430	25060	421
11094	415	13120	417	19220	430	25080	421
11095	415	13125	417	19250	430	25100	421
11096	415	13130	417	19290	430	25120	421
11097	415	13904	418	19320	430	26030	422
11098	415	13905	418	19350	430	26040	422
11099	415	13910	418	19380	430	26050	422
11100	415	15016	419	19440	430	26060	422
11102	415	15020.5	419	19510	430	26080	422
11105	415	15025	419	19570	430	26100	422
11110	415	15033	419	19650	430	26120	422
11115	415	15042	419	19680	430	28050	426
11120	415	15050	419	19760	430	28060	426
11125	415	15068	419	21030	419	28080	426
11130	415	15085	419	21040	419	28100	426
11904	416	15102	419	21050	419	28120	426
11905	416	18000	428	21060	419	28140	426
11910	416	18010	428	21080	419	29000	295
13010	417	18020	428	21100	419	29010	295
13015	417	18030	428	21120	419	29020	295
13020	417	18100	429	22020	420	29030	295
13025	417	18110	428	22025	420	29100	295
13030	417	18120	428	22030	420	29110	295
13032	417	18130	428	22040	420	29120	295
13033	417	18200	429	22050	420	29130	295
13035	417	18210	429	22060	420	29240	295
13040	417	18220	429	22080	420	29255	295
13042	417	18230	429	22100	420	29265	295
13045	417	18240	429	22120	420	29270	295
13048	417	18250	429	23020	423	29310	296
13050	417	18260	429	23025	423	29315	296
13055	417	18300	430	23030	423	29320	296
13060	417	18310	430	23040	423	29325	296
13065	417	18320	430	23050	423	29327	296
13068	417	18330	430	23060	423	29330	296

Art. No.	Cat.	Art. No.	Cat.	Art. No.	Cat.	Art. No.	Cat.
29340	296	100510	174	106003	179	115309	179
29425	296	100511	174	106004	179	115310	179
29430	296	100599	149	106005	179	115315	179
29440	296	101040	175	106006	179	115320	179
29450	296	101045	175	106007	179	115325	179
29460	296	101050	175	106008	179	115327	179
30001	337	101055	175	106099	151	115330	179
32077-60	32	101060	175	106501	180	115340	179
32077-120	32	101070	175	106502	180	115399	151
38005	109	101080	175	106503	180	120004	177
47120	243	101090	175	106504	180	120005	177
47122	243	101100	175	106505	180	120006	177
47123	243	101110	175	106599	151	120007	177
47124	243	101120	175	107050	180	120008	177
47125	243	101130	175	107100	180	120010	177
90354	31	101503	175	107101	180	120011	177
90359	31	101504	175	107102	180	120099	150
90377	31	101505	175	107140	181, 308	123002	204
99045	156	101506	175	107151	180	123003	209
99046	156	101507	175	107155	181	123102	205
99049	312	101508	175	107330	181	123102-12	205
99067	351	101509	175	107331	182	123102-14	184
99068	318	101510	175	108000	183	123102-38	191
99073	110	101511	175	108100	183	130040	176
100035	174	101599	150	109060	182, 270	130045	176
100040	174	101990	149	109070	182, 270	130050	176
100045	174	102040	178	109080	182, 270	130055	176
100050	174	102055	178	109090	182, 270	130060	176
100055	174	102065	178	109100	182, 270	130070	176
100060	174	103001	178	109110	182, 270	130080	176
100070	174	103002	178	109150	182, 270	130090	176
100080	174	103003	178	109151	182, 271	130100	176
100090	174	104000	178	109175	183, 271	130110	176
100100	174	104001	178	110000	183	130120	176
100110	174	104002	178	115008	179	130130	176
100120	174	104003	178	115009	179	130140	176
100130	174	105008	178	115010	179	130990	149
100140	174	105010	178	115015	179	200060	185
100503	174	105015	178	115020	179	200070	185
100504	174	105020	178	115025	179	200080	185
100505	174	105025	178	115027	179	200090	185
100506	174	105027	178	115030	179	200100	185
100507	174	105030	178	115040	179	200110	185
100508	174	105040	178	115099	150	200120	185
100509	174	105099	150	115308	179	200130	185

INDEX / *INDICE* / INDICE

Art. No.	Cat.	Art. No.	Cat.	Art. No.	Cat.	Art. No.	Cat.
200140	185	201515	186	206010	189	300180	193
200150	185	201516	187	206099	153	300190	193
200160	185	201517	186	206501	189	300200	193
200170	185	201599	152	206502	189	300210	193
200180	185	201990	152	206503	189	300220	193
200190	185	201998	152	206504	189	300240	193
200200	185	202055	188	206505	189	300270	193
200210	185	202065	188	206507	189	300300	193
200220	185	202080	188	206509	189	300320	193
200240	185	203001	188	206599	153	300340	193
200505	185	203002	188	207075	190	301100	193
200507	185	203003	188	207076	190	301110	193
200509	185	204001	188	207150	190	301116	193
200510	185	204002	188	207151	190	301120	193
200511	185	204003	188	207152	190	301130	193
200512	185	205010	188	207250	190	301140	193
200513	185	205015	188	207251	190	301150	193
200514	185	205020	188	207252	190	301160	194
200515	185	205025	188	208000	191	301170	193
200516	185	205027	188	210000	191	301180	193
200517	185	205030	188	211516	192, 306	301190	193
200518	185	205040	188	212650	191	301210	194
200519	185	205045	188	213814	192	301220	193
200599	151	205050	188	220004	187	301990	154
201080	186	205055	188	220005	187	301998	155
201100	186	205060	188	220006	187	302055	300
201110	186	205099	153	220007	187	302065	300
201114	186	205310	189	220008	187	302080	300
201118	186	205315	189	220010	187	302100	300
201120	186	205320	189	220011	187	302120	300
201130	186	205325	189	220012	187	303001	300
201140	186	205327	189	220014	187	303002	300
201150	186	205330	189	220016	187	303003	300
201160	186	205340	189	220018	187	303004	300
201170	186	205345	189	220020	187	304001	300
201180	186	205350	189	220099	152	304002	300
201190	186	205355	189	300080	193	304003	300
201210	186	205360	189	300100	193	304004	300
201220	186	205399	153	300110	193	305010	301
201509	186	206003	189	300120	193	305015	301
201510	186	206004	189	300130	193	305020	301
201511	186	206005	189	300140	193	305025	301
201512	186	206006	189	300150	193	305027	301
201513	187	206007	189	300160	193	305030	301
201514	186	206008	189	300170	193	305040	301













Art. No.	Cat.	Art. No.	Cat.	Art. No.	Cat.	Art. No.	Cat.
305045	301	310000	205	320022	197	329099	157
305047	301	311340	207	320024	197	330100	194
305050	301	311380	207	320099	155	330110	194
305055	301	311516	207, 306	325010	198	330120	194
305060	301	313001	300	325015	198	330130	194
305070	301	313002	300	325020	198	330140	194
305080	301	313003	300	325025	198	330150	194
305090	301	314001	301	325027	198	330160	194
305100	301	314002	301	325030	198	330170	194
305310	302	315015	302	325040	198	330180	194
305315	302	315020	302	325045	198	330190	194
305320	302	315025	302	325050	198	330200	194
305325	302	315027	302	325055	198	330210	194
305327	302	315030	302	325060	198	330220	194
305330	302	315040	302	325070	198	330240	194
305340	302	315045	302	325099	155	330270	194
305345	302	315050	302	325380	199	330300	194
305350	302	315055	302	325381	199	330320	194
305355	302	315060	302	326005	200	330990	154
305360	302	315070	302	326006	200	330991	154
305370	302	315080	302	326007	200	335010	198
306003	303	315090	302	326008	200	335015	198
306004	303	315100	302	326010	200	335020	198
306005	303	315320	303	326012	200	335025	198
306006	303	315325	303	326014	200	335027	198
306007	303	315327	303	326017	200	335030	198
306008	303	315330	303	326099	156	335040	198
306010	303	315340	303	328005	201	335045	198
306012	303	315345	303	328006	201	335050	198
306014	303	315350	303	328008	201	335055	198
306501	304	315355	303	328010	201	335060	198
306502	304	315360	303	328012	201	335099	156
306503	304	316004	303	328014	201	335370	199
306504	304	316005	303	328016	201	336005	200
306505	304	316006	303	328099	157	336006	200
306507	304	316007	303	329005	202	336007	200
306509	304	316008	303	329006	202	336008	200
307125	203	316010	303	329007	202	336010	200
307126	203	316012	303	329008	202	336012	200
307127	204	320010	197	329009	202	336099	157
307250	203	320012	197	329010	202	338005	201
307251	203	320014	197	329011	202	338006	201
307252	204	320016	197	329012	202	338008	201
308000	205	320018	197	329013	202	338010	201
308001	205	320020	197	329014	202	338012	201









INDEX / INDICE / INDICE

Art. No.	Cat.	Art. No.	Cat.	Art. No.	Cat.	Art. No.	Cat.
338099	157	380320	195	385030	199	400002	164
339005	202	381000	206	385040	199	400002E	164
339006	202	381003	208	385045	199	400003	164
339007	202	381005	126	385050	199	400005	129
339008	202	381012	208	385055	199	400015	129
339009	202	381014	208	385060	199	400190	209
339010	202	381038	208	385070	199	400210	209
339011	202	381080	196	385080	199	400220	209
339012	202	381090	196	385090	199	400230	209
339013	202	381099	155	386003	200	400240	209
339014	202	381100	196	386004	200	400260	209
339099	158	381103	208	386005	200	400270	209
345330	199	381110	196	386006	200	400290	209
345340	199	381112	208	386007	200	400300	209
345345	199	381114	208	386008	200	400320	209
348005	304	381120	196	386009	200	400350	209
348006	304	381130	196	386010	200	400360	209
348008	304	381138	208	386012	200	400380	209
348010	304	381140	196	386014	200	400410	209
348012	304	381150	196	386016	200	400460	209
349005	304	381150-0	196	386017	200	400500	209
349006	304	381160	196	387125	204	407100	212
349008	304	381170	196	387200	171	407102	212
349010	304	381170-0	196	387998	206	407200	212
349012	304	381180	196	387999	206	407202	212
380005	126	381190	196	388004	201	407400	212
380080	195	381190-0	196	388005	201	407402	212
380090	195	381200	196	388006	201	408000	212
380100	195	381210	196	388008	201	408002	213
380110	195	381210-0	196	388009	201	411100	213
380120	195	381220	196	388010	201	411120	213
380130	195	381220-0	196	388012	201	480170	210
380140	195	381230	196	388014	201	480190	210
380150	195	381240	196	388016	201	480200	210
380160	195	381240-0	196	388018	201	480210	210
380170	195	381270	196	389004	203	480220	210
380180	195	381300	196	389005	203	480230	210
380190	195	381320	196	389006	203	480240	210
380200	195	381340	207	389007	203	480250	210
380210	195	381516	207	389008	203	480260	210
380220	195	385010	199	389009	203	480270	210
380230	195	385015	199	389010	203	480280	210
380240	195	385020	199	389012	203	480290	210
380270	195	385025	199	389013	203	480300	210
380300	195	385027	199	389014	203	480320	210



Art. No.	Cat.	Art. No.	Cat.	Art. No.	Cat.	Art. No.	Cat.
480330	210	500002E	165	581340	215	597075	181
480340	210	500015	129	581360	215	600000	165
480350	210	500360	214	581380	215	600100	187
480360	210	500380	214	581410	215	600110	187
480380	210	500410	214	581460	215	600120	187
480410	210	500460	214	581500	215	600130	187
480460	210	500500	214	581550	215	600140	187
480500	210	500540	214	581600	215	600150	187
481000	213	500550	214	581650	215	600160	187
481170	211	500580	214	581700	215	600170	187
481180	211	500600	214	581750	215	600180	187
481190	211	500630	214	581800	215	600190	187
481210	211	500650	214	581850	215	607075	190
481220	211	500670	214	581900	215	610000	165
481240	211	500700	214	587200	216	610190	197
481260	211	500710	214	590000	165	610200	197
481270	211	500750	214	590035	177	610210	197
481290	211	500770	214	590040	177	610220	197
481300	211	500800	214	590045	177	610240	197
481320	211	507200	216	590050	177	610270	197
481350	211	507400	216	590055	177	610300	197
481360	211	508000	216	590060	177	610320	197
481380	211	511340	216	590070	177	610340	197
481410	211	581000	216	590080	177	611120	208
481460	211	581034	216	590090	177	611140	192
481500	211	581220	215	590100	177	611380	192
483410	213	581240	215	590110	177	617075	204
483412	214	581270	215	590120	177	617150	204
487100	212	581300	215	590130	177		
487200	212	581320	215	591140	184		
500002	165	581330	215	592760	184		

Technical characteristics
Características técnicas
Características técnicas

DIN	Produced according to DIN specifications <i>Fabricado según normas DIN</i> Produzido sobre as normas DIN
ISO	Produced according to ISO specifications <i>Fabricado según normas ISO</i> Produzido sobre as normas ISSO
	TÜV-GS - approved <i>Aprobado TÜV-GS</i> TUV-GS aprovado
	Weight <i>Peso</i> Peso
	Dimensions <i>Dimensiones</i> Dimensões
	Inch - sizes <i>Dimensiones - pulgadas</i> Medidas em polegadas
	Per revolution <i>Por giro</i> Para rodar
XXL	Extra long pattern <i>Modelo extra largo</i> Modelo extra longo
XS	Short pattern <i>Modelo corto</i> Modelo curto
	Ratchet mechanism, teeth per revolution <i>Mecanismo carraca, numero dientes por giro</i> Mecanismo de roquete, quantidade de dentes por volta
	Magnetic <i>Imantado</i> Magnético
	Usage with impact wrench <i>Uso con llaves de impacto</i> Uso com chave impacto
	Cable <i>Cable</i> Cabo
	Copper wire <i>Alambre cobre</i> Fio de Cobre
	Soft wire <i>Alambre blando</i> Fio macio
	Medium hard wire <i>Alambre semi duro</i> Arame Médio - Duro
	Hard wire <i>Alambre duro</i> Fio duro

	Piano wire <i>Cuerda piano</i> Corda de piano
	Steel wire <i>Alambre acero</i> Fio de aço
	Locking device <i>Bloqueo</i> Sistema de fecho
	Chrome-vanadium <i>Cromo-Vanadio</i> Chrome-Vanadium
	Chrome-molybdenum <i>Cromo-molibdeno</i> Chrome-Molybdenum
	VDE-approved 110-250V <i>Aprobado VDE - 110-250V</i> VDE aprovado 110-250V
	Produced/approved acc. to DIN/EN 60900 for working at voltage of AC 1000V and DC 1500V <i>Fabricado/Aprobado según DIN/EN 60900 para trabajos bajo tensión de AC 1000V y DC 1500V</i> Produzido/Aprovado de acordo DIN/EN 60900 para trabalho a voltagem AC1000V e DC1500V
	
	S2 steel (chrome-silicium-manganese-molybdenum-vanadium-steel) <i>Acero S2</i> <i>(acero cromo-silicio-manganeso-molibdeno-vanadio)</i> Aço S2 (aço-cromio-silicium-manganês-molibdenio-vanádio)
	ESD-handle against electrostatic. Does not provide protection for electric voltage! <i>Mango ESD contra electricidad estática.</i> <i>Sin protección para tensión eléctrica!</i>
	
	ESD-cabo contra electricidade estática. Não fornece protecção contra voltagem electrica!

Commercial characteristics
Características comerciales
Características comerciais

	Pieces per item <i>Piezas por unidad</i> Peças por unidade
	Assembly number <i>Número piezas</i> Numero de peças

Conditions are subject to stock availability.
Modelos susceptibles de cambios segun disponibilidad.
 Sujeito a alterações de mod elos e disponibilidade em stock.

KRAFTWERK®

FAVORITE TOOLS SINCE 1979

KRAFTWERK tools - your constant and dependable companions

Herramientas KRAFTWERK - siempre resistentes y fiables

Ferramentas KRAFTWERK - fieis e de confiança



KRAFTWERK®

FAVORITE TOOLS SINCE 1979



Your specialized dealer: | *Su distribuidor especializado:* |
O seu Distribuidor: